

# The Wireless World

AND RADIO REVIEW

4<sup>D</sup>

*The Paper for Every Wireless Amateur*

Wednesday, January 1st, 1930.



**TONE  
VOLUME  
DISTANCE**  
PUT NEW LIFE  
INTO YOUR RECEIVER

**Mullard**  
THE MASTER-VALVE

**NO MORE BATTERIES  
WITH YOUR  
PORTABLE  
SET**

*Run it off your  
Mains with an*



**EKCo** H.T. UNIT  
FOR D.C. or A.C. Mains

*Write for Free Booklet on "All-Electric Radio" to:*  
E. K. Cole, Ltd., Dept. W, "EKCO" Works, Leigh-on-Sea.

**"Utility"  
"MITE"**



The famous "Utility" Mite Condenser and NEW DRUM DIAL. The Component that created the keenest interest at Olympia! Readings appear through the central aperture, simplifying easy tuning; saves valuable space. Supplied for left or right hand operation.

Cat. No.	Cap.	Price.
W.201	0005	11/6
W.202	0003	11/-
W.203	0002	10/6

Write for fully illustrated Lists.

Prov. Pats. Nos. 37475/28 and 37476/28.

**WILKINS & WRIGHT LTD**  
HOLYHEAD *Utility* BIRMINGHAM

*Green for  
Safety!*



**T.C.C.**  
0003 MFD

**CONDENSERS**

Advt. Telegraph Condenser Co. Ltd.,  
Wales Farm Rd., N. Acton, London, W.3.

CA 3071

# DUBILIER

**CONDENSERS**  
ARE USED IN ALL THE MOST  
SELECTIVE SETS.

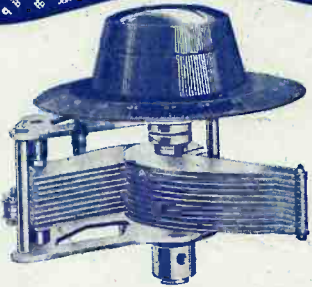

### K.C. CONDENSER

With knob, dial and slow-motion device, .0003 or .0005 **12/-**  
Without knob, dial or slow-motion device, .0003 or .0005 **8/-**

### K.C. DRUM CONTROL CONDENSERS

With Drum Control and slow-motion device, .0003 or .0005 **15/6**  
Triple K.C. each condenser, .0003 or .0005 **38/6**  
Triple K.C. Combinations of .0003 and .0005 **40/-**

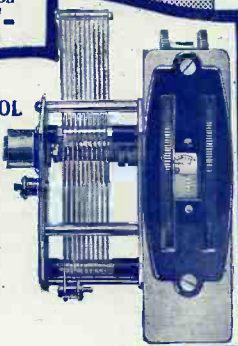

### MIDGET CONDENSER

A small variable condenser for panel mounting, .00005, .0001 or .0002 **5/6**

Ask your dealer for the Dubilier Booklet—  
"A Bit about a Ball-  
ery"—It's free.  
If you have any difficulty in obtaining Dubilier products write to his name and address.

# DUBILIER

CONDENSER CO. (1925) LTD.  
Ducon Works, Victoria Road,  
North Acton, London, W.3.

BC 275/v.

170

# THE NEW CELESTION LOUDSPEAKER

## Z.20.

Holds undisputed rank as the finest of all Loudspeakers

"Finest loud-speaker I have heard . . . sets entirely new standard . . . worth every penny it costs."  
"Help Yourself" Annual.

"Nearest approach to the ideal that I have yet heard."  
"Sphere."

"Most critical musician could not find fault . . ."  
"Evening Chronicle."

Sets a standard. Amazingly true reproduction. Low frequencies as well as high."  
"Daily Mirror."

"Renowned for brilliancy and quality . . . speech and music particularly good . . . a handsome instrument."  
PERCY HARRIS in "Wireless Constructor."

Designed specifically to give the finest possible results with any set from a Two-Valver to a Power Amplifier. Crowned with the Celestion hallmark—a beautifully designed and hand-polished cabinet.

In Oak £7 : 15 : 0,  
Mahogany £8 : 5 : 0,  
Walnut (to order)  
£9 : 0 : 0.

Other Celestion models from £3 : 15 : 0.

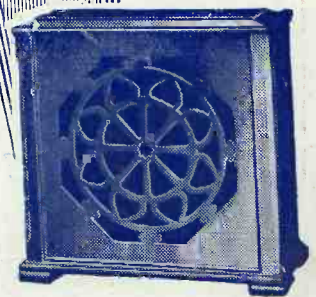

WRITE FOR AN ABSORBING FREE BOOK ON "SOUND RE-CREATION"

# CELESTION

*The Very Soul of Music*

London Showrooms:  
106, Victoria Street, S.W.1.

Write to: Celestion Ltd.,  
Dept. C. Kingston-on-Thames.

**FOREMOST NAME IN SOUND REPRODUCTION**

# This Latest Curve Beats All

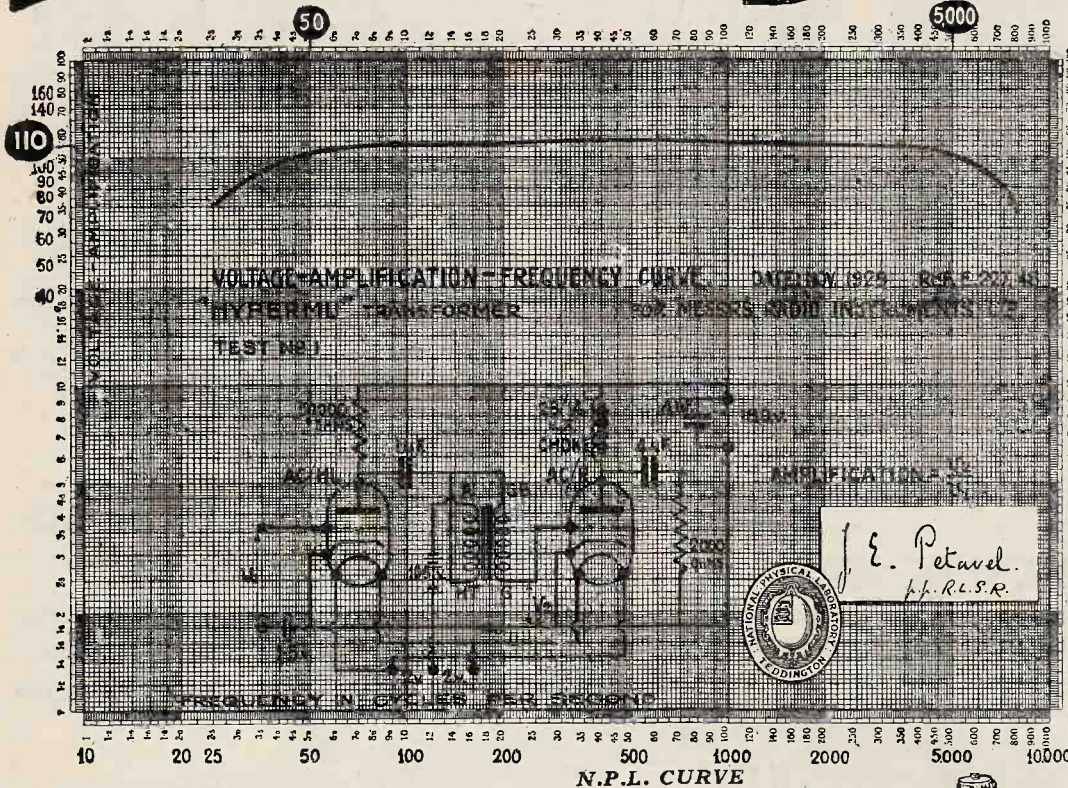

At the request of many interested users we are now publishing by the courtesy of the N.P.L. one of the latest "Hypermu" N.P.L. voltage amplification curves taken with the famous A.C.H.L. indirectly-heated Cosmos valves.

## ASTOUNDING N.P.L. TEST RESULTS PROVE "HYPERMU" PERFORMANCE TO BE ABSOLUTELY INIMITABLE

This curve adequately embraces the whole useful range of frequencies. It shows a voltage amplification of 70 at 25 cycles whilst between 50 and 5,000 cycles it denotes the amazing amplification of 110 expressed in a straight line indicating absolute uniformity between these limits. At 8,000 cycles it is the same as at 25 cycles.

This curve which eclipses any other published by Radio manufacturers throughout the world will be augmented by the publication of further equally amazing "Hypermu" curves taken in conjunction with other indirectly-heated valves and also the P.M.4.DX.

Obtain free copies of the 4 latest curves from your Radio Dealer



# HYPERMU L.F. TRANSFORMER

The most remarkable nickel alloy transformer. Gives the highest and most uniform amplification of any commercial intervalve transformer, and is recommended as best for all modern receiver circuits. Metal screened and encased in Bakelite, weight 14 ozs. Size 3" x 1 1/2" x 3".

21' -

12, HYDE ST., LONDON, W.C.1.

Advertisements for "The Wireless World" are only accepted from firms we believe to be thoroughly reliable.



## FOR ELIMINATOR CIRCUITS

You cannot afford to use any but the best Condenser in an eliminator circuit.

### HELSEBY CONDENSERS

are made and guaranteed by a firm with 30 years' experience in condenser making, from small telephone and radio condensers to Power Condensers weighing upwards of 2 tons.

Guaranteed working voltages :-

Type M	-	-	150 volts D.C.
Type 2A	-	-	350 volts D.C.
Type 3A	-	-	450 volts D.C.
Type 4A	-	-	600 volts D.C.

All Helsby Condensers are vacuum dried and impregnated with a special non-hygroscopic material which renders them moisture proof.

If unobtainable from your dealer, write to us giving his name and address.



## BRITISH INSULATED CABLES LTD

PRESCOT - LANCs.

Makers of PRESCOT and HELSEBY cables

# ELECTRAD

## TRUVOLT Resistances

Truvolt wire-wound potentiometers simplify the construction of H.T. Eliminators and do away with all guesswork. The resistance element is a nickel alloy wire. There is no iron to rust or zinc to oxidise. Truvolts are air-cooled and give a positive and lasting service. All Truvolts are rated at 25 watts.



### REDUCED PRICES.

Type T.5.	500 ohms.	224 m.a.	8/6 each
" T.10	1,000 "	158 "	8/6 "
" T.20	2,000 "	112 "	8/6 "
" T.25	2,500 "	100 "	8/6 "
" T.30	3,000 "	91 "	8/6 "
" T.50	5,000 "	71 "	8/6 "
" T.75	7,500 "	58 "	8/6 "
" T.100	10,000 "	50 "	8/6 "
" T.200	20,000 "	25 "	8/6 "
" T.250	25,000 "	32 "	8/6 "
" T.500	50,000 "	225 "	8/6 "

Write for our new 68-page Catalogue and Audio Manual. It tells you all about the uses of Electrad resistances. Post Free 6d.

THE ROTHERMEL CORPORATION LTD.,  
24, Maddox Street, London, W.1.

'Phone: Mayfair 0578/9.

## THE BEST OF THE BRITISH UNITS.

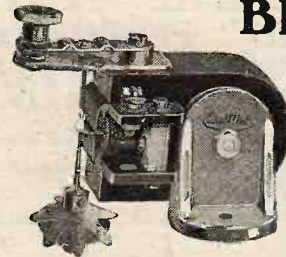

# 18/6

complete with cone clamps and aluminium brackets as shown, enabling exact centre adjustment to be made.

Before you buy a unit for your cone speaker, send for a leaflet on this Watmel Unit. Both in theory and in practice this is the best unit yet turned out either in this or in any other country.

Magnets of Cobalt Steel, pole pieces of turbo stalloy, armature of best charcoal annealed iron, positive adjustment and true four-pole action combine to make this a unit of outstanding performance and sensitivity. Fully descriptive folder No. 101 comes free on application, and shows you how you can build a complete loud speaker, including magnificent oak cabinet, from a kit of parts costing only 55/-.

WATMEL WIRELESS CO., LTD., Imperial Works,  
High St., Edgware, Mx.

Telephone: Edgware 0323.

P & T

# The FERRANTI Multi-Range Test Set



The instrument has a most handsome appearance and is of convenient size, measuring 6" x 5" x 2", and weighing only 1 lb. 7 ozs. It is a universal testing instrument of immense value to the man who wants to ascertain facts and eliminate guess-work.

The Multi-Range Test Set is the latest addition to the range of FERRANTI Radio Meters, and it is an instrument of which we are justifiably proud. It fully maintains the high traditions of scientific design and manufacturing skill for which the makers of the famous AF3 are renowned, and in the hands of the serious experimenter it has many applications. In fact, there is no direct current measurement—current, pressure, power, or resistance—up to 25 amps., 250 volts, that may not be measured by this instrument. An even greater and almost unlimited range may be obtained by the employment of external shunts and resistances.

The Multi-Range Test Set comprises two FERRANTI Radio Meters—an ammeter and a voltmeter—mounted side by side in a moulded bakelite case with the terminals so arranged that current and voltage readings may be taken simultaneously. By means of rotary switches mounted on the instrument a wide range of readings is obtainable.

- |                 |                  |             |
|-----------------|------------------|-------------|
| 0.1 milliamp    | 0.5 amperes      | 0.1 volt    |
| 0.10 milliamps  | 0.10 amperes     | 0.5 volts   |
| 0.50 milliamps  | 0.25 amperes     | 0.10 volts  |
| 0.100 milliamps | 0.75 millivolts  | 0.50 volts  |
| 0.500 milliamps | 0.100 millivolts | 0.100 volts |
| 0.1 ampere      | 0.500 millivolts | 0.250 volts |

**PRICE**

Without Case and Leads, £7 15 0 : With Case and Leads, £9 5 0

Write for leaflet We. 406.

FERRANTI LTD.

HOLLINWOOD

LANCASHIRE

# Radio's Supreme Power



ARE YOU PROUD  
OF YOUR NEW SET?  
DO IT JUSTICE  
AND FIT THE BEST  
POSSIBLE BATTERY

Grosvenor Batteries give continuous and satisfactory service because they incorporate a new vitalising element which is unique to Grosvenor.

66 v. from 7/6	Super Capacity for Multi-Valve Sets	66 v. 20/-
99 v. .. 11/6		99 v. 32/6



# The Grosvenor Battery

BRITISH MANUFACTURE

GROSVENOR BATTERY CO., LTD., 2-3, White St., MOORGATE, LONDON, E.C.2. Phone: Met. 6866

A3 Advertisements for "The Wireless World" are only accepted from firms we believe to be thoroughly reliable.

**THE  
POPULAR  
LOTUS  
ALL ELECTRIC  
RECEIVER**  
for  
**£19-9**  
DOWN

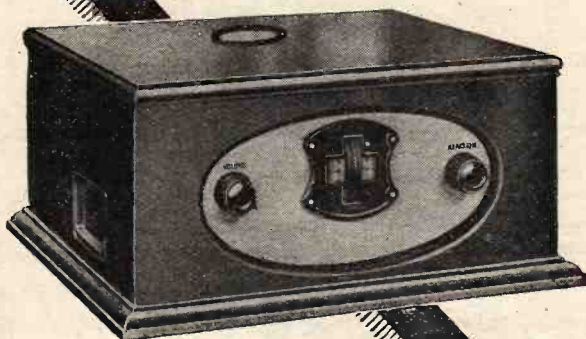

Easily operated by connecting to any A.C. Mains light socket—no batteries needed—this Lotus All Electric 3-valve S.G.P. Set is highly selective and covers a good range of British and Continental stations. Cash price £21 (Royalties paid, and including valves). The same circuit is used in the Lotus 3-valve S.G.P. Battery Model—Cash price £13 : 15 : 6.

For home construction get the Lotus 3-valve S.G.P. Battery Model Kit at £7 : 12 : 6. See and hear it at any wireless dealer's or write to-day for the Lotus Sets Catalogue and Hire Purchase terms.

**LOTUS**  
**ALL ELECTRIC  
RECEIVER**

*Gets the best reception.*

*Made by the makers of the famous Lotus components in one of the most modern radio factories in Great Britain.*

**GARNETT WHITELEY & CO., LTD., Dept. W.W.4,**  
Lotus Works, Mill Lane, Liverpool.

Caution

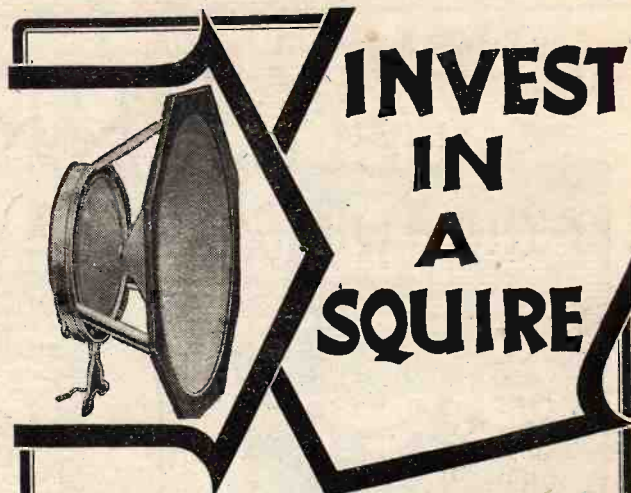

**INVEST  
IN  
A  
SQUIRE**

**SQUIRE** Cone Speakers are a good investment from all points of view. For a very small expenditure they will bring you in reproduction that is only equalled by the most expensive speakers on the market. We make this claim with the utmost confidence, because it has been tested and proved true. There is a Squire Speaker to suit every purse and every requirement. Ask your dealer to demonstrate one and prove our claims for yourself. The 101 is illustrated above.

Retail Prices.  
Price of Cradle complete with Cones, Octagonal front and enamelled back—**2 Gns.** (including Royalty)

Set of four oxy silver chains 3/8; Art silk lamp shade fringe 4/-; Kit for making two cones 7/8.

**Fredk. Squire Ltd.,**  
10, Leswin Place, Stoke Newington, N.16.

P. & T.

An entirely new M-L production for the **ALL ELECTRIC RECEIVER**, the D.C. to A.C. Converter.

**40 WATT Model**  
£13-0-0

**85 WATT Model**  
£19-0-0

*Power Supply Units our Speciality.*

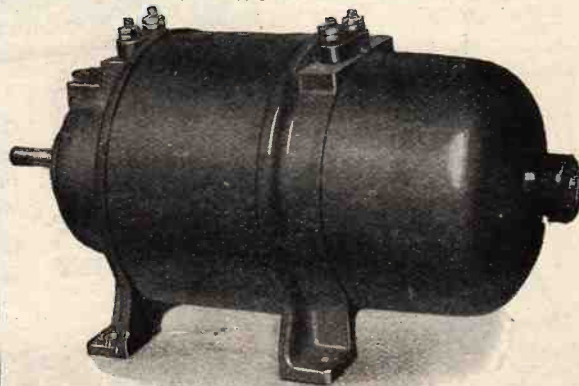

IF YOU ARE ON D.C. MAINS employ the above machine for running your **ALL ELECTRIC RECEIVER**. The only safe way to operate receivers from D.C. Mains. Suitable for well-known makes of Receivers

**M-L MAGNETO SYND. Ltd.,**  
**Radio Dept., COVENTRY.**

Telephone : 5001.

Mention of "The Wireless World," when writing to advertisers, will ensure prompt attention.

# SPECIALLY SELECTED for the Twin Station 2



**BURTON ANTI-CAPACITY SWITCH.**

Maximum efficiency in minimum of space. Nickel Plated Finish.

3 way 6/- 4 way 7/-



**HERE IS THE NEW BURTON DIFFERENTIAL CONDENSER.**

The best differential condenser yet made! More accurate and easier for tuning, better selectivity and less oscillation. The price is only 5/-

These famous Burton Components were specially selected by the designer for the building of the Twin Station Two (see "Wireless World," December 25th). Burton Components are a vital factor in any set. Make sure you use Burton Components! Feel the confidence of Burton's behind you!

**BUY BY THE  
BURTON  
NAME**



**THE BURTON VALVE HOLDER.**  
Self-locating; means prolonged life for your valves. Complete with 1/- fixing screws

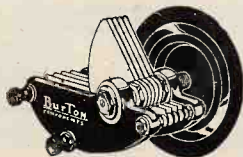

**THE BURTON REACTION CONDENSER.**  
Capacity 0001, panel mounting type 4/-

**BUY  
BURTON  
COMPONENTS**

C. F. & H. BURTON, Progress Works, Walsall.

# STANDARDS

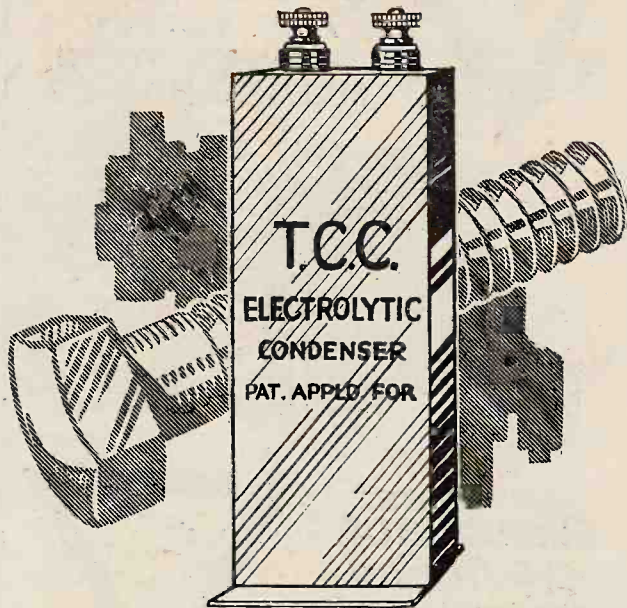

**THREADS per INCH  
and T.C.C.**

WITHOUT standardization in screw threads no engineering job could proceed. It is essential to know when a certain size of nut or bolt is specified that that size will be supplied.

The same holds good with condensers. When you ask for a condenser of a certain capacity tested at a given voltage you expect to receive such a condenser. If it's a T.C.C. you are assured of it being "up to specification." The "condenser in the green case" has for years been recognised as the standard condenser. For accuracy, safety, and dependability specify T.C.C. always.

The illustration above shows an Electrolytic Type Condenser. These are made in three capacities, viz. :- Single Type 2,000 mfd 12 volts D.C., price 15s. od. Double Type 4,000 mfd 12 volts D.C., price 27s. 6d, and the new Single Type 500 mfd 40 volts D.C., price 20s. od.



A div. Telegraph Condenser Co Ltd., Wales Farm Road, N. Acton, London, W. 3.



3070

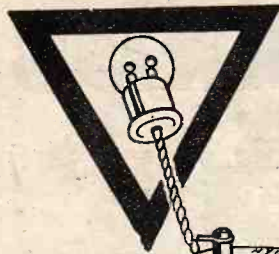

**PUT HYDRA**  
*for safety*  
**BETWEEN YOUR MAINS AND SET**

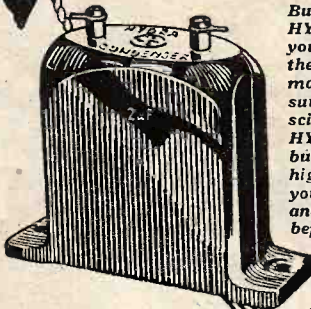

Build an eliminator with HYDRA Condensers and you are putting between the high voltage of your mains and your set the surest safeguard that science can provide. HYDRA Condensers are built to stand up to higher pressures than your mains supply—and every one is tested before it leaves the factory—tested far beyond its stated working voltage.

Fit HYDRA for safety.

In all the best ELIMINATORS you'll find

**HYDRA CONDENSERS**

LOUIS HOLZMAN, 37, Newman Street, London, W.1.

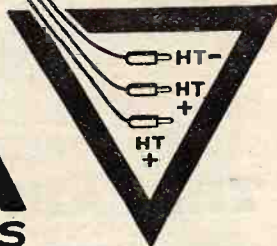

Fit the **DUBILIER**  
*long-life*  
**BATTERY**



Other Voltages Available.

Dubilier Condenser Co. (1925). Ltd., Ducon Works, Victoria Road, North Acton, London, W.3.

**66 Volts**  
**7/9**

BRITISH MADE

and improve the quality of your reception

66 VOLTS  
PRICE 7/9  
EMF. HIGH READING 6.4  
CODE NO 166

Ask your dealer for a copy of the Dubilier Booklet — "A Bit about a Battery."

**BRITKAM**

SUPER QUALITY  
**EBONITE**  
IN SHEETS, RODS,  
AND TUBES.

PANELS cut to any size and thickness. Matt or polished surface. Guaranteed against surface leakage. Immediate delivery. Prices on application.

Trade enquiries invited.

**BRITKAM-EBONITE** (Britannia Rubber & Kamptulicon Co. Ltd.)  
7, Newgate Street, London, E.C.1.

**REMEMBER**



**WHEN BUYING WIRELESS MAINS COMPONENTS!**

If you see PARMEKO on the transformer, choke or eliminator, you know you are buying the highest class of apparatus. PARMEKO components are made to the designs of technical

experts by skilled workmen, only the finest materials being used. Though our range of models is one of the widest, we are one of the few firms which make a speciality of apparatus to your own specification. Let us know your requirements and we will quote by return.

For the benefit of our London customers we carry stocks of our apparatus at 74, New Oxford Street, where we shall be pleased to see anyone interested at any time.

**PARTRIDGE & MEE Ltd.,**

26, Dover Street, LEICESTER.

74, New Oxford Street, LONDON, W.C.1.



THE BEST PANELS—NOW THE CHEAPEST.

Trelleborg Ebonite Works, Ltd., Union Place, Wells Street, London, W.1

Highly Polished 3/16" Black or Wavy, 9/16d. sq. in., 6x9, 2/6; 7x14, 4/6; 7x18, 6/-; 7x21, 7/-; 8x12, 4/6; 8x16, 6/-; Highly Polished, 3/16" Mahogany, 1/4" Black or Wavy, 1d. sq. in., 6x9, 3/6; 7x14, 6/3; 7x18, 8/-; 7x21, 9/3; 8x12, 6/-; 8x16, 8/-; Highly Polished, 1/4" Mahogany, 1d. sq. in., 6x9, 4/6; 7x14, 8/2; 7x18, 10/6; 7x21, 12/8; 8x12, 8/-; 8x16, 10/8.

Mention of "The Wireless World," when writing to advertisers, will ensure prompt attention.





Patent 271,384.

Lewcos Centre-tapped Coil No. 40 was specified for use in the two-valve set described in "The Wireless World," December 26.



# Maximum inductance!

assured with Lewcos Centre Tapped Coils.

Lewcos Centre Tapped Coils ensure at all times the maximum inductance with the minimum self capacity. Lewcos Coils provide you with every quality that makes for selective tuning, together with greater volume and purity of tone. Coils No. 25 to 75, 3/6 each. Coils No. 100 to 200, 4/6 each. Coils No. 250 to 300, 5/3 each.

## LEWCOS

REGD.

H.F. CHOKE CURVES  
Showing the performance of the Lewcos H.F. Choke compared with other makes

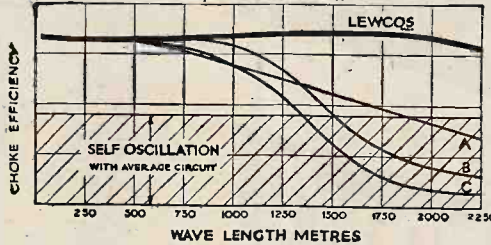

### LEWCOS H.F. CHOKE.

The Lewcos H.F. Choke gives efficient performance on all wave-lengths from 2,000 down to 20 metres. Size 1 1/2" x 2 1/2" x 3 3/8" high. Price 7/9 each.

LEWCOS POTENTIOMETER.  
Patent No. 740579.

The Lewcos Fixed Potentiometer gives perfectly smooth reaction control on all Radio receivers. Price 4/9 without Grid Leak.

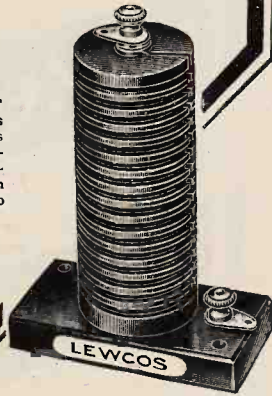

THE LONDON ELECTRIC WIRE COMPANY AND SMITHS LIMITED,  
Church Road, Leyton, London, E.10.  
Trade Counter: 7, Playhouse Yard, Golden Lane, E.C.1.

## Pertrix once —

## Pertrix always

### The Battery without CRACKLE

**60%**  
LONGER LIFE

Once use a "Pertrix" H.T. Battery and no other will content you. Being devoid of the ordinary sal-ammoniac electrolyte, "Pertrix" possesses these unique qualities:

- (a) It cannot develop "crackle."
- (b) It cannot lose power when out of circuit.
- (c) It gives—on every test—60% longer life.



# PERTRIX

SUPER  
H.T. BATTERIES

PERTRIX Ltd., Britannia House, Shaftesbury Avenue, London, W.C.2  
Factory—Britannia Works, Redditch, Worcs.

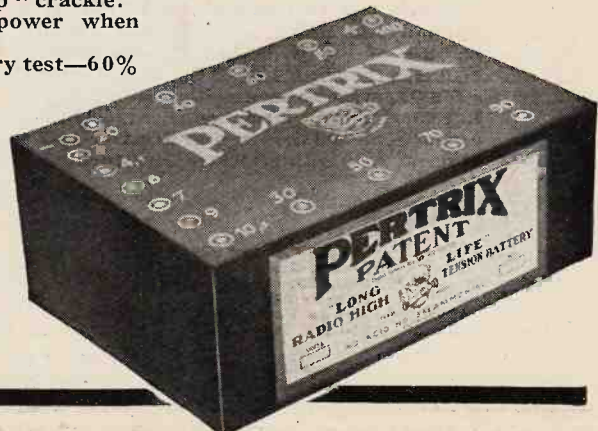

**LOCKED for SAFETY!**

**LOCKED for RIGIDITY!**

**LOCKED for LONG LIFE!**



**T**HE NEW Cossor Screened Grid Valve is shock-proof, noise-proof and break-proof. Its Interlocked Construction makes it the strongest and most robust Screened Grid Valve ever produced. Its elements are immovably locked in position—vibration is impossible—all risk of microphonic noise is eliminated. And because of the girder-like rigidity of its elements the NEW Cossor has exceptional strength, even the hardest blow cannot mar its remarkable performance. Use the NEW Cossor Screened Grid in your Receiver—no other make has Interlocked Construction.

The NEW Cossor 220 S.C.  
(2 volts, .2 amp.) Impedance  
200,000. Amplification  
Factor 200.  
Anode Volts 22/6  
120-150. Price

Cossor 4- and 6-volt  
Screened Grid Valves are  
also obtainable from all  
Wireless Dealers.

# The NEW COSSOR Screened Grid Valve

A. C. Cossor Ltd., Highbury Grove, London, N.5.

Mention of "The Wireless World," when writing to advertisers, will ensure prompt attention.

 2996

48

# The Wireless World

AND  
RADIO REVIEW  
(17<sup>th</sup> Year of Publication)

No. 540.

WEDNESDAY, JANUARY 1ST, 1930.

VOL. XXVI. No. 1.

Editor: HUGH S. POCOCK.

Assistant Editor: F. H. HAYNES.

Editorial Offices: 116-117, FLEET STREET, LONDON, E.C.4

Editorial Telephone: City 9472 (5 lines).

Advertising and Publishing Offices:

DORSET HOUSE, TUDOR STREET, LONDON, E.C.4.

Telephone: City 2847 (13 lines). Telegrams: "Ethaworld, Fleet, London."

COVENTRY: Hertford Street.

Telegrams: "Cyclist, Coventry." Telephone: 5210 Coventry.

BIRMINGHAM: Guildhall Buildings, Navigation Street.

Telegrams: "Autopress, Birmingham." Telephone: 2970 and 2971 Midland.

MANCHESTER: 260, Deansgate.

Telegrams: "Hife, Manchester." Telephone: 8970 City (4 lines).

GLASGOW: 101, St. Vincent Street, C2.

Telegrams: "Hife, Glasgow." Telephone: Central 4867.

PUBLISHED WEEKLY.

Subscription Rates: Home, £1 1s. 8d.; Canada, £1 1s. 8d.; other countries abroad, £1 3s. 6d. per annum.

Entered as Second Class Matter at New York, N.Y.

As many of the circuits and apparatus described in these pages are covered by patents, readers are advised, before making use of them, to satisfy themselves that they would not be infringing patents.

## CONTENTS OF THIS ISSUE.

	PAGE
EDITORIAL VIEWS	1
S.G. SHORT WAVE.—III. BY H. B. DENT	2
TUNING CIRCUIT LOSSES. BY A. L. M. SOWERBY	9
VALVES WE HAVE TESTED. THE LISSEN RANGE	14
CURRENT TOPICS	16
AMERICAN BEAM STATIONS. BY M. RAY	18
WIRELESS THEORY SIMPLIFIED. PART XV. BY S. O. PEARSON	22
BROADCAST BREVITIES.	25
LETTERS TO THE EDITOR	26
NEW APPARATUS REVIEWED	28
READERS' PROBLEMS	29

## SHOULD THE DATE OF THE SHOW BE CHANGED?

THE New Year always suggests the opportunity for reviewing the events of the old year so as to endeavour to profit by the experience gained in the past and put it to good use during the year that is ahead. In wireless we are continually profiting by experience, for the science is a new one, and broadcasting, in particular, being relatively very new, there are few precedents to go upon to assist in guiding the policy of the broadcasting service and the industry which it has founded.

### Delay in Fulfilling Orders.

A reader whose letter is published in this issue comments on the date which has been chosen for the annual Radio Show, and whilst this subject has been discussed previously, our correspondent now puts forward some very good arguments as to why the date of the annual Show should be changed. Our readers and, in fact, all sections of the wireless community are painfully

aware that this year, as in previous years, manufacturers are in many instances far behind in executing orders which they have received for apparatus which was first exhibited at Olympia in September. Our correspondent points out that it is common knowledge that at the annual Motor Show at Olympia orders for new cars frequently cannot be fulfilled until the spring, but as, luckily, the spring is just the time when most people want to put new cars into commission, there is nothing very much the matter with this arrangement. With the wireless public, however, it is in the autumn that the public demand for wireless apparatus is at its height, and this demand continues throughout the winter months. If the Wireless Exhibition were to be held at a date which gave time for apparatus to be in full production by the autumn, then much would have been accomplished towards overcoming the present difficulties.

### When is Interest at its Height?

It has been argued that the Radio Exhibition should be held in the autumn because that is the time when public interest in broadcasting and indoor entertainment has been aroused, but we believe that the public interest is even greater towards the close of the winter months, when the value of wireless is fresh in their minds, than it is at the end of the summer months before their interest has been fully rekindled. We are aware that manufacturers cannot well be expected to make arrangements for a very large production of apparatus until they have some indication of the demand for that apparatus, and this is given as the reason why in many instances deliveries of apparatus exhibited at the September show are still far behind several months later. But by holding the Exhibition at the end of the winter the demand would tend to develop more gradually than at present and would help to ease the manufacturing problem. In addition, it is believed that this change would be to the advantage of exhibitors because it would tend to make radio sales less seasonal in character.

### A Matter for Urgent Consideration.

We are given to understand that arrangements for the annual Radio Show have to be made a year or two in advance, but if the reason for a change in date is sufficiently good, as we believe it is, then the question should be looked into now in order to see how quickly the change can be introduced. As matters stand at present, with each succeeding season the same complaints occur regarding delay in deliveries of apparatus, and there seems to be no obvious cure for the situation, except by shifting the date of the annual Show.

# S.G. Short Wave III

An Empire Set Embodying a  
Tuned H.F. Stage.

By H. B. DENT.

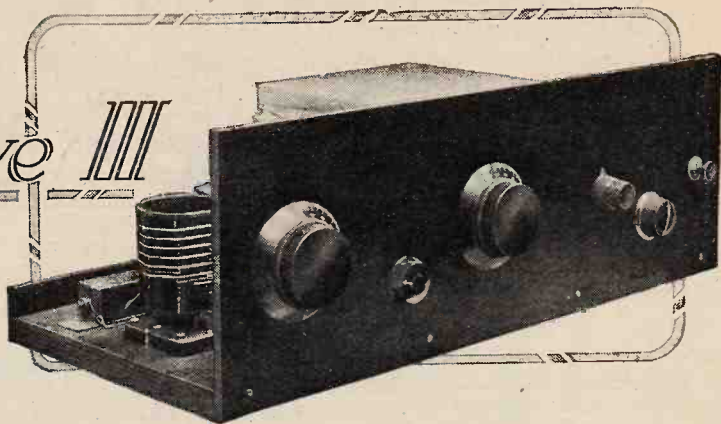

TO-DAY the number of short-wave broadcast stations operating a regular schedule is more than sufficient to afford a welcome recreation to listeners in this country. As regards the exile abroad, possibly separated by many thousands of miles from the home country, the only link is through the medium of the special programmes radiated from 5SW, the short-wave experimental station at Chelmsford.

The ubiquitous detector-L.F. arrangement has done yeoman service and for long has been regarded as the accepted standard for a short-wave set. So far there has been a decided reluctance on the part of designers to apply the principles of high-frequency amplification to short-wave reception, and possibly some justification existed in the past, as the general unsuitability of the average receiving valve was a serious obstacle. The question was discussed, however, at some length in an

article entitled "High-Frequency Amplification on Short Waves," which was published in *The Wireless World* as far back as October 12th, 1927. When it is realised that the frequencies dealt with are of the order of 15 million cycles per second, it will be appreciated that the problem is no mean one.

In view of the many improvements made recently in the design of valves—especially those developed particularly for high-frequency amplification—the present would appear opportune again to focus attention on this subject. The screen-grid valve, which has effected such a radical change in the design of H.F. amplifiers for broadcast reception, should prove equally efficacious on the ultra-short wavelengths.

In conformity with modern practice, neutralised circuits will be ruled out, since, on short wavelengths, the complications in the assembly of a suitable receiver would tend to place this beyond the reach of the average home constructor. Consideration will be given, therefore, only to the possible ways and means whereby a worth-while stage gain is possible of attainment by employing a relatively simple unneutralised H.F. amplifier.

This proviso unfortunately limits us in our choice of valve for the H.F. stage, because only those which show a very low internal anode-to-grid capacity will be at all suitable for this purpose. At the outset it might be stated that even with the best valve—regarded from this viewpoint—the amplification afforded on 20 metres could not possibly attain that at 200 metres. For example, the Mazda 215 S.G. valve shows a theoretical stage

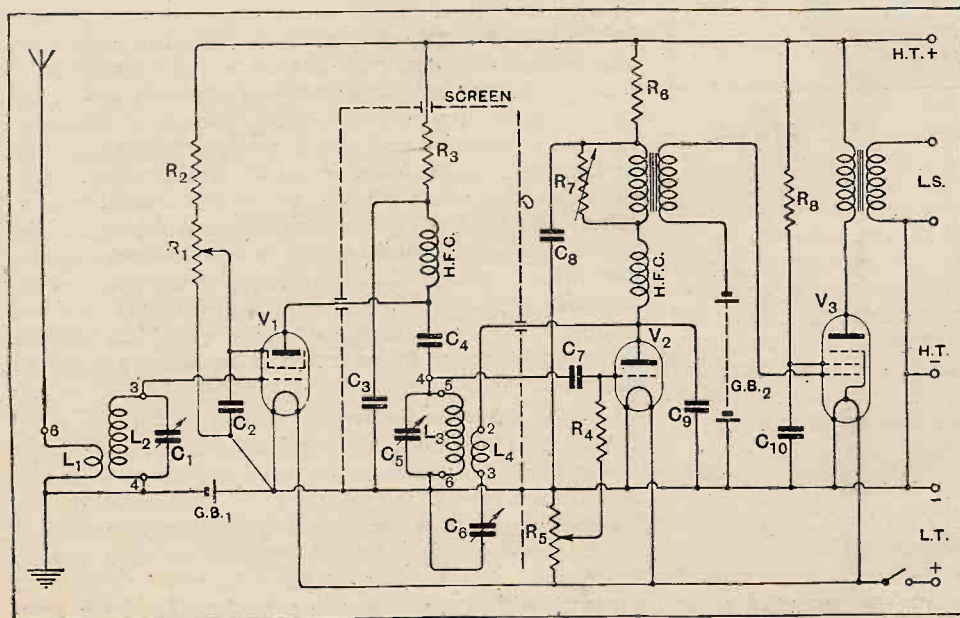

Fig. 1.—The theoretical circuit values are as follows:  $C_1$  and  $C_5 = 0.00015$  mfd.,  $C_2$  and  $C_3 = 0.01$  mfd.,  $C_4$  and  $C_6 = 0.0002$  mfd.,  $C_7 = 0.0001$  mfd.,  $C_8 = 0.000075$  mfd.,  $C_9 = 2$  mfd.,  $C_{10} = 1$  mfd.,  $R_1 = 30,000$  ohms,  $R_2, R_3$  and  $R_6 = 20,000$  ohms,  $R_4 = 5$  megohms,  $R_5 =$  Polar semi-fixed potentiometer,  $R_7 = 200,000$  ohms,  $R_8 = 5,000$  ohms.

**S.G. Short Wave III.—**

gain of about 150, unneutralised, at 200 metres, whereas at 20 metres the calculated stage gain, also unneutralised, is of the order of 60 only. We know that in practice the theoretical amplification is difficult of attainment. On 20 metres the incidental losses pile up in an alarming manner; how they accumulate is far too involved to be dealt with here. But in spite of this some preliminary tests showed that a useful gain is possible, and accordingly the design of the set described in this article was prepared.

As an indication of the importance of choosing a valve with the lowest possible anode-grid capacity, it may be mentioned that with one having an internal capacity of 0.05  $\mu\mu\text{f}$ —or ten times that of the particular example given above—the calculated stage amplification, unneutralised, would fall to 18. So that it is very doubtful if, under these conditions, any justification would exist for employing an H.F. stage.

**Single H.T. Feed.**

Ease of construction has been the guiding factor in designing the set and, so far as technical considerations will allow, only those parts readily obtainable have been used. With the exception of winding the coils, it resolves into a straightforward assembly job for which the tools found in the average amateur's workshop should suffice.

The theoretical circuit is shown in Fig. 1, and from this it will be seen that the receiver consists of a screen-grid H.F. stage followed by a leaky grid detector which is transformer-coupled to a pentode output valve. This choice assures the maximum overall amplification with the minimum number of valves. A single H.T. positive feed is favoured, as this discharges all sections of the H.T. battery at the same rate. Each stage is adequately

decoupled to counteract any tendency towards instability, the decoupling resistances acting also as voltage limiting devices where a lower potential than the maximum bat-

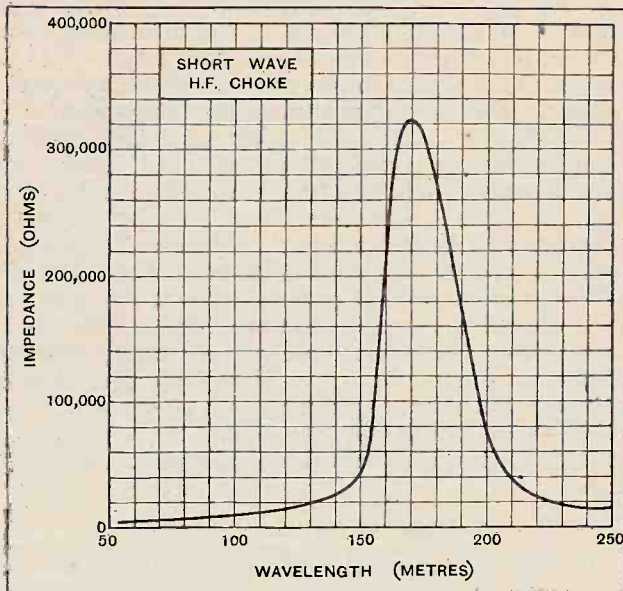
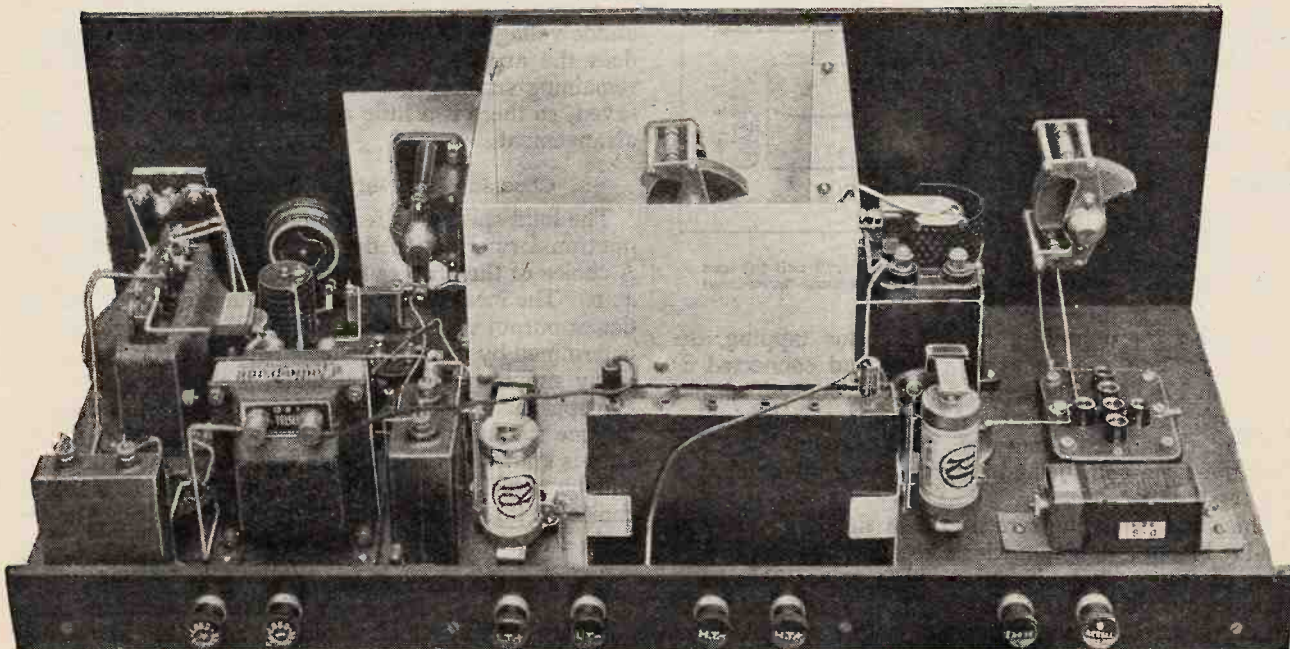

Fig. 2.—Impedance curve of a typical short-wave H.F. choke with a shunt capacity of 8  $\mu\mu\text{f}$ .

tery voltage is considered desirable. It should be pointed out that this policy slightly increases the initial cost, but not to any appreciable extent, because decoupling resistances would be required in any case, but their value has been raised in some instances to conform with the requirements of a single H.T. feed.

In designing the tuning coils it was decided to give preference to the parallel feed and tuned grid circuit, as the construction of H.F. transformers suitable for use on



Rear view of set with coils and valves removed.

**S.G. Short Wave III.—**

the wavelengths dealt with in this case would be rather involved. Incidentally, it may be mentioned that preliminary tests showed there was little to choose between these two tuning arrangements. From the illustrations it will be seen that the ordinary broadcast type of H.F. choke is incorporated in favour of one of the short-wave variety. This course was adopted after very careful consideration of the merits of both types. Readers will be familiar with the impedance curves of H.F. chokes, as these have been published from time to time in this journal. In Fig. 2 is reproduced a representative curve of a short-wave choke resonating at 170 metres when shunted with the capacity mentioned in the inscription. The difference in impedance at 50 metres and at 170 metres is most marked, and on still shorter wavelengths the broadcast variety shows an impedance very nearly equal to that of the short-wave type. Since there is so little to choose between the two preference was given to the larger choke, as this enables the usefulness of the receiver to be extended to cover the normal broadcast wavelengths with ease.

**Extension to Medium Waveband.**

To maintain a reasonable degree of selectivity the leaky grid detector should be connected across a portion only of the H.F. coil when using the set on the normal broadcast band, but there is nothing gained by adopting this course on short waves. The connections to the coil base are planned accordingly, the required interconnection between the sockets being made on the coil former. Selectivity can be further improved on the 250-500-metre band by arranging the H.F. coil as an auto-transformer. Ultimately a compromise was made between the best

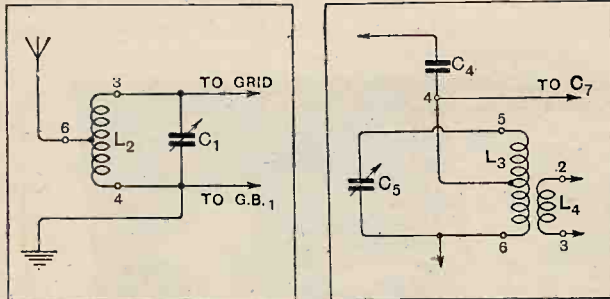

Fig. 3.—Theoretical connections of the aerial grid coil (a) and tuned grid H.F. coil (b) for use on the medium broadcast waveband.

transformer ratio and optimum detector tapping; the H.F. coil being tapped at its centre and connected as shown in Fig. 3. The aerial-grid coil connections also are given in this diagram. A separate aerial winding was not considered necessary, a tapping, a few turns from the earth end, being brought out for attachment of the aerial lead.

The voltage for the screen-grid in the H.F. valve is obtained from a potentiometer consisting of a fixed resistance of 20,000 ohms, in series with a 30,000-ohm wire-wound potentiometer. Assuming that a 150-volt H.T. battery is used, the screen voltage will be variable from 0 to 90 volts approximately. The fixed resistance sets a

limit to the maximum potential available, and assures that the valve will not be overrun. The remainder of the circuit calls for little further comment, as it is perfectly straightforward. Mention might be made, however, of the 5,000 ohms resistance in the auxiliary grid lead of the pentode valve. It has a dual function. It serves to decouple this circuit, counteracting any tendency towards L.F. instability due to battery resistance, and secondly, it limits the voltage on the grid. Without the resistance the potential on the auxiliary grid would be higher than that on the anode, due to the voltage dropped across the primary of the output transformer.

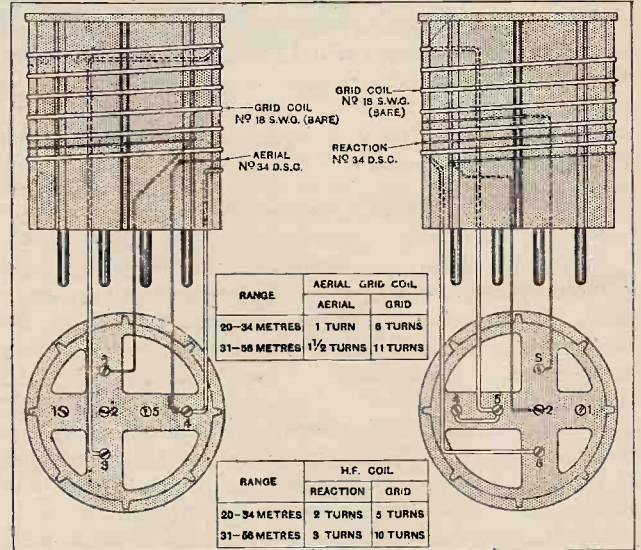

Fig. 4.—Detailed drawing of the coils giving winding data for the 20-34 metre and 32-56 metre wavebands. On the left is the aerial-grid coil, the other being the H.F. coil.

The writer has found that pentode valves function just as well with an auxiliary grid potential slightly less than the anode voltage. The A.C. resistance rises slightly, but so does the amplification factor, the mutual conductance remaining sensibly the same. A few milliamps can be saved, so there is a little compensation for adopting this arrangement.

**Choosing the Output Transformer Ratio.**

The loud speaker is fed through a Pye step-down output transformer designed especially for use with pentodes. A choice of three ratios is available, viz., 2 : 1, 3 : 1 and 4 : 1. The most suitable ratio, having regard to the particular output valve and loud speaker used, might well be determined by trial and error. Alternatively, it is a relatively simple matter to calculate, if the valve resistance and speaker impedance are known. This will be correct for one frequency only, but if the loud speaker impedance is known at mean speech frequency, the ratio found will be sufficiently accurate for our purpose, since the choice of three alternatives only is available. The formula is:—

$$\text{Transformer ratio} = \sqrt{\frac{\text{Valve A.C. resistance}}{\text{Speaker impedance}}}$$

Before passing on it would be advisable to mention that one side of the secondary coil on the output trans-

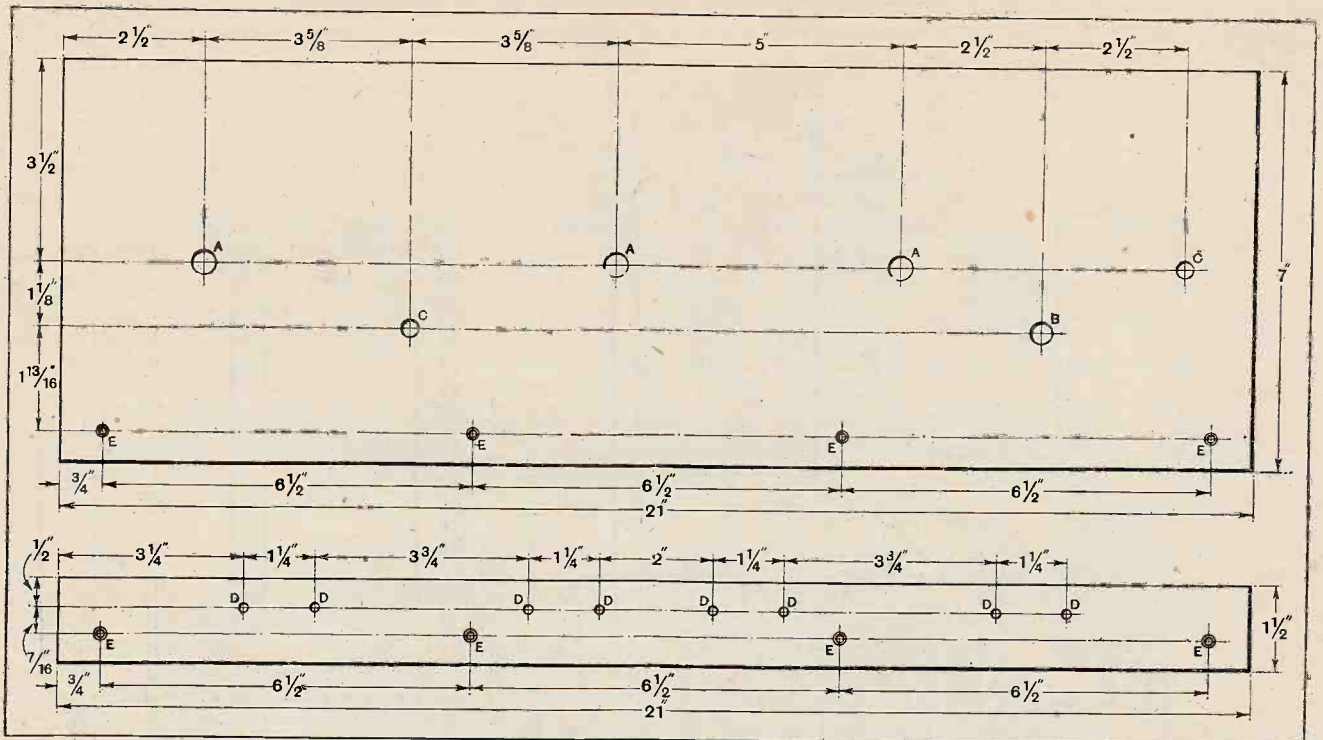

Fig. 5.—Dimensional data of panel and terminal strip. Sizes of holes are as follows: A = 7/16in. dia., B = 3/8in. dia., C = 5/16in. dia., D = 5/32in. dia., E = 1/8in. dia., countersunk for No. 4 wood screws.

former should be tied down to the filament circuit. Unless this connection is made, trouble might be experienced from an occasional L.F. howl. There are other means of curing it, but that suggested is quite satisfactory. Experiment will determine the "live" terminal, and this should be "earthed."

The process of assembly will be found a relatively simple matter, as all parts are readily accessible. The screening box, which is supplied unassembled, can be put together in a few minutes. When putting this box together it will be necessary to use countersunk screws, in place of the round head variety supplied, for fixing the

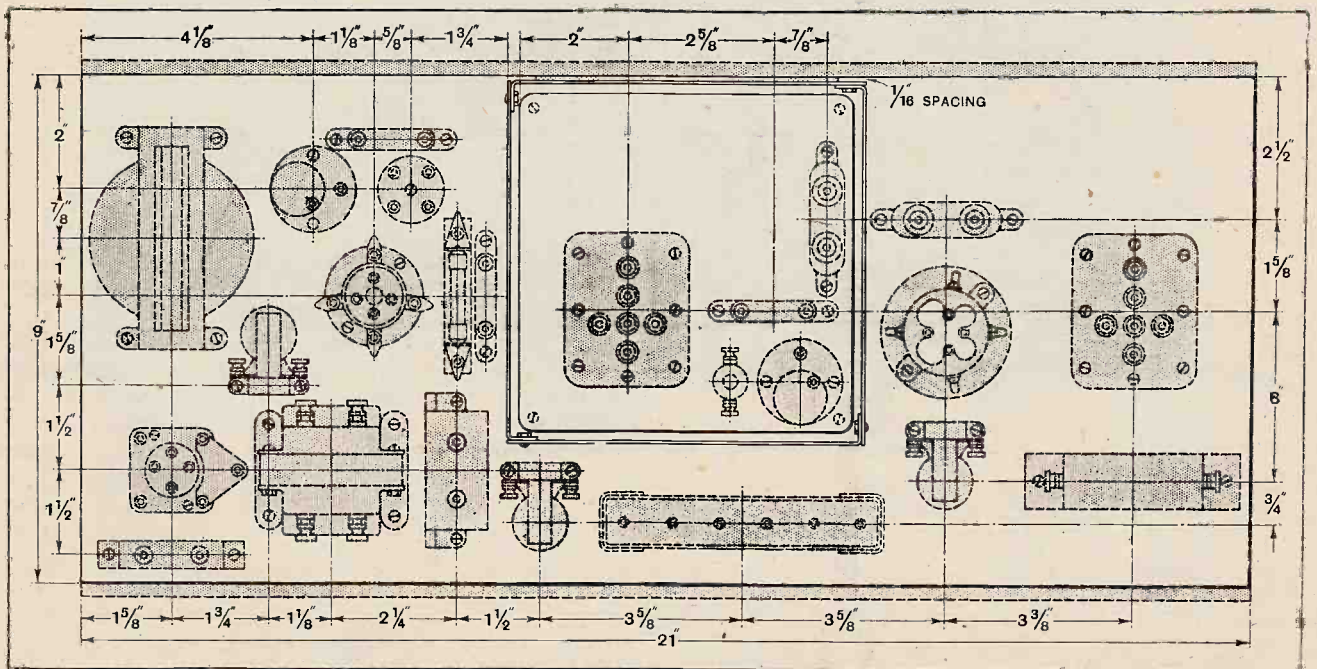

Fig. 6.—Disposition of the components on the baseboard.

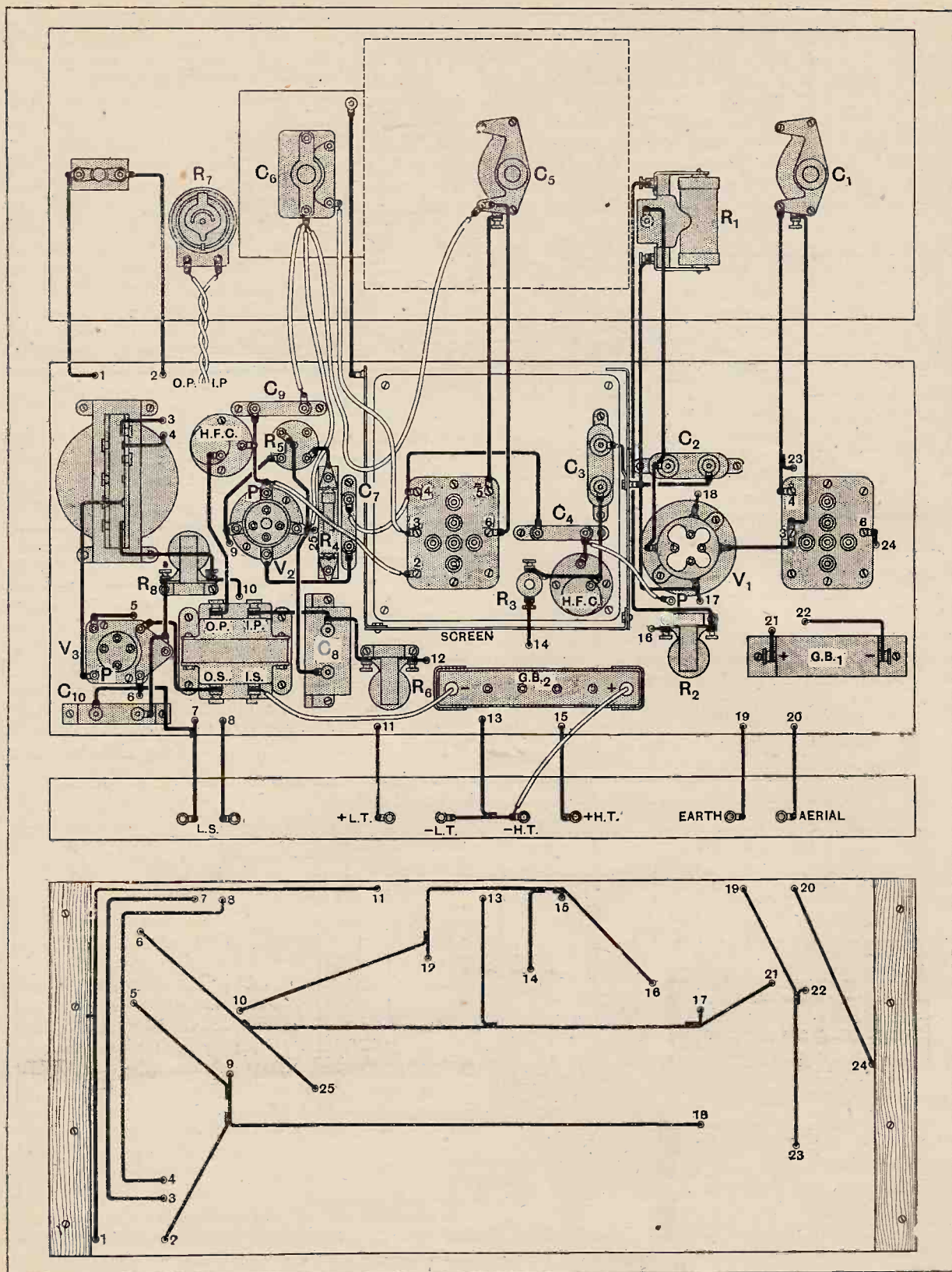

Fig. 7.—Practical wiring plan. Wires passing through the baseboard are lettered to facilitate tracing their path as shown on the under-deck plan.



LIST OF PARTS.

- 2 Variable condensers, 0.00015 mfd., with vernier and dial (Polar Q.J.).
- 1 Reaction condenser, 0.000075 mfd., with vernier (Polar Capcon).
- 2 Fixed condensers, 0.0002 mfd. (T.C.C.).
- 1 Fixed condenser, 0.0001 mfd. (T.C.C.).
- 1 Fixed condenser, 1 mfd., 400 volt D.C. Test (T.C.C.).
- 1 Fixed condenser, 2 mfd., 400 volt D.C. Test (T.C.C.).
- 2 Fixed condensers, 0.01 mfd. mica (Dubilier B. 775).
- 2 H.F. chokes (Wearite H.F.O.).
- 1 Decoupling resistance, 600 ohms. (Wearite).
- 2 Anode resistances, 20,000 ohms, and holders (R.I.).
- 1 Anode resistances, 5,000 ohms, and holders (R.I.).
- 1 Fixed potentiometer (Polar).
- 1 Power potentiometer, 30,000 ohms (Varley).
- 1 Valve holder (Aermonic "D").
- 1 Valve holder (Aermonic "H").
- 1 Valve holder (Whiteline Pentode).
- 1 L.F. transformer, 3-1 (Telsen Radiogrand).
- 1 Output transformer (Pye 657/P).

- 1 Variable resistance, 0-200,000 ohms (Electrad Royalty "J." Rothermel).
- 1 Grid leak, 5 megohms (Ediswan).
- 1 Holder for above (Wearite).
- 1 On-off switch (Pioneer).
- 1 Aluminium screening box (Bowyer Lowe).
- 4 Coil formers (Colvern Standard 6-Pin).
- 2 6-Pin bases with terminals for above (Colvern).
- 1 9-Volt Grid bias battery (Siemens).
- 1 Pair Grid bias clips for above (Bulgin).
- 1 Grid cell, 0.9 volts (Siemens).
- 8 Terminals (Burton).
- 1 Ebonite panel, 21 x 7 x 3/16 in.
- 1 Ebonite terminal strip, 21 x 1 1/2 x 3/16 in.
- 1 Baseboard, 21 x 9 x 1/4 in.
- 2 Wander plugs (Clax).
- 2 Dial indicators (Bulgin).

Quantity No. 18 S.W.G. tinned copper wire, Systoflex, screws, etc.

Approximate cost of parts, £9 2s. 6d.

In the "List of Parts" included in the descriptions of *THE WIRELESS WORLD* receivers are detailed the components actually used by the designer, and illustrated in the photographs of the instrument. Where the designer considers it necessary that particular components should be used in preference to others, these components are mentioned in the article itself. In all other cases the constructor can use his discretion as to the choice of components, provided they are of equal quality to those listed and that he takes into consideration in the dimensions and layout of the set any variations in the size of alternative components he may use.

front section to the side pieces, and the base piece. Four screws 1/4 in. long will be required. The size is No. 4 B.A., with nuts to match. This is deemed necessary in view of the small clearance allowed on the condenser fixing bushes. They have been designed to accommodate panel thicknesses up to 1/4 in., and it will be very difficult to fit them unless the box is brought as close as possible to the back of the panel. If the screw heads

be required. This may be cut from a piece of hard wood, such as mahogany, or even pitch pine would answer if it can be obtained more readily. In the model illustrated five-ply wood was used. Two battens, each 9 in. x 1 in. x 3/8 in., are now required, one to be screwed on to each end of the baseboard, on the under side. A shallow well is thus formed, in which much of the wiring can be accommodated. A terminal strip, the full length of the base,

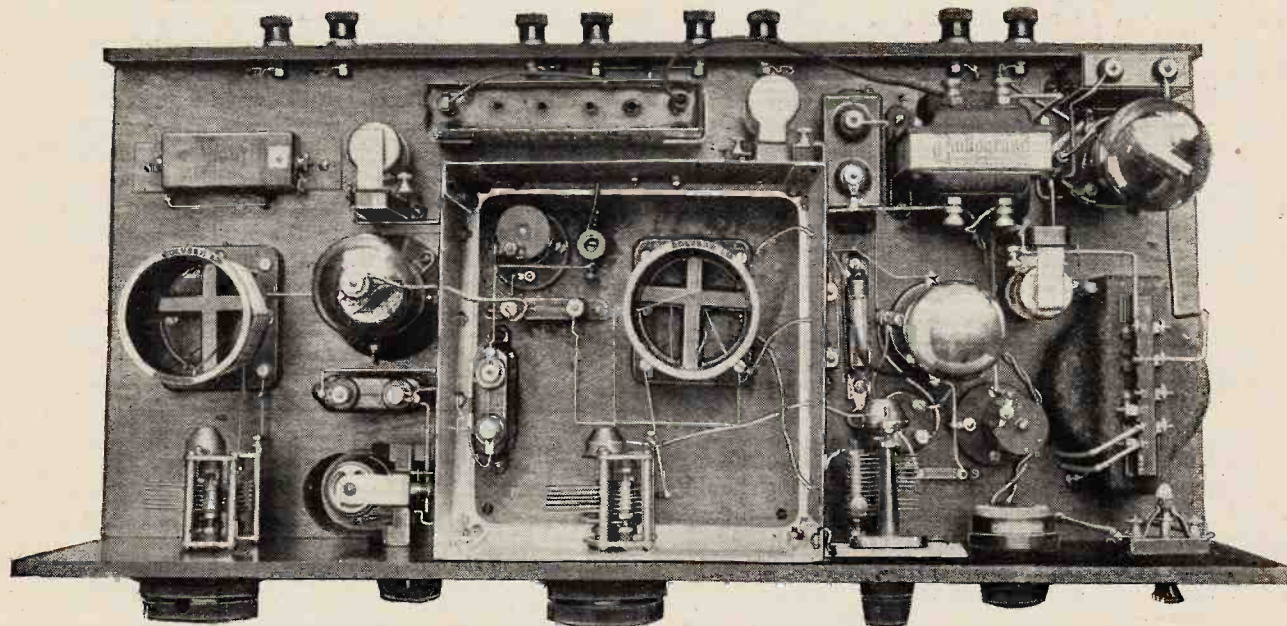

Plan view of receiver showing the straightforward layout of the H.F. stage.

are not countersunk into the metal they will separate the box just sufficiently from the panel to leave space for fitting the lid. In addition, a small washer—cardboard of suitable thickness will answer—should be slipped over the fixing bush between the box and the panel. A loose interior baseboard is included with the box, thus relieving the constructor of the onus of preparing this. A baseboard, 21 in. long, 9 in. wide, and 3/8 in. in thickness, will

and a panel 21 in. x 7 in. x 3/16 in., completes the framework on which the set is assembled.

Having marked out and drilled the panel in accordance with the details given, it can be fixed to the base and the position of the hole in the screening box, through which the H.F. condenser bush is passed, may be marked. Before assembling the components, unship the panel and screening box. The parts on the panel can

**S.G. Short Wave III.—**

then be assembled with the exception of the H.F. tuning condenser and the reaction condenser. It is advisable to leave the box off until most of the wiring has been done. This applies particularly to the connections on the panel potentiometer and other components in close juxtaposition to the metal container.

The H.F. tuning condenser cannot be fitted until the small sub-base is ready to be dropped into its box. As regards the reaction condenser, and its small screening plate, fitting this too early will interfere with wiring the various small components on the baseboard immediately below it.

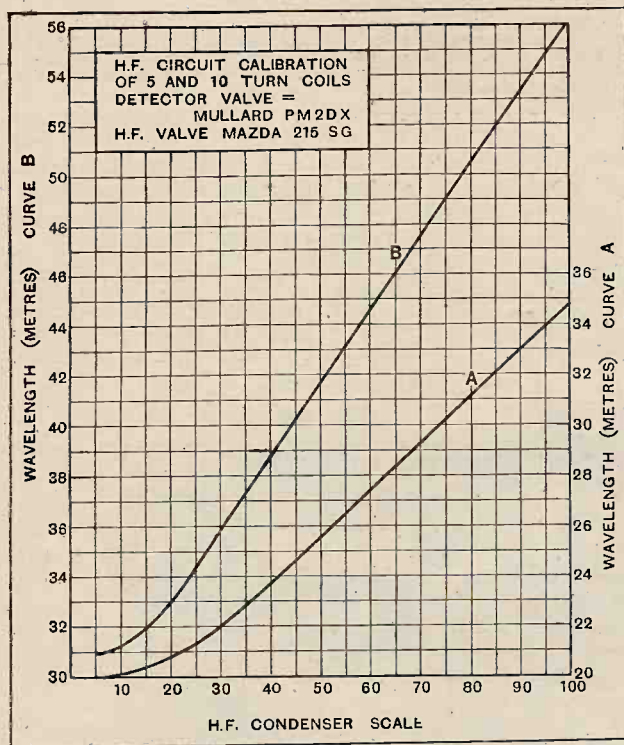

Fig. 8.—Calibration curves of the H.F. coil with reaction adjusted to cause the stage to oscillate weakly.

Apart from the above-mentioned order of procedure, there is no particular sequence in which the wiring should be done. It is well to check occasionally with the theory diagram and mark off each lead as it is completed.

Particulars of the coils, so far prepared, are given in the diagrams. Two are required for each waveband. It has been found that for the 20- to 34.9-metre range, five turns of No. 18 S.W.G. tinned copper wire, spaced  $\frac{1}{4}$  in., are required for the H.F. coil, but to cover the same waveband six turns must be used on the aerial-grid coil. Incidentally, the aerial winding is separate, and consists of one turn of fine gauge wire, wound in the space between the first and second turns from the earth end of the grid coil. In all cases the direction of the windings is the same.

The two other coils shown cover a waveband of from 30.9 metres to 56.3 metres, and 10 turns of No. 18

S.W.G. tinned copper wire are used for the H.F. coil. The aerial-grid coil for this range has 11 turns of the same gauge wire. Each turn is spaced  $\frac{3}{16}$  in. from its neighbour. The aerial winding consists of  $1\frac{1}{2}$  turns in this case. It is hoped that shortly details of the coils required to extend the usefulness of the set to about 150 metres will be available for publication, also the winding data for a set of medium-wave broadcast coils.

**Valves.**

A calibration curve for each of the H.F. coils described here has been prepared. These may require a slight modification in some cases, as the calibration was made with the receiver just oscillating. Any change in the capacity of the reaction condenser will shift the tuning slightly. The curves will be a useful guide in the beginning, as, provided the same type of valve as mentioned on the chart is used in the H.F. and detector stages, tuning will be sufficiently accurate to identify most of the principal transmissions coming within the range of these coils.

With the exception of the H.F. stage, where unfortunately not much latitude can be given, any well-known make of valve may be used. In the case of the detector, best results will follow the employment of a valve not exceeding about 12,000 ohms A.C. resistance. The Cossor 210 L.F., Mullard P.M.2 D.X., the Mazda L.210 and the Marconi and Osram L.210 are good examples of the type most suited for use in this position. In the output stage a pentode is required, and since an output transformer with a choice of ratios is fitted, any pentode, provided it has the same filament voltage rating as the other valves chosen, can be used with confidence.

The writer recommends the Mazda 215 S.G. for the H.F. stage by virtue of its exceedingly low anode-grid capacity. But as there is a little delay in obtaining deliveries of this particular make at the present moment, excellent substitutes would be the Mullard P.M.12, Six-Sixty S.S.215 S.G., and the Marconi or Osram S.215, to mention a few only in the two-volt class.

*This receiver is available for inspection by readers at the Editorial Offices, 116-117, Fleet Street, London, E.C.4.*

**BOOKS RECEIVED.**

*Photograms of the Year.* Edited by F. J. Mortimer, F.R.P.S., the Editor of *The Amateur Photographer and Cinematographer*. About 100 reproductions of fine pictures made with the camera by the leading photographers in all countries where the camera is used. For the amateur photographer and those who are interested in picture-making, it provides guidance and inspiration that gives it an undoubted educational value. Published by Iliffe and Sons Ltd., London. Price 5s. net in stiff paper covers, or 7s. 6d. net in cloth boards.

o o o o

*Electricity: What It Is and How It Acts* (Vol. I), by A. W. Kramer, A.M.A.I.E.E.—A simple treatise on the part played by the electron in ordinary electrical phenomena, including its action in diode and triode valves. Pp. 274+xiii with 130 diagrams and illustrations. Published by Technical Publishing Company, Chicago, U.S.A. Price \$2 net.

# TUNING CIRCUIT LOSSES

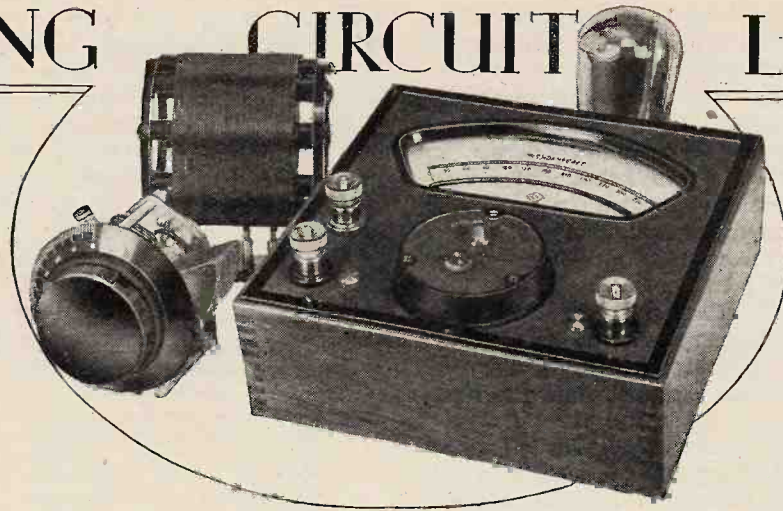

## Sources of Incidental Dielectric Loss.

By A. L. M. SOWERBY, M.Sc.

THERE is no component in the whole of a high-frequency amplifier that has received so much attention as the tuning coil, for it was early recognised that the signal strength given by a receiver could be considerably enhanced by using coils of low high-frequency resistance. The classical researches on the subject by S. Butterworth<sup>1</sup> brought to light the fact that, for the frequencies used in the broadcast wave-band, any coil of reasonable dimensions must be wound with stranded wire, or Litzendraht, if the lowest possible resistance, and hence the greatest amplification, was required. This information was promptly acted upon by *The Wireless World*, and complete receivers in which the tuning coils were wound with "Litz" were described and proved, as might be expected, appreciably in advance of receivers employing coils of less scientific design. The use of coils wound with Litz has now become usual in all sets in which the maximum amplification at high-frequency is desired.

Butterworth's researches into the resistance of coils were carried out on a purely mathematical basis, and had for their object the determination of the resistance due to the copper wire of which the coil is wound, without attempting to make any allowance for the extraneous losses due to the former and the plug or other mount used. Nor were they at any time intended to cover losses originating outside the coil itself in the tuning condenser and the various components which, in a finished set, are connected in parallel with the tuned circuit. It is known, however, that losses arising from such sources as these, and which consist mainly of dielectric losses, form a very considerable proportion indeed of the total losses in a tuned circuit, so that the formulæ developed by Butterworth, while they are an absolutely indispensable aid in designing a coil, yet give us no reliable estimate of the total resistance of the tuned circuit as it exists in a practical receiver.

The problem that lies before the designer of a receiver, then, is to find some approximation to the resistance of the tuned circuit as a whole, for it is this that he has to take as the basis of his design. The contribution to the total resistance made by the copper wire of the coil can fairly readily be calculated from Butterworth's formulæ, while at the cost of a little further calculation one can arrive at a coil so designed that it is physically impossible to improve upon it without increasing its dimensions. Unfortunately, that part of the total resistance which arises from the imperfections of the various insulating materials which have inevitably to be connected to the tuned circuit cannot be calculated at all. For any one case, of course, the value of the losses arising in the various dielectrics can be measured, but a systematic treatment does not appear to be possible.

### Copper and Dielectric Losses Compared.

The sources of dielectric loss in a finished receiver are many and various. First, there is the insulation on the wire itself, and the former on which the coil is wound. If the coil is made interchangeable with others so that different wave-bands can be covered, there are losses also, and usually very considerable losses, in the plug-fitting of the coil and in the holder into which it fits. Then the tuning condenser contributes its share, for the fixed plates must be carried on a support of some insulating material, so that losses enter here also. Before any use can be made of the tuned circuit it must be connected across grid and filament of a valve, so that the insulating material both of the holder and of the base of the valve itself have an opportunity of absorbing energy.

Each of these sources of loss, if sufficient care is taken, can be made quite small; the sum-total of them all is always far larger than one would like, even when every possible precaution has been taken. As a result, the high-frequency resistance of the tuned circuit must inevitably be very much higher than the figure derived from applying Butterworth's formulæ to the coil itself.

<sup>1</sup> *Experimental Wireless*, April, May, July, and August, 1926.

**Tuning Circuit Losses.—**

The additional losses have still further depressed the dynamic resistance of the coil, and it will be particularly noticed that with this set of components in parallel with the tuned circuit the dynamic resistance is, for the first time, lower at 200 metres than at 550. The one comforting thought, in face of the heavy loss in amplification that the augmented dielectric losses have brought about, is that the dynamic resistance of the tuned circuit is now practically constant, especially with the Litz coil, over the range 250 to 500 metres, which makes for easier receiver design and uniform amplification.

**A Bad Case.**

The curve of Fig. 4 represents, as has been pointed out, a case in which the dielectric losses have been reduced, by careful choice of components, to a value very considerably below that which obtains in the average receiver, though it is reasonably representative of the receivers described in the pages of this journal. In many sets, and in commercial sets in particular, dielectric losses appear to be relied upon to ensure stability in the high-frequency stages in face of considerable laxity in screening and decoupling. To check the magnitude of the dielectric losses in a case where no attempt has been made to minimise them, a series of measurements was made on a 2-inch diameter coil of the type which is made up, complete with primary, neutralising, and reaction windings, as a single unit.

The coil was a standard type with pin connectors, intended to be plugged into a coil base, and was made by a well-known firm. It bore the inscription "Split-primary H.F. Transformer," and was intended to cover the wave-band from 250 to 550 metres. The winding was 90 turns of 30 D.S.C., giving an inductance of 252 microhenrys.

The copper losses were first calculated; the corresponding dynamic resistances are given in the second column of Table IV. It was noticed that the wrong gauge of wire had been chosen for the coil; for minimum resistance it should have been wound with No. 26 instead of No. 30 gauge.

Measurement of the dynamic resistance of a tuned cir-

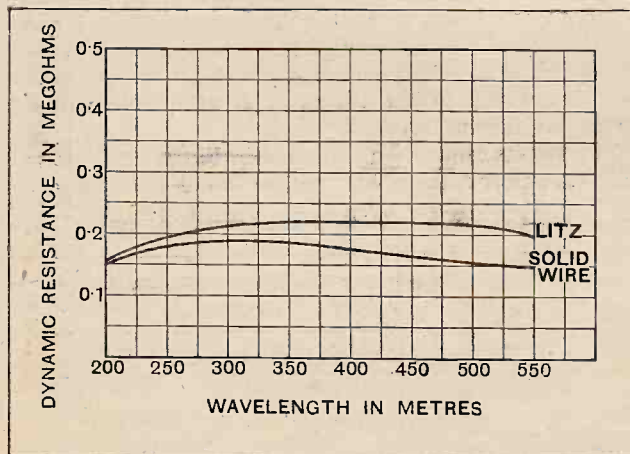

Fig. 4.—Dynamic resistance of tuned circuit with valve and valve-holder in parallel.

cuit incorporating, besides the coil, the multi-pin base for which it was designed, and with an H.610 valve in a bakelite holder, and a 3-megohm leak in clips mounted on bakelite connected in parallel, gave the results of the last column of Table IV.

TABLE IV.

Wavelength. (Metres.)	Dynamic Resistance. (Megohms.)	
	Copper Losses Only.	Complete Tuned Circuit as Described.
225	0.543	—
250	0.461	0.0225
300	0.352	0.0368
350	0.279	0.0436
400	0.228	0.0485
500	0.162	0.0502
600	0.122	0.0486

The numerical results of this table are plotted as curves on the same scale as preceding figures in Fig. 5.

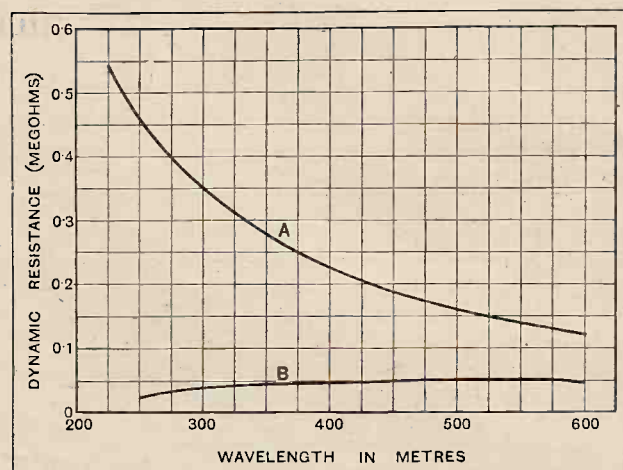

Fig. 5.—Losses in a commercial multi-pin plug-in coil of 2ins. diameter. Curve A shows the dynamic resistance calculated for copper losses only. Curve B gives the dynamic resistance as found in a practical circuit with dielectric losses. At 300 metres the dynamic resistance of this coil and circuit is about five times less than that of a 3in. *Wireless World* Litz coil.

from which can clearly be seen the appalling effect of unchecked dielectric losses on the efficiency of a tuned circuit. Nor must it be thought that the case chosen for measurement is in any way exceptional; on the contrary, it is typical of a very large class of sets. Dozens of receivers, embodying tuned circuits exactly like that examined, have been designed, and they are used in enormous numbers by those who are sufficiently unversed in technical matters to be unaware of the enormous loss in signal strength that the use of such tuned circuits necessarily involves.

The moral of all these measurements should by now be clear enough; it is that time and energy spent on determining the best winding for a coil are quite wasted unless a good deal of care is also devoted to keeping down the losses due to faulty dielectrics. If this point is overlooked, copper losses may be reduced to an almost negligible fraction of the total losses, being swamped out by the effects of dielectric absorption. In particular, it is interesting to enquire how far the use of Litz is justified in the average receiver.

**Tuning Circuit Losses.—**

There is, for example, no advantage whatever to be had from the use of stranded wire if the dielectric losses are to be on the scale found for the "multi-pin" coil and its appurtenances, for in such a case the copper losses form so small a proportion of the total losses that even if they are doubled or halved the efficiency of the tuned circuit as a whole would hardly be affected. At the other extreme, where dielectric losses are cut down to the minimum by decapping the valve, the substitution of solid wire for Litz would make a very large difference indeed to the behaviour of a receiver.

In the case where the valve is not decapped, but all components are picked carefully with an eye to reducing dielectric losses as far as convenience permits, we are not far from the borderline between the two extremes.

Where there is but one tuned circuit in the receiver the replacement of a Litz coil by a competently designed coil of solid wire would probably not be very noticeable. Since, however, the slight, but appreciable, gain that can be had from using Litz is cumulative from coil to coil, a receiver with two tuned circuits, and, still more, one with three, would show quite a marked falling-off in performance if solid wire were used in its place. Since, in addition, doubling the input to the detector valve results in something like a fourfold increase in rectified signal voltage, even quite small changes in efficiency on the high-frequency side of the receiver are still further magnified by the detector.

But as these points apply equally to dielectric losses, they do but emphasise the need for paying the very closest attention to this insidious thief of signal strength.

**PCJ's BIOGRAPHY.**

**Short Waves and Long Distances.**

THE history of wireless enterprise teems with achievements which really deserve that over-worked epithet "remarkable." And no list of such achievements would be complete which did not include the exploits of PCJ, the Philips short-wave station at Eindhoven. The story of how, on a morning in March, 1927, PCJ woke (if it had ever slept) to find itself famous, is told in a handsomely prepared booklet now issued by Messrs. Philips Radio. In 28 pages, brightened by numerous illustrations, the author gives not only the story of PCJ's rise to fame, but many interesting observations on short-wave work in general.

Among the illustrations is a reproduction of a *Wireless World* cartoon, which appeared in June, 1927, and caused some heart-searching among British wireless authorities. The cartoonist drew a parallel between the victory of the Dutch Admiral Van Tromp over the British Fleet in 1652, and the triumph of the Dutch wireless station in the ether waves. Tied to the mast-head of the Dutch ship was Van Tromp's legendary broom with which he "swept the seas," while a broom of more modern design was shown attached to the aerial at Eindhoven.

That PCJ's claim of a

world-wide audience is not an idle boast is seen by reference to the world map included in the booklet, showing the places from which reports have been received. Only Greenland and Siberia appear to have missed the call. Up to the present time twenty different languages have been spoken before the PCJ microphone. This alone must constitute a record.

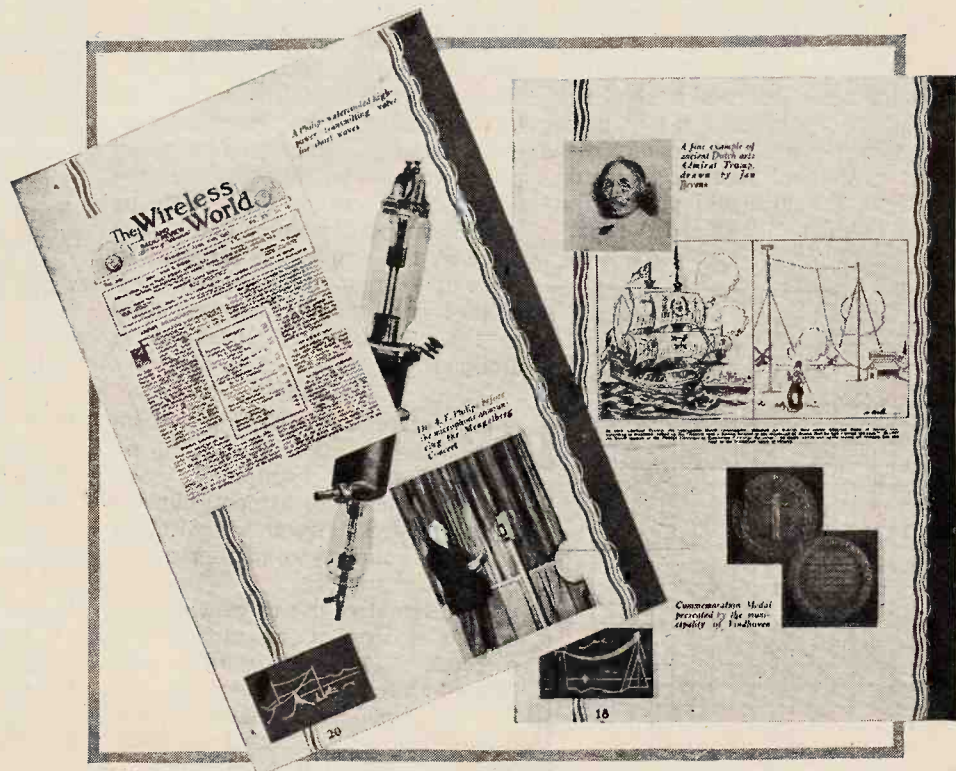

**HOLLAND'S SHORT-WAVE ENTERPRISE.** Messrs. Philips Radio have produced an attractive booklet giving the life story of PCJ the famous short-wave station at Eindhoven. The two pages illustrated, which are taken from the booklet, contain reproductions from "The Wireless World," one being an article of congratulation and the other our artist's cartoon on the subject.



## Events of the Week in Brief Review.

### THE BIG QUESTION.

In the next census of the United States, to be taken this year, householders will be asked whether they possess wireless sets.

### WIRELESS AT SCHOOLBOYS' EXHIBITION.

Electric and wireless displays are among the attractions of the Schoolboys' Exhibition now in full swing at the Horticultural Hall, Westminster. The Exhibition, which is organised by the *Daily Mail*, is open daily from 10 a.m. to 9 p.m. The closing date is January 8th.

### MORE SHORT WAVES FROM HOLLAND.

The Dutch Government short-wave plant at Kootwijk will soon be augmented by the addition of three new transmitters equipped for C.W. and radio telephony, which are now under construction. These will use the call signs PCO, PCS, and PDM. Their wavelengths will be 15.686, 16.60, and 16.182 metres respectively.

### BRITISH RADIO PUBLICITY IN FRANCE.

A number of British firms are now securing broadcast publicity via the French stations. *Radio Paris* devotes "hours" to Decca, Pathé, and Vocalion

records, and also provides programmes sponsored by the Revelation Suitcase Company and other British concerns. *Radio Toulouse* is a mouthpiece for Kolster Brandes, Ltd.

### MUSIC AT BREAKFAST.

A correspondent draws attention to the morning broadcasts from Huizen (1,875 metres). These take place on Mondays, Wednesdays, and Thursdays, beginning at 7.55, and consist of over an hour's recital of H.M.V. records.

### SURREY'S LOUD SPEAKERS.

Surrey County Council are seeking the views of local authorities as to whether steps should be taken to reduce public annoyance caused by loud speakers.

### VALVE MANUFACTURE DEMONSTRATION.

Working demonstrations of the process of valve manufacture will be a feature of the M.O. Valve Co.'s display at the Exhibition of the Physical and Optical Societies, to be held on January 7th, 8th and 9th at the Imperial College of Science, Imperial Institute Road, South Kensington. The valve demonstrations will include automatic grid making and technical displays designed to show the comparative power outputs of valves.

**NEARLY ANOTHER MILLION.**  
Receiving licences issued up to November 30th last numbered 2,914,521.

### WIRELESS AT THE B.I.F.

Over twenty firms have already booked space in the wireless section of the British Industries Fair, to be held in the new and reconstructed Olympia from February 17th to 28th next.

### ISSUING A WIRELESS LICENCE.

In reply to a recent question in the House of Commons the Postmaster-General, Mr. Lees-Smith, stated that the average cost of issuing wireless licences during the last financial year was 1s. 1d. per licence. This cost was based upon the time occupied, and it included provision not only for the issuing, recording and renewing of annual licences, but also for headquarters work and for such duties as the detection of unlicensed stations and any subsequent legal proceedings.

### THIS ETHERIAL MAGIC.

Alarming remarks are made by a writer in a Chatham newspaper. "Isn't this wireless craze going too far?" he asks. "With a great many people nowadays it would appear that there is but one thing they live for—wireless. It appeals to

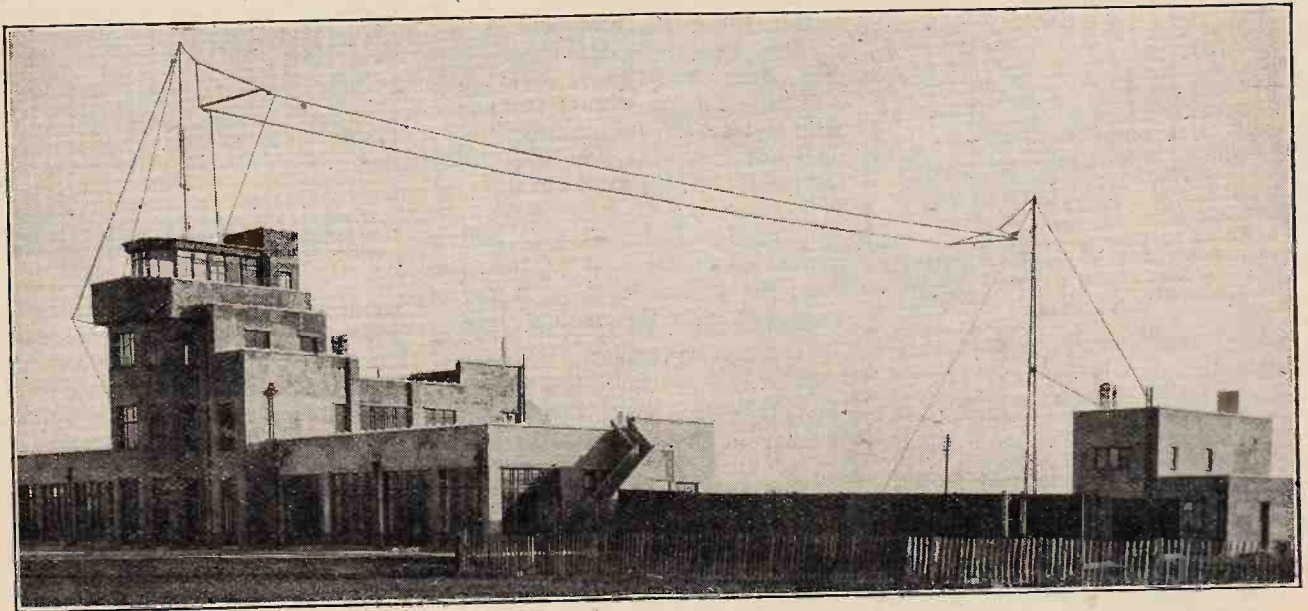

**FLYING LESSONS BY WIRELESS.**—A general view of the recently erected aerial tuition tower at Heston aerodrome. From his vantage point above the transmitter room the instructor can observe the evolutions of his pupils and give advice when it is most needed.

them as a new toy does to a child; they cannot find out too much about it. But uninitiated in the most elementary things of this ethereal magic, they indiscreetly seek to investigate its intricacies, regardless of the results of their folly. The wireless set owner is legion, and it is not more popular than with the poorer people. . . . A working class man entered a wireless shop and purchased a valve costing half a guinea. He was accompanied by his barefooted child!"

Well, what are we going to do about it?

o o o o

**A GEOGRAPHICAL ERROR.**

By an unaccountable error we suggested that the Bucharest broadcasting station, illustrated in our issue of December 4th, exists for the delectation of *Hungarian* listeners. The Bucharest station is, of course, Roumanian, and is owned and operated by the Societatea de Difuziune Radiotelefonica din Romania. The power is 12 kW. and the wavelength 394 metres. We apologise for the mistake.

o o o o

**LICENCEES CALL THE TUNE.**

Renewal application forms for broadcast licences in Denmark are accompanied by a voting paper on which the Post Office requests listeners to express their views on the programmes. Apparently Danish programmes have points in common with those of other countries, a year's voting having shown that listeners are "dissatisfied."

o o o o

**A NEW APPOINTMENT.**

Mr. Bernard C. Holding, for the past three years editor of *The Electrician*, with which journal he has been associated since 1923, has resigned the editorship to take up an appointment with the International Standard Electric Corporation, London, on January 1st.

o o o o

**WIRELESS OPERATORS DISSATISFIED.**

General dissatisfaction with the wages and condition of marine wireless operators has led the Association of Wireless and Cable Telegraphists to apply for a conference with employers. The Association states that the 1926 award of the Industrial Court has been given loyal and patient trial, but that it is now considered that the award was and is a miscarriage of justice to Association members. Objection is taken to the method of fixing pay according to the tonnage of the ship, and the standard of wages is also condemned.

o o o o

**G.W.R.'S RADIO BEACON.**

The construction of a wireless beacon to assist the navigation of the Transatlantic liners and other shipping in Plymouth Sound during fog is being considered by the Great Western Railway Co. They contemplate erecting the station at Penlee Point, at the western end of Plymouth Sound, and, as owners of the docks at Plymouth, are prepared to bear the cost of building and equipping the station and necessary apparatus. The cost of maintenance, however, is the difficulty which is holding up the scheme. The company are understood to insist

that after providing the station they should not be expected to undertake an annual expenditure of £600 to £1,000. Negotiations are in progress which it is hoped will settle the question of maintenance, but should they fail the station may not be erected.



A GERMAN "HAM" STATION.—D4CM, one of the most active amateur stations in Berlin. An input of 28 watts is used. The transmitter, seen on the left, employs the Hartley circuit.

**TELEPHONES ON ATLANTIC LINERS.**

Interesting technical details are now available regarding the new ship-to-shore telephony service inaugurated on the United States liner *Leviathan*.

The two parts of a conversation between the *Leviathan* and a land telephone are, as far as the radio link is concerned, carried by two separate radio waves of different wavelength. The radio wave from land to ship is about 34.8 metres, and that from ship to shore will be about

**FORTHCOMING EVENTS.**

- THURSDAY, JANUARY 2nd.**  
*Ilford and District Radio Society.*—At the Wesleyan Institute, High Road, Ilford. Lecture by a representative of the Igranic Electric Co., Ltd.  
*Golders Green and Hendon Radio Society.*—At 8.15 p.m. At the Club House, Willifield Way. Lecture: "The Latest in Radio," by Mr. Percy W. Harris.
- MONDAY, JANUARY 6th.**  
*Newcastle-upon-Tyne Radio Society.*—At 7.30 p.m. At Armstrong College. Lecture: "The Evolution of the Receiver," by Mr. J. G. Ogg.
- TUESDAY, JANUARY 7th.**  
*Physical and Optical Societies' Exhibition* (and on January 8th and 9th). At the Imperial College of Science, Imperial Institute Road, South Kensington.  
*The Television Society.*—At 8 p.m. At the Engineers' Club, Coventry Street, London, W. Lecture: "Photographic Problems of Picture Telegraphy," by Mr. W. S. Newton, B.Sc. (Hons.).

34.0 metres. The Deal Beach, N.J., experimental station of the Bell Telephone Laboratories transmits on the wave of 34.8 metres. The *Leviathan* transmitter operates on the wave of 34.0 metres. Telephone circuits from Deal Beach and Forked River, at which latter place the radio receiver is located, lead to a control

room of the long-distance headquarters at 24, Walker Street, New York, of the American Telephone and Telegraph Company, from which are also operated the trans-Atlantic radio channels.

The 34.8 and the 34.0 metre waves are used in the daytime for distances from 250 to 500 miles. For distances in the daytime of less than 250 miles a wave of about 73.0 metres is used to carry the voice from land to sea, and a wave of about 68.3 metres to carry the voice from sea to land. At night the two waves are effective for all distances up to 500 miles or more.

The land transmitter is quite powerful, about 5,000 watts. The ship transmitter is of 500 watt capacity, but since receiving conditions on land are much more favourable than on shipboard, signals strengths from ship to shore and from shore to ship are about equal.

The British Post Office is not so advanced with its experiments as the American authorities, but it is probable that a similar ship-to-shore service will soon be in operation on this side of the Atlantic. Tests will shortly take place on the *Berengaria*.

**TRANSMITTERS' NOTES.**

**Radio Amateur Call-book.**

The December issue of the Amateur Call-book is now published and can be obtained from Mr. F. T. Carter, Flat A, Gleneagle Mansions, Streatham, price 4s. 6d. post free.

The lists of amateur transmitters have been revised and brought up to date; that for Great Britain alone occupies over 24 columns of closely printed matter. The supplementary features include the "Q," "R," and "T" codes, and a list of the principal commercial short-wave stations, with regard to which the publishers specially ask for reliable information concerning new stations working regularly on frequencies above 3,000 kC.

We hope there will be a good response to this request, as up to the present time we have not seen anything like a really comprehensive list of short-wave stations, though we receive constant enquiries from readers who ask if a complete list is obtainable.

o o o o

**Experiments on 170 Metres.**

Mr. S. J. Styles (G 5BQ), 15, Pickwick Road, Dulwich Village, S.E.21, is carrying out experiments on the longer amateur wavelengths and wishes to arrange schedules on the 170-metre wave-band for Saturday or Sundays with stations outside London. He will also appreciate any reports on transmissions received on this wavelength.

o o o o

**New Call-signs and Changes of Address.**

- G 6IO T. Woodhouse-Rayner, 25, The Gardens, East Dulwich, S.E.22. (Change of address and re-issue of licence); transmits on 1740-1970 and 7050-7250 kC. and will welcome reports.
- C 6NM North Middlesex Radio Society (Portable). Hon. Sec., E. H. Laister, "Windflowers," Church Hill, Winchmore Hill, N.21 (Change of address.)

# American Beam Stations



An Account of the Short-wave Achievements of the Bell Telephone Laboratories.

By M. RAY.

At a meeting of the Wireless Section of the Institution of Electrical Engineers in March, 1926, a paper was read by Mr. Shaughnessy describing the remarkable achievement of the General Post Office—the thousand-kilowatt Rugby transmitter completely controlled from a small tuning-fork. Many speakers complimented the engineers of the Post Office and affirmed their belief that this was the last word in transmitting station design. Mr. Vyvyan, the chief engineer of the Marconi Co., also remarked that the achievement was the last word in more senses than one, insinuating that, although only completed a few months, the long-wave Rugby station was already out of date.

He was referring to the short-wave beam stations that were in the course of erection by his company under the guidance of that remarkable engineer, C. S. Franklin. Most of those present, though they were not in the position to contradict effectively Mr. Vyvyan's prophecy, through lack of experimental evidence at their disposal, were well known to be very sceptical regarding the prospects of the employment of short waves for commercial purposes. The last three years have shown that this prophecy, however rash it appeared at the time, was substantially correct for point-to-point transmission.

It is barely two years since the General

Post Office took over the pioneer installations of the Marconi Company, and there are now short-wave beam stations almost all over the civilised world, and more are constantly being added to the number already in existence.

One of the latest installations is that designed by the Bell Telephone Laboratories of America for the American Telephone and Telegraph Company. They have been described in a recent number of the *Bell Records* by the principal engineers in charge of the design.

These stations are of considerable interest and in many ways differ from the original stations built by Franklin. The requirements in these American stations were more stringent, since they were required for telephonic communication, and, in order to obtain reliable service, it was considered that it would be necessary to employ a number of wavelengths, so that when one failed to convey intelligible speech via the Heaviside layer, another wavelength would be used. Each of the transmitters erected by the Bell Laboratories can be used on three different wavelengths of approximately 16, 22, and 33 metres. The transmitters can be readily altered for different wavelengths by changing the coils, but the problem is not so simple for the aerials. These beam aerials can only be designed for a single wavelength, so that each trans-

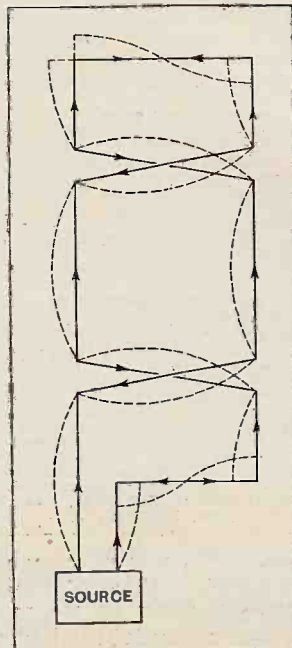

Fig. 1.—An element of the transmitting aerial. The dotted lines show the current distribution.



**American Beam Stations.—**

mission channel has three separate aerial arrangements and a single transmitter. At Lawrenceville, near New York, there are three channels pointing towards England, making a total of nine aerial arrangements, each of which is 500ft. long.

These had to be arranged in a line in order that they might not interfere with one another. The total area of land covered is 800 acres. The aerials are supported on steel towers 180ft. high. Each of them is considerably smaller than those originally erected by the Marconi Company, which used towers 275ft. high and an aerial spread of 1,300ft., but in most cases only a single wavelength, and never more than two, were used, so that the total system for each channel was smaller, but no doubt did not give as high a degree of reliability. The principle of the aerial design differs somewhat from that of Franklin.

An element of the aerial is shown in Fig. 1, in which the dotted lines show the current distribution. The currents in the vertical portions by this arrangement flow in the same direction, while the currents in the horizontal portions practically cancel one another, so that only the vertical portions are effective in producing radiation.

This special form of construction was employed in order to guard against certain dangerous climatic conditions. In the neighbourhood of New York considerable quantities of sleet are liable to condense on wires. To prevent dangerous overloading of the aerials it is proposed to melt the sleet by warming the aerial wires with alternating current at power frequencies. For this

purpose it is essential that the aerial should form a complete metallic circuit, a condition which is obtained in the design shown in Fig. 1. A current of 150 amperes at nearly 1,000 volts is used for the purpose. The power generator is connected across a large condenser, which effectively short-circuits the high-frequency current. This condenser is connected at the end of a quarter-wave line. The reason for this is that such a line, when short-circuited at its end, has a very large input impedance. The combination of this line, condenser, and generator connected directly across the high-frequency generator is of such high impedance to the high-frequency that it will barely affect it.

The reflector system is a similar arrangement situated a quarter of a wavelength behind the transmitting aerial, and excited by direct induction from it. The correct phase relation between the current in the reflector and the aerial is obtained by slightly detuning the reflector system.

**Quartz Oscillator Control.**

The whole aerial system consists of a number of elements such as shown in Fig. 1 situated side by side in a line.

A general view of the grounds at Lawrenceville is shown in the title illustration. The long line of aerials are the three channels for European transmission, the shorter one at right angles to it is a channel for transmitting to South America. The photographs give a closer view of the aerial system. It will be noted that in general outward appearance the construction is very similar to that of the original beam aerial designed by Franklin.

While the thousand-kilowatt station of Rugby is controlled from the almost infinitesimal power of a vibrating tuning fork, these high-frequency 15-kilowatt transmitters are controlled by an even smaller source of power, namely, that derived from a piece of quartz vibrating at the rate of 3,300,000 cycles per second. From these the third harmonic is picked out, and then the second of the result, giving finally the highest frequency used, corresponding to approximately 16 metres wavelength. This is modulated by a two-stage speech amplifier and again amplified by large water-cooled valves, of which there are four in parallel in the last stage.

The construction of the oscillator is apparently straightforward, but the designers had to overcome

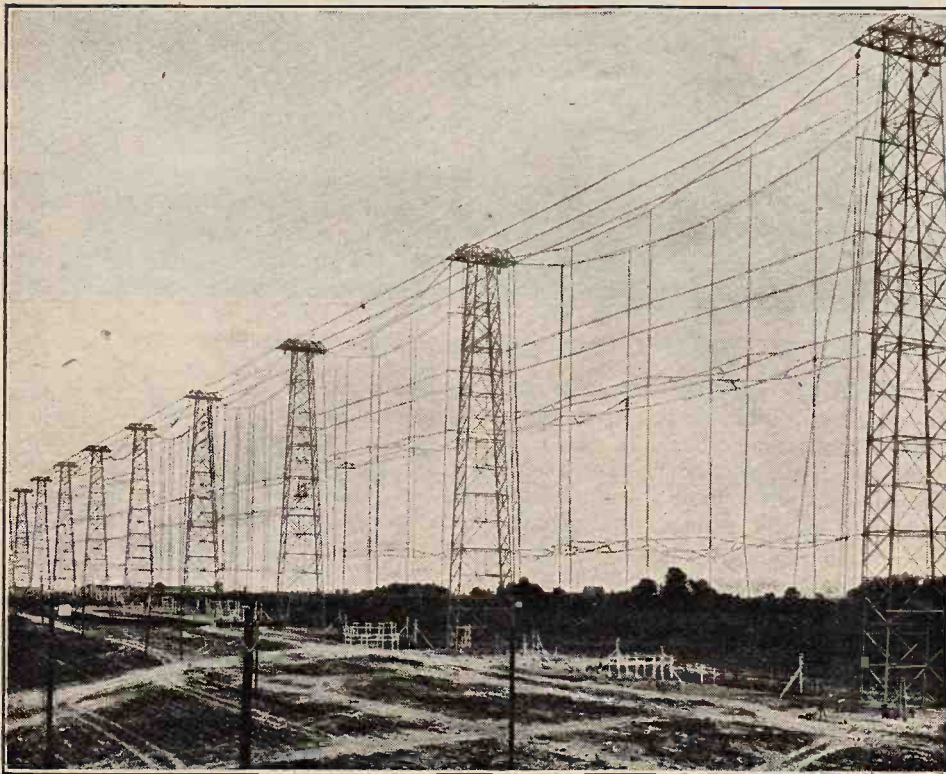

A part of the line of towers supporting the transmitting aerials at Lawrenceville.

**American Beam Stations.—**

considerable difficulties owing to the fact that some of the leads in such large systems are of length comparable to the wavelength and need special coaxing, and also because these high-frequency circuits are liable to break out into various types of oscillations. These may contain extremely high frequencies produced by stray inductances in leads and valve capacities, but they can usually be prevented by the judicious use of resistances.

In construction the power supply and arrangements are along standard lines. One is faced with a bevy of beautifully arranged instruments, switches, knobs, relays, which give the impression like all unfamiliar switchboards of being lost in a large city. An

vertical portions are effective for reception. The reflector is an identical system situated one-quarter of a wavelength behind the aerial, and departs from the usual arrangement in that it is connected to the receiving set in such a way that the E.M.F. induced in it is shifted in phase by  $45^\circ$  before it reaches the receiving set.

The same shift, but in the opposite direction, is given to the signal from the aerial, resulting in a relative phase shift of  $90^\circ$  between the two. This, combined with the distance of separation of a quarter of a wavelength, gives the ideal theoretical condition for a reflector, namely, that it should double the signal received from the required direction, and reduce it to zero if it comes from the opposite direction, the direction of the incoming

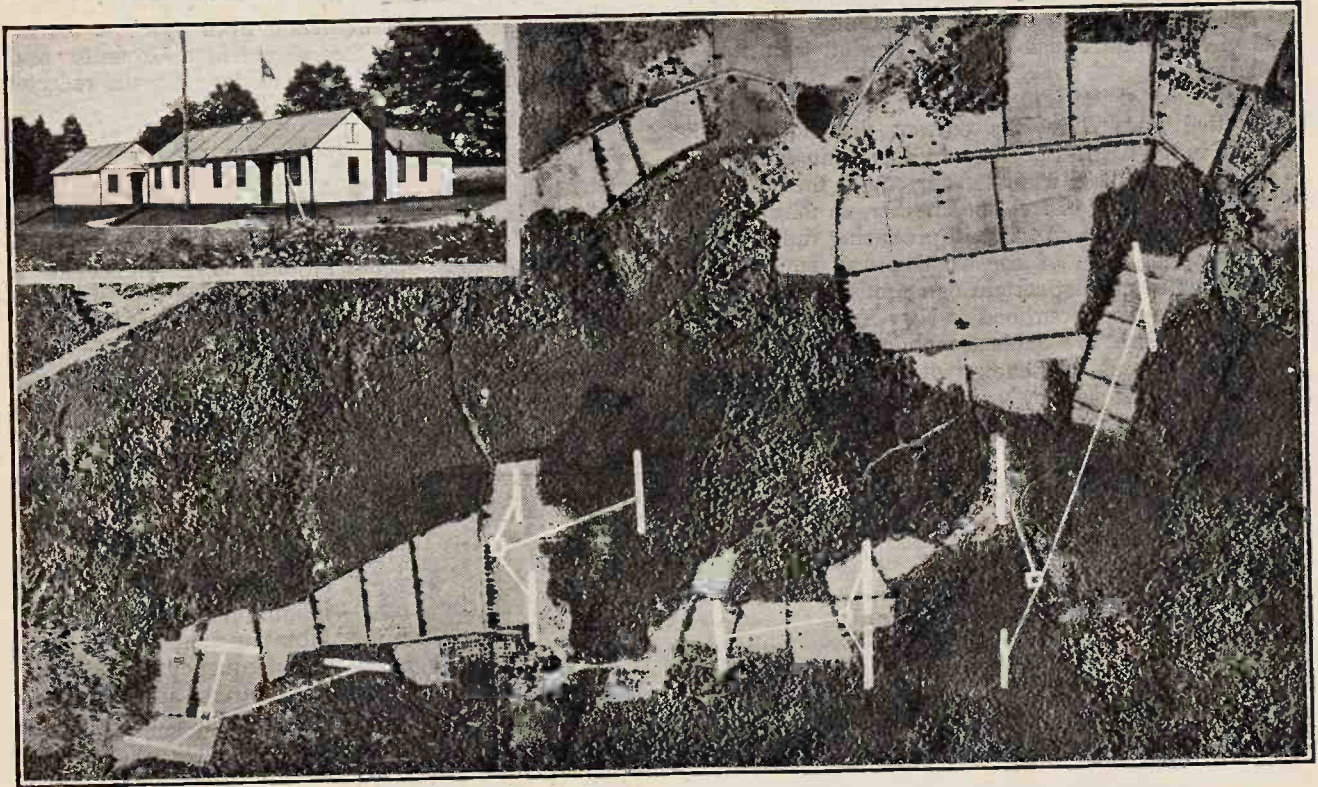

Aerial view of the receiving station at Netcong, New Jersey, showing location of receivers and transmitting aeri-als.

explanation is given of the mechanism of the foolproof devices consisting of interlocking switches, lights that go on when something is wrong, lamps that go out when something is right, bells that ring when the operator falls asleep, cages that one cannot enter without making cabalistic signs, and all the remainder of the safety devices.

**Minimising Atmospheric Disturbances.**

So much for the transmitter. The receiving aerial is of a different design first suggested by Mesny. The construction is shown schematically in Fig. 2, in which the dotted lines show the current distribution. As in the case of the transmitting aerial, it will be seen that the vertical portions carry current flowing in the same direction, while the currents in the horizontal portions are small and largely neutralise each other, so that only the

ray being assumed to be horizontal. Actually this phase shift is adjustable, so that minimum reception is in the direction of the most disturbing atmospheric. Each aerial is six wavelengths long; such a system, it is claimed, receives forty times the power (16 decibels) as that received from a simple half-wave aerial. The whole receiving station, comprising four communication channels, each capable of reception on three different wavelengths, covers an area of 400 acres. An aerial view of the station is shown, together with a closer view of the aerial systems.

The receiver proper is built on the superheterodyne, double-detection principle. The signal is first amplified by means of two stages using screen-grid valves, the frequency is then demodulated to one of 400 kilocycles, which is passed through a narrow band-pass filter, and the signal further amplified through six stages

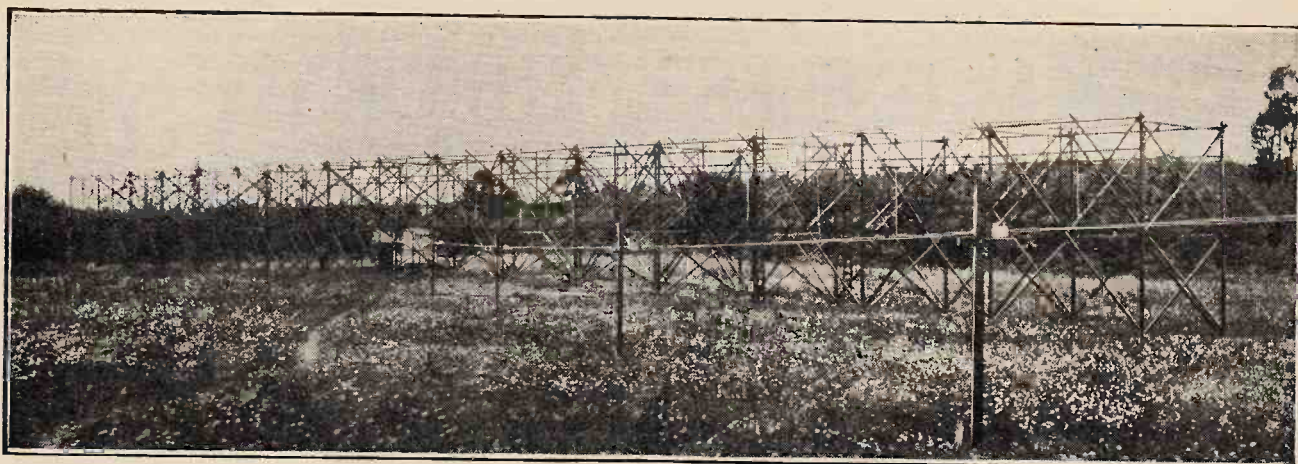

The receiving aerial at Netcon.

at this intermediate frequency. Between the first and second of these stages is inserted an attenuator, which serves the double purpose of volume control and for carrying out certain measurements. Before the last demodulator, from which the speech frequencies are

ments in design that are likely to accrue through the research work which is continually going on, will in time bring long-distance telephony within the financial reach of nearly all. In America already he who lives without a telephone lives in Diogenian bliss, but his race is practically extinct.

It is indeed a pity that the transmission of speech over which so much thought, so much work, so much

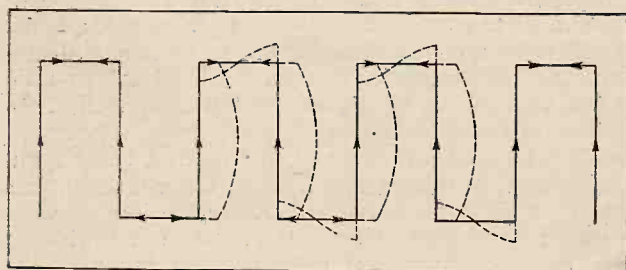
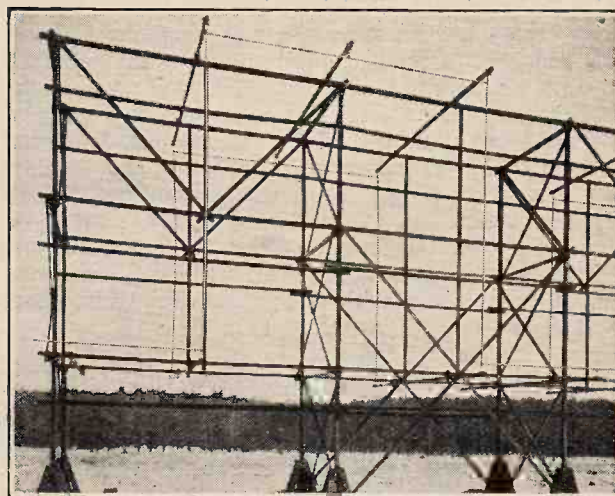

Fig. 2.—Mesny aerial for reception. The current distribution is shown by the dotted lines.

obtained, another band-pass filter is inserted. A single stage of audio-frequency amplification is employed.

The speech is then transmitted along wires to a central building, where it is further amplified and transmitted over land lines to New York. After this our interest completely disappears, but our imagination may allow us to visualise some impossibly square-chinned business man being disturbed in order to listen over the roar of the electrons and the cracklings of Jupiter to some probably unimportant remarks. (Fortunately, the roar is subdued, and the cracklings not too frequent.)

With the help of the photographs kindly lent by the Bell Telephone Laboratories, the author has been able to describe briefly a great engineering success. The use of short-wave beam stations, with the further improve-



One end of a short-wave receiving aerial erected by the Bell Telephone Laboratories.

energy has been spent should reach the end of its journey in the common land line and desk telephone, of the reproduction qualities of which even a parrot would be ashamed.

Messrs. Wingrove and Rogers, Ltd., Arundei Chambers, 188-9, Strand, London, W.C.2.—Illustrated folder of "Polar" condensers and components.

"M.P.A." Wireless, Ltd., 62, Conduit Street, London, W.1.—Illustrated folder of new season's receivers, accessories and components.

**CATALOGUES RECEIVED.**

Fuller Accumulator Company (1926), Ltd., Woodland Works, Chadwell Heath, Essex.—12-page illustrated booklet on the care and maintenance of Fuller accumulators.

Carrington Manufacturing Co., Ltd., Camco Works, Sanderstead Road, South Croydon. — Descriptive leaflet of "Camco" "Paxflat" cabinet for the "1930 Cossor Melody Maker."

Messrs. J. R. Morris, 15, 17, 19, Kingsway, London, W.C.2.—Illustrated folder of Columbia dry-cell H.T. batteries.



## Part XV.—Properties of Tuned Circuits.

By S. O. PEARSON, B.Sc., A.M.I.E.E.

(Continued from page 704 of last week's issue.)

THERE is still a good deal to be said regarding the series type of tuned circuit discussed in the previous part where the conditions for obtaining the highest voltage step-up effect were mentioned. It was found that for optimum signal strength the resistance of the tuned circuit should be low and the ratio of inductance to capacity as high as possible within practical limits. The *product* of inductance and capacity is determined by the frequency or wavelength to be received.

### Selectivity.

In these days when some valves are capable of giving an actual high-frequency amplification of the order of 200 times or more in a single stage, the voltage step-up effect given by the circuit itself is not nearly so important as it was a few years ago when it was a difficult matter to obtain a high-frequency amplification of only twenty times in a single stage. The most pressing problem at the present time, as every reader knows, is that of obtaining a circuit sufficiently selective to enable him to listen to a desired transmission without interference from other transmissions perhaps more powerful than the desired one and operating at a frequency removed by a few kilocycles per second only from that to which the circuit is tuned.

By more or less elaborate arrangements involving two or more tuned circuits it is possible to obtain a very high degree of selectivity, but as we are studying the general theory of a single tuned circuit at the moment, such refinements must be left for subsequent consideration.

The selectivity of a tuned circuit is not very easily expressed as a numerical quantity on account of the peculiar shape of the resonance curve. There are two ways in which one could judge the selectivity of a circuit, and a definition could be given according to which viewpoint is taken. For instance, in tuning the receiver to a given station the object in view is to cause the signals from this station to build up the maximum possible voltage across the tuned circuit whilst at the same time preventing as far as possible any other station, operating on a neighbour-

ing frequency, from setting up a voltage across the circuit. From this point of view the selectivity of the tuned circuit might be defined as the ratio of the voltage obtained across it at the resonant frequency to that obtained at some other frequency differing by a stated number of cycles per second from the resonant frequency, the voltage induced into the circuit being the same in each case.

Since the present frequency separation of broadcast stations in Europe is 9 kilocycles per second, a figure of this order suggests itself for use in the above definition. So the selectivity could be defined as the ratio of the voltages set up across the tuned circuit by two stations of equal strength and where frequency separation is 9 kilocycles per second, the receiver being accurately tuned to one of them. But, unfortunately, this definition, although conveying clearly the idea of what is meant by degree of selectivity, does not lend itself very easily to numerical calculation in terms of the constants of the circuit.

In these circumstances it is better to define the selectivity from the point of view of the change in frequency from the resonant value necessary to reduce the voltage across the circuit to a stated fraction of the maximum value. In the October 16th issue of *The Wireless World* Dr. R. T. Beatty gave a definition on these lines, and explained how a number could be obtained for expressing the selectivity of a tuned circuit as a numerical quantity, and how it could be used for practical calculations. This he called the "selectivity number" of the circuit. It is defined as the ratio of the resonant frequency to the change in frequency necessary to reduce the voltage across the circuit to a value of 10 per cent. of the maximum value. The way in which this selectivity number depends on the constants of the circuit will be explained after we have considered the resonance curves of some actual circuits.

### The Effect of Resistance on Selectivity.

The degree of selectivity necessary to ensure reception of any given station free of interference by another station on a neighbouring wavelength or frequency

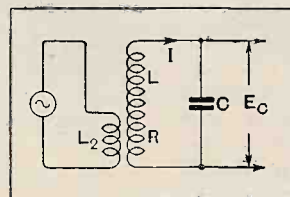

Fig. 1.—Simple series tuned circuit. If a voltage  $E$  is induced into the closed circuit  $LRC$  the voltage  $E_C$  is built up across it at the resonant frequency.  $\frac{E_C}{E}$  is the voltage magnification  $m$  of the tuned circuit and is equal to  $\frac{I}{R} \sqrt{\frac{L}{C}}$ .

**Wireless Theory Simplified.—**

depends on (a) the difference between the two frequencies, and (b) the relative strengths of the two transmissions as measured in the locality of the receiver. The closer the two wavelengths are together and the more powerful the effects of the unwanted station, the greater will the selectivity have to be.

The resonance curves given in Fig. 3 of the previous part show very clearly that when the resistance of the tuned circuit is reduced, the peak of the resonance curve is increased in height *without appreciably changing the width of the hump near the base*. This means that, by decreasing the resistance, we are increasing the strength of the wanted "signal" at the resonant frequency without appreciably increasing the strengths of any signals whose frequencies lie outside the band covered by the hump in the curve. In other words, we are increasing the selectivity by reducing the circuit resistance.

The effects of the resistance, however, on the selectivity of the circuit can be made very much clearer if, instead of plotting the resonance curves to actual values of the voltage, each is plotted to values which are a percentage of the respective maximum values, thereby making all the curves coincide at the maximum point. Accordingly this has been done in Fig. 2 for a series-tuned circuit such as that shown in Fig. 1, where the inductance is 2532 microhenrys and the capacity 0.00025 microfarad, for resistance values of 10 ohms, 50 ohms, 200 ohms and 500 ohms respectively, as indicated on the curves.

These resonance curves show very clearly that reducing the resistance of the circuit has the effect of narrowing down the peak of the resonance curve and so increasing the degree of selectivity. Since the curves have been plotted to scale, we can read off directly the frequency at which the voltage across the circuit is 10 per cent. of the maximum value, and from this we can obtain the selectivity number formulated by Dr. Beatty. For instance, from the resonance curve corresponding to a circuit resistance of 50 ohms, the voltage falls to 10 per cent. of the resonant value at a frequency of 184.3 kilocycles per second. The difference between this and the resonant value of 200 kilocycles per second is 15.7, and so the selectivity number of the circuit is

$$\frac{200}{15.7} = 12.72.$$

When the circuit resistance is increased four-fold to 200 ohms, we find that 10 per cent. of the maximum voltage occurs at a frequency of 137 kilocycles per second. The difference between this and the resonant frequency is 200 - 137 = 63 kilocycles per second. Hence the selectivity number is  $\frac{200}{63} = 3.18$ . This is just one-

quarter of the value obtained for the 50-ohm circuit. By taking further resistance values and the corresponding resonance curves we find that *the selectivity number is inversely proportional to the resistance of the circuit*.

**Effects of L and C on the Selectivity.**

It was shown that the voltage step-up or voltage magnification of the tuned circuit is *also* inversely proportional to the resistance, and so *both the signal strength and the selectivity vary inversely as the circuit resistance*. We can conclude, then, that the selectivity of a circuit is directly proportional to the voltage magnification obtained at the resonant frequency. Now the voltage across the circuit at this frequency is equal to the current in the closed circuit multiplied by the reactance of the condenser or by the reactance of the coil, because these are equal at the resonant frequency—that is, voltage across the circuit is  $E_c = I \times 2\pi fL$ , where  $I = \frac{E}{R}$  at the frequency of resonance, E being the voltage applied to the circuit. Hence  $E_c = E \times \frac{2\pi fL}{R}$  volts, and so the voltage magnification of the circuit is  $m = \frac{2\pi fL}{R}$  at the frequency of resonance. But we already know

$$\text{that } f = \frac{1}{2\pi\sqrt{LC}} \text{ or } 2\pi f =$$

$$\frac{1}{\sqrt{LC}}, \text{ and therefore the}$$

voltage magnification given by the circuit when tuned to resonance is

$$m = \frac{1}{R} \sqrt{\frac{L}{C}}$$

and the selectivity number is proportional to this quantity, which may be looked upon as a sort of figure of merit of the circuit.

For the circuit considered above, with  $L = 2532 \mu\text{H}$  and  $C = 0.00025 \text{ mfd.}$  for a resistance value of 50 ohms the voltage step-up is

$$m = \frac{1}{50} \sqrt{\frac{2532}{0.00025}} = 63.6 \text{ times.}$$

The selectivity number for this circuit was found to be 12.72, which is *exactly one-fifth* of the voltage magnification.

Similarly for the 200-ohm circuit the voltage magnification works out to 15.9 and the selectivity number was 3.18, also exactly one-fifth of the voltage magnification. Hence for a selectivity number calculated on a 10 per cent. basis, as explained above, its value is given for

$$\text{any tuned circuit by } \frac{1}{5R} \sqrt{\frac{L}{C}}$$

**Conditions for Maximum Selectivity.**

Thus from the point of view of obtaining good selectivity with a single tuned circuit, it is a matter of the first importance to make the *effective* resistance as low as pos-

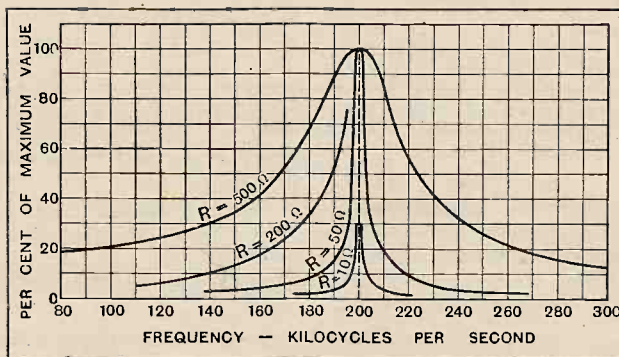

Fig. 2.—Voltage resonance curves for a series tuned circuit showing how the resistance affects the selectivity. Coil Inductance 2532 microhenrys, capacity 0.00025 mfd. Resistance values as indicated on the curves.

Wireless Theory Simplified.—

sible and to choose a ratio of  $\frac{L}{C}$  as large as possible compatible with practical conditions. The effective resistance of the circuit is the *equivalent series resistance* which, when multiplied by the square of the current, gives the total power absorbed by the circuit; it is made up of the actual high frequency resistance of the coil together with an added resistance accounting for any incidental loss of power associated with the circuit but not actually in the coil or condenser. For instance, if the tuned circuit is followed by a detector valve operating on the leaky grid principle as shown in Fig. 3(a), it is actually shunted by a high resistance "load," and the simplified circuit is shown at (b) in Fig. 3, where  $r$  is the effective resistance in parallel with the condenser of the tuned circuit and  $R_1$  is the actual high-frequency resistance of the closed circuit itself. Now since the external resistance  $r$  has a high value, the current in it will be very small compared with the current  $I$  in the coil  $L$ , and so we can still take the current as being of equal value all the way round the closed circuit without introducing any appreciable error.

The power loss in the closed circuit is  $I^2 R_1$  watts and that in the external resistance  $r$  is  $\frac{E_c}{r}$  watts, where  $E_c$  is the voltage across the circuit at resonance, being equal to  $I \times X_c$ , where  $X_c = \frac{1}{2\pi f C}$ . Hence the power expended in the external shunt resistance  $r$  is  $\frac{I^2 X_c^2}{r} = I^2 \times \frac{X_c^2}{r}$  watts; and so a high resistance in parallel with the tuned circuit is equivalent to an extra series resistance of  $\frac{X_c^2}{r}$  ohms within the closed circuit itself.

Thus if  $R_1$  is the effective resistance of the unshunted tuned circuit, and if this circuit is then shunted by a high resistance  $r$ , the effective resistance of the circuit becomes

$$R = R_1 + \frac{X_c^2}{r} \text{ ohms,}$$

and in consequence both the selectivity and the signal strength are reduced. The equivalent circuit is shown in Fig. 3(c).

Damping Effect with Leaky Grid Rectification.

As a practical example we can consider the same tuned circuit cited previously, namely, where  $L = 2532$  microhenrys,  $C = 0.00025$  microfarad, and assume that

the effective resistance of the circuit itself with the valve disconnected is 50 ohms. The voltage magnification obtained would be  $m = \frac{1}{R} \sqrt{\frac{L}{C}} = 63.6$ . Suppose now that the leaky grid detector valve is connected across the circuit and that it introduces an equivalent shunt or parallel resistance of 1 megohm or  $10^6$  ohms. This is equivalent to increasing the *series* resistance of the circuit by  $\frac{X_c^2}{10^6}$  ohms. The resonant frequency is 200 kilocycles per second, and therefore the condenser reactance

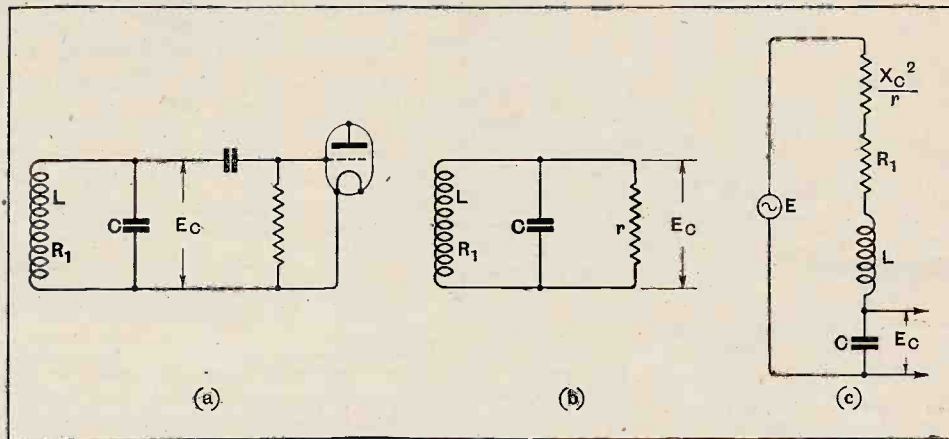

Fig. 3.—When a tuned high-frequency circuit feeds a leaky grid detector it is shunted by an equivalent resistance  $r$  as shown in (b). This in turn is equivalent to adding an extra resistance  $\frac{X_c^2}{r}$  in the tuned circuit itself.

$X_c$  is 3182 ohms. Hence the extra resistance imparted to the circuit by the valve and its grid leak is

$$\frac{X_c^2}{r} = \frac{3182^2}{10^6} = 10 \text{ ohms.}$$

So the total effective resistance of the tuned circuit is increased from 50 ohms to 60 ohms in this case, and the voltage magnification reduced from 63.6 to 53. Obviously the lower the effective resistance of the tuned circuit itself the more pronounced will be the "damping" effect of a leaky grid detector or any other shunting resistance. Thus when a high frequency tuned circuit is designed to have the maximum possible efficiency, it should preferably be followed by an "anode bend" detector if the selectivity is to be unimpaired, because anode bend rectification introduces very little damping. (To be continued.)

o o o o

WORLD-TIME INDICATOR.

Messrs. J. H. Willis and Co., Ipswich Road, Norwich, have sent us their new model World-Time Indicator. A description and illustration of this device appeared in our issue of May 8th, 1929. In the new model several more countries have been included, the wording of the instructions slightly amended, and the edge of the dial is now milled. The price is 1s. 6d.



By Our Special Correspondent.

**A Programme Dilemma.—The King at the Microphone.—What Will 1930 Bring ?**

**To Be or Not to Be?**

The New Year finds the B.B.C. Programme Department in a disturbing predicament. The ordinary task of filling programme time for six weeks ahead is sufficiently harassing; add to it the possibility, but not the certainty, that an extra full-blown daily programme will be required in a month or two, and the worried looks at Savoy Hill are fully accounted for.

o o o o

**Watch the Educationists.**

The outcome of the present twin transmission tests from Brookmans Park will determine whether an additional programme is to be available, and already a number of optional items have been pigeon-holed for use at a moment's notice. I understand that these include a good sprinkling of talks; in fact, it looks as if the alternative regional programme might easily be commandeered by the educational group. Possibly listeners are in favour of such a step, but I very much doubt it. No one denies that broadcast education is handicapped at present by lack of programme time, but the B.B.C. would do well to ensure that the educationists are not allowed too big a bite from the new cake.

o o o o

**H.M. The King.**

The outstanding broadcast event in January is, of course, the relay from the International Disarmament Conference at the House of Lords on the 21st, when H.M. The King will use the microphone again for the first time since his illness.

I hear that the B.B.C. will install no fewer than ten microphones in different parts of the Royal Gallery. These will be operated from a control point just outside the Chamber, linked to the Post Office "PBX" (Private Branch Exchange), and thence to Savoy Hill.

The relay, which will last two hours, will begin at 11 a.m. with the King's opening speech, after which His Majesty will leave the Royal Gallery, his place being taken by the Prime Minister. The broadcast is expected to include speeches by representatives of the great naval powers and delegates of the Dominion Governments.

**A Bumper Broadcast Year.**

It is doubtful whether any year can eclipse 1929 for the importance and variety of its broadcast events. On the constructional side the year saw the practical completion of the first regional station, the installation of a new listening post at Tatsfield, and the spade work preliminary to the erection of Broadcast House, Portland Place.

In the North work was started on the site for another regional transmitter.

o o o o

**Programme Progress.**

On the programme side, the B.B.C. deserve congratulation for several really "star" features during 1929. At the top of the bill came the broadcast of the Schneider Trophy Race, carried out in a masterly fashion by an "O.B." staff who are now masters of the game of bringing outdoor events to the home of the listener.

The list of notable speakers who faced the microphone in 1929 is formidable enough. It includes the Prince of Wales,

the Duke of York, the Prime Minister, Mr. Philip Snowden, Sir James Barrie and Sir Henry Segrave, to name only a few.

o o o o

**Can Savoy Hill Maintain the Standard ?**

Radio drama discovered a new technique in "Squirrel's Cage," which fully deserved its repeat performance, while the Talks Department amply justified its existence by the introduction of the "Points of View" series.

Taken all round, it has been a good year for broadcasting, and I am afraid that the B.B.C. may have some difficulty in maintaining the standard. Anyway, here's good luck to them!

o o o o

**Old Bore's Wireless Almanac for 1930.**

*January.*—Old Bore sees a million listeners resolving not to listen again until B.B.C. improves programmes.

*February.*—Unhappy million resume listening to see if programmes have improved.

*March.*—Still listening.

*April.*—Coming to a decision.

*May.*—Dissatisfied; another million switch off.

*June.*—B.B.C. loses patience and closes down. Public outcry.

*July.*—A nation starving for entertainment.

*August.*—Cabinet meeting discusses plans for emergency programmes.

*September.*—Rugby, Northolt and Wick Radio broadcast Clapham and Dwyer. Adult education from Cleethorpes.

*October.*—B.B.C. behind barbed wire at Brookmans Park. Aberdeen station opens subscription list for announcers' families.

*November.*—Tactful mediation of Postmaster-General brings B.B.C. back to Savoy Hill. Programmes resumed.

*December.*—Old Bore sees a million listeners resolving not to listen again until programmes are improved.

o o o o

**Things We Want to Know.**

Whether a certain artist often visits the Queen's Hall, and, if so, whether he still sees the organ pipes as sausages in mass formation.

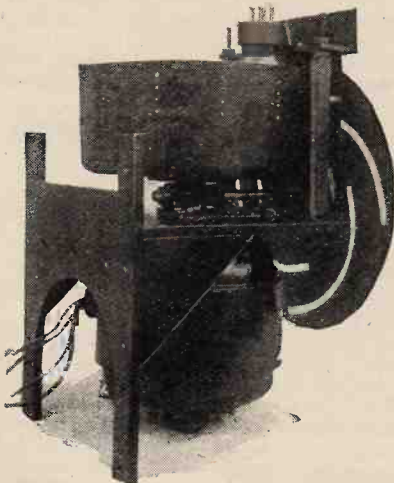

**TELEVISION IN AMERICA.** Regular television programmes are now broadcast by W2XCR, New Jersey, using the Jenkins apparatus. The photograph shows the interior of a Jenkins receiver. Note the rotating drum with its vertical scanning holes and neon lamp.



The Editor does not hold himself responsible for the opinions of his correspondents.

Correspondence should be addressed to the Editor, "The Wireless World," Dorset House, Tudor Street, E.C.4, and must be accompanied by the writer's name and address.

#### SUPPLY REGULATION AND MAINS UNIT.

Sir,—May I make the suggestion that users of D.C. units on mains which are expected to be changed over to A.C. should apply to their local electricity works to approve of the unit? The local authority can only refuse to approve the unit on certain obvious grounds (an anticipated change over to A.C. is not a reasonable objection). Having approved the unit, the supply company is, I believe, bound to provide an A.C. unit when they change over to A.C.

ERNEST J. BATY.

Luton, Beds.

#### ARE AUTUMN SHOWS TOO LATE?

Sir,—It is common knowledge that those who attend the annual Motor Show at Olympia, and order new motor cars, frequently have to wait until the following spring before they obtain delivery. Luckily, the spring is just the time when most people desire to put new cars into commission. With the wireless public the position is less fortunate. The annual Wireless Exhibitions in London and elsewhere are held about October, and those who attend and order new sets or new components naturally expect to be able to use them during the coming winter.

My experience may have been unusual, but it has been as follows:—

(1) A month or so ago I made enquiries about a new moving-coil loud speaker which received much favourable comment at the recent exhibition at Olympia. I was told that, if I decided to wait so long, I might be able to obtain one next January.

(2) I found the published characteristics of a certain new power valve met my requirements. Upon asking my local dealer about it I was told that he had ordered some of these valves weeks ago, but had not been able to obtain any.

(3) For some unknown reason, the English manufacturers appear content to allow the Americans to hold more or less a monopoly in the sale of variable wire-wound resistances and power potentiometers, though these components are required in practically every home-made wireless set and H.T. unit. To my joy, I recently saw an advertisement of an English power potentiometer. I ordered one. I am still waiting for it.

All these components were advertised for sale by firms of first-rate standing.

Now, I quite appreciate that the manufacturers may say that, until the Wireless Exhibitions are held, they do not know what the demand for any particular component is likely to be, and they do not want to manufacture goods wholesale unless they are satisfied that there will be a ready market for them.

If this is their attitude I suggest that the annual Wireless Exhibitions are held at the wrong time of the year. They should be held earlier, so that those who order goods may have some hope of obtaining them at the time when they are most wanted, the autumn.

A. H. GREGSON.

Westcliff-on-Sea.

#### THE SUPERHETERODYNE.

Sir,—The superhet receiver can scarcely be said to have ever enjoyed a popular vogue in Britain, but by serious experimenters it has long been held to be a valuable instrument; nor do those who have had experience of its use consider that its sphere of usefulness is past. It was therefore with some surprise that many read, in two separate articles published by you in November—"Radio in France" (6.xi.29) and "Receiving Sets of To-day" (20.xi.29)—remarks which appeared to convey that the authors of the articles thought the superhet obsolete. So

little did the present writer believe that this was the considered opinion of the technical experts of *The Wireless World* that he confidently expected (following Mr. Cocking's recent article on bandpass filters) that the next *Wireless World* set would certainly be a superhet with bandpass filters, probably based on the "Record Three," i.e., with a single high-magnification I.F. stage, or the "Kilo-Mag" with two I.F. stages.

Selectivity and high-quality production are the most urgent needs. The selectivity of the superhet has never been questioned; that it can also give the highest quality of reproduction may not be so well known, but one would have thought it to be evident from a study of Mr. Cocking's article on bandpass filters in your issue of October 30th, 1929. Obviously the easiest application of the bandpass filter having a constant channel-width is to fit it to the input of the I.F. stages of a superhet.

Since Easter the writer has experimented with superhets in which carefully tuned bandpass filters and I.F. transformers were embodied, and for quality the present hook-up is hard to beat. The eminent organ-builder and master of acoustics, Mr. John Compton, hearing the writer's set, likened it to a big chorus of Schulze diapasons—a term which conveys to those familiar with organ design and technique a tone picture of a quality not to be mistaken, and which may be explained as connoting the presence of solid foundation tone from 16ft. pitch upwards, accompanied by the fullest harmonic development of which the upper members of the family are present in such power and brilliance as to constitute a perfect blaze of tone.

It may be that the superhet in question differs from the usual type somewhat, but there is neither magic nor secret about it. Anyone could build it without much trouble; possibly, as did the writer, largely out of parts from previous sets. There is not an excessive number of valves, and two of them (the modulator and the detector) have no H.T. on their plates. What perhaps is unusual is the intermediate frequency, which, to obviate repeats and harmonics, is fixed at 478.4 kh. Aerial and oscillator coils, bandpass filters, and I.F. transformers are accurately tuned, the filters and transformers by a fixed condenser, a semi-variable condenser, and a small variable condenser, all in parallel. The filter and transformers, of course, only require this to be done once for all. There is in all cases a very high ratio of inductance to capacity.

J. T. H. BURREL.

Millbank, S.W.1.

Sir,—One of your correspondents who signs himself "Super Het" wants three reasons for the unpopularity of the superhet type of receiver in England. As a superhet enthusiast, may I be allowed to state my opinion on the matter? Of the several available reasons, here are what I consider the three more important:—

- (1) Insularity. The superhet is essentially a long-distance receiver, and the bulk of the listening public in England takes not the slightest interest in events outside her shores.
- (2) The mistaken idea, chiefly prevalent in England, that the superhet is incapable of high-quality reproduction.
- (3) The absence on the British market of efficient valves of low price and low upkeep cost.

With regard to (2), the superhet is peculiar in that there is no other circuit capable of giving more appalling reproduction if badly designed. If due precautions be taken, however, it would be difficult to equal, let alone surpass, the good quality this circuit is capable of. With regard to (3), British valves



are from 30 to 50 per cent. dearer than corresponding Continental types. Moreover, the latter are considerably more economical in both filament and anode consumption (wattage). No one in his senses on the Continent would consider a H.F. valve with a filament consumption of more than 0.06 rating (at 4 volts), whereas in England this type (at 6 volts) is the exception.

Nice, France.

I. F. A.

Sir,—Your correspondent "Super Het" in your issue of December 4th writes a short letter on a stupendous subject.

One reason why the superheterodyne is not in use here is because the wireless Press have not devoted time or space to its development.

They despise the super and condemn it as being obsolete, instead of adapting its use to the new order of things, i.e., S.S. valves, pentodes, etc. A combination rightly adjusted would produce the ultimate in receivers.

Another reason is the difficulty of getting really good transformers. The only ones that can be called "good" are the American.

A third reason is that of cost. Factory-made receivers are good, bad and indifferent, and their price prohibitive to the average man—£60, £80 and £100 being the list price of several "obsolete" British makes.

Lastly, upkeep costs are supposed, quite wrongly, to be terrific for eight or nine valves, regardless of the fact that modern valves consume but 0.1 of an amp.

I have many more reasons and plenty more to say, but time and space are valuable.

FRAME AERIAL SUPER 8.

#### FOREIGN WIRELESS GOODS.

Sir,—For some days I have been trying to purchase various wireless components which are in general demand, and it has been brought home to me very forcibly how the conservatism of British manufacturers is losing for our country the considerable trade in wireless goods.

It is a source of amazement to me how they can sit back and allow foreign articles to oust their own from the market. One finds, on asking for British makes, that the shops are invariably out of stock, and can offer no reassurance as to when delivery of the British article can be expected.

I was recently offered a German equivalent of a certain component, and one certainly cannot in most cases follow the maxim "Buy British Goods" in the wireless trade, as the Germans particularly are alive to the possibilities of the British market and appear to be flooding us with their goods to the great detriment of the wireless trade throughout this country, to say nothing of various other trades.

Can nothing be done to remedy this sad state of affairs?

Herts.

F. NICHOLS.

#### PICTURE TRANSMISSIONS.

Sir,—The discontinuance of these transmissions by the B.B.C. must have come as a disappointment to many like myself who had purchased or constructed the necessary apparatus.

The B.B.C. may retort that there are still the Continental transmissions to be received. This is true, and I myself have received some excellent pictures from Vienna in the evenings from Königswusterhausen, but atmospheric and other disturbances are always apt to spoil the picture.

On the other hand, I should imagine that the majority of people constructed their apparatus on the strength of the B.B.C. transmissions, and were hardly influenced at all by the thought that Continental stations would also transmit on the same system.

If the B.B.C. are going to treat television enthusiasts in the same way the average man will not bother his head about it, and true television will be further off than ever.

Cheadle, Cheshire.

WALTER ADDEY.

#### TRACKING H.F. RESISTANCE.

Sir,—In studying the subject of H.F. resistance in some of your back numbers recently, I was much impressed by the articles by A. L. M. Sowerby, M.Sc., in *The Wireless World* for December 19th and 26th, 1928.

A 35

In these definite measurements were given for commercial apparatus, and comparisons made between different models of the same class of article.

The results are so remarkable that I consider it worth while to see if an improvement could be effected in my "Empire Broadcast Receiver" (*Wireless World*, June 29th, 1927).

The detector valve holder appeared to correspond with the description of valve holder "A" in the article referred to.

The valve sockets were cut out of the bakelite moulded centre-piece, there being still sufficient length to make them serviceable. The H.F. end of the grid-leak was disconnected from its clip and left free.

The improvement in strength and quality was marked, and in consequence it was decided to go a step further and remove the valve cap. After this had been removed there was a still greater improvement in performance, but an unlooked for trouble cropped up—that of extreme microphonic resonance, which was bad enough on the telephone, but impossible with the moving coil loud speaker.

In all three attempts were made to overcome this trouble, as the results achieved justified the expenditure of a little research to see if it were possible to overcome this defect.

In the third attempt the valve connections were sheathed in rubber sleeving (bicycle valve tubing) and the pinch tube packed tightly with cotton wool. The glass was mounted in a light brass cage, for the purpose of holding it, by means of Sorbo sponge pads. The valve and holder were then placed in a cardboard tube with a lid, and packed as tightly as it was possible to do so without damage to the glass, with cotton wool.

All attempts failed to cure the trouble, and whether the aluminium container was open or shut loud speaker reception was practically impossible and telephones little better.

On recapping the valve, a DEL610, its behaviour was normal. So far as this particular sample was concerned, it would appear that the "inferior quality" cap was essential to its success, and that microphonic effects come from other avenues than the glass envelope of the valve, as every precaution was taken to damp this out, and certainly the glass itself could not possibly have been a contributory cause.

Any suggestions from readers will be welcome.

WILFRED H. MILES.

Zaria Province, Northern Nigeria.

#### TELEVISION.

Sir,—Mr. H. Graham Mallett, your correspondent, whose letter appeared in your issue of November 27th, overlooks the fact that Dr. Lee De Forest has not, evidently, seen the state of television in England. His remarks, presumably, are based upon the American results. The shadowgraphs of Jenkins bear no resemblance to true television such as is now being demonstrated in London. The images in this country are now so extremely clear that it is possible, as mentioned in a recent editorial of *The Wireless World*, to read the time on a watch.

Sir Ambrose Fleming, the inventor of the valve, bears views entirely contradictory to those of Dr. Lee De Forest, and Sir Ambrose Fleming has had the opportunity of thoroughly inspecting British television, and can, therefore, speak with authority.

Without in any way detracting from the pioneer work of Dr. Lee De Forest, surely it is better to take the facts as they stand in this country. Television by the Baird process is being broadcast by the B.B.C. for 5½ hours each week, and the results have been so satisfactory that this time is now to be increased by a further 2½-hour period per week.

Added to this, comes the *authentic* news that a minimum of a thousand Baird "Televisor" receivers are now in course of manufacture, and will be available very early in the New Year. Many more can then judge this science for themselves instead of coming to conclusions as a result of hearsay.

As one who has been privileged to witness many demonstrations of television, both by wire and wireless in this country and abroad, and can pay tribute to the wonderful progress that has been made in the Baird system, I should like to add my humble meed of praise to that of Sir Ambrose Fleming.

Mill Hill, London, N.W.7.

H. J. BARTON CHAPPLE.

# LABORATORY TESTS.

A Review of Manufacturers' Recent Products.

## COUNTERBALANCED PICK-UP ARM.

A gramophone pick-up arm designed to take most of the well-known makes of electric pick-ups has been placed on the market recently by the E.M.G. Hand-Made Gramophones, 11, Grape Street, New Oxford Street, London, W.C.2. Its principal features lie in the number of adjustments that can be made: the length of the arm is variable, the pick-up carrier can be changed to suit the particular model favoured, and the pressure of the needle on the record can be varied by means of an adjustable counter-weight.

Having provided all these adjustments, it is a pity that the designers have not added one more which would permit the pick-up to be set at an angle to the carrier arm, thereby affording an adjustment for track alignment.

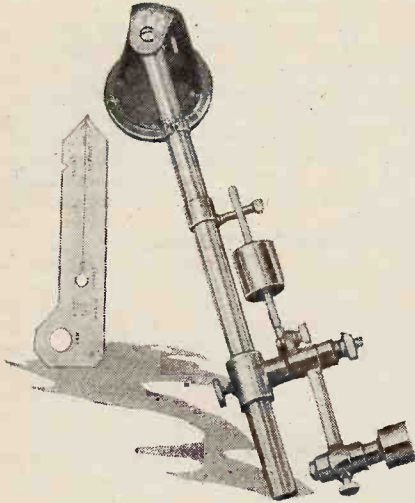

The E.M.G. pick-up arm with a multiplicity of adjustments.

The E.M.G. pick-up arm is handsomely finished, the pivot support being oxidised, and all other parts heavily nickel-plated. It is marketed at 45s. The makers recommend for use with this arm the Phonovox E.M.G. pick-up, which has been especially designed for fibre needles and is priced at 40s.

## "CLIMAX" EARTH TUBE.

The importance of a good earth connection cannot be overstressed, as, in addition to improving reception, it affords a greater factor of safety when the aerial is "earthed" during electrical storms. A direct connection is preferable to a water-pipe earth, but achieving this ideal is less arduous than may at first be thought.

The "Climax" earth tube offers a ready solution, and it costs 5s. only. It is made of hard drawn copper tube, re-

inforced to prevent buckling, and provided with an iron-shod tip to facilitate driving into hard soil. Holes are drilled at intervals along its length, and during dry spells water can be poured down the

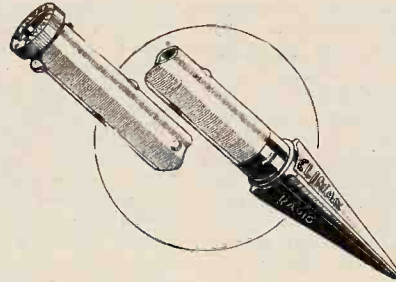

"Climax" earth tube with iron-shod tip and reinforced stem.

hollow centre. Percolation into the surrounding soil takes place and thus a good earth is maintained.

The makers are the Climax Radio Electric Co., Haverstock Works, Parkhill Road, Hampstead, London, N.W.3.

## EATON SCREENING CABINETS.

Metal cabinets of standard dimensions, in which the functions of screen and container are combined, are now being produced by Messrs. Samuel Eaton and Sons, 66-72, Barr Street, Birmingham. These are fitted with a wooden base, and are made in conformity with suggestions put forward in the pages of this journal.

Two distinct types are produced: one is a double-compartment container intended primarily for "The Wireless World Kit Set," while the other has four compartments, and its dimensions are suitable for housing the "Kilo-Mag Four," "1930 Everyman Four," or "Re-

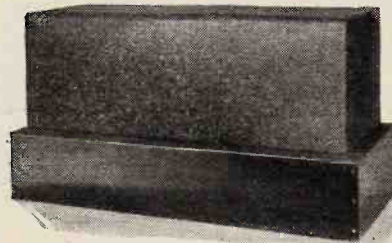

Eaton metal cabinet, with two screened compartments.

cord III." These are priced, respectively, at 38s. 6d. and 46s. 6d.

Metal channels are fitted round the outer edges of the removable cover, and also to the edges of the crosswise partitions, and as one of the lips of each of these channels is sprung inwards contact is made between the cover and the corresponding edges of the base projections at

a number of points. Electrical "sealing" will be adequate for average requirements, but where complete isolation is necessary rolled strips of metal gauze or similar material can be readily inserted in the channels.

External metal-work is finished in crystalline enamel, several colours being available. To compensate for the fact that the plywood sub-base is sunk into the base compartment, the depth of the plinth is somewhat greater than usual; this is all to the good, as the extra space afforded will often be useful, but this must be borne in mind when determining the positions of condenser control dials.

o o o o

## I.D.S. REJECTOR.

Those unfavourably situated with respect to a Regional Station need not despair, as a rejector should help to overcome any difficulty they may have in receiving alternative transmissions. In fact, the I.D.S. "Regional Station Eliminator" has been introduced to cope with such cases. It consists of two coils, wound concentrically on a former;



For unselective sets—the I.D.S. Rejector.

one coil is connected in series with the aerial lead to the set and the other is tuned by a variable condenser. The tuned circuit forms an absorption type rejector.

A practical test was made on a rather unselective receiver, on which 2L0 could not be tuned out at any part of the 250-600 metre waveband. With the rejector in use the interference was restricted to a small band of wavelengths between 344 metres and 367 metres only; transmissions above and below these limits being received free from interference from the Regional Station.

The rejector is built into a moulded case 3in. in diameter and 4½in. high, with two terminals on the side for attachment of aerial lead and connection to set respectively. The rejector tuning control is mounted on the top.

The price of this useful accessory is 10s. 6d., and the makers are The I.D.S., Ltd., 4, Golden Square, Piccadilly Circus, London, W.1.

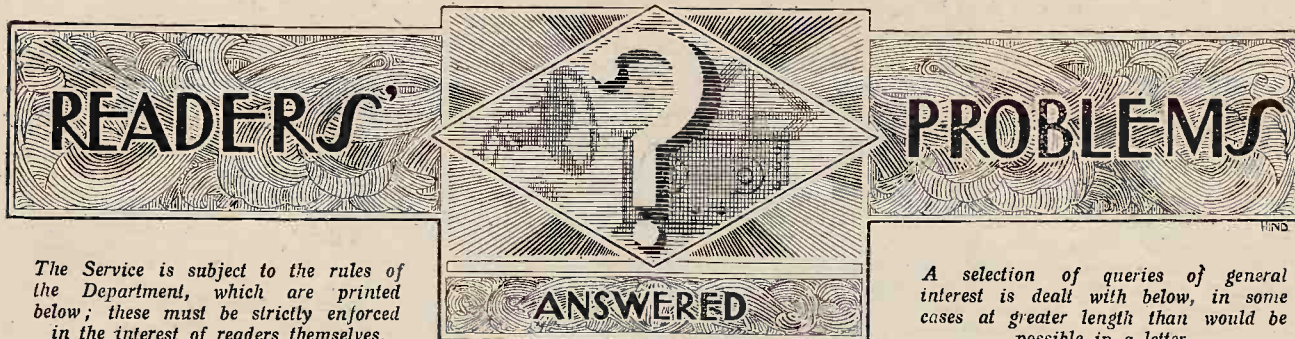

The Service is subject to the rules of the Department, which are printed below; these must be strictly enforced in the interest of readers themselves.

A selection of queries of general interest is dealt with below, in some cases at greater length than would be possible in a letter.

"The Wireless World" Supplies a Free Service of Technical Information.

**Increasing Selectivity and Range.**

With regard to the addition of a tuned aerial circuit to the New Kilo-Mag Four, will you please say if this would have any noticeable effect in increasing range? B. W. R.

Although the conversion in question is primarily intended to increase selectivity, as compared with that of the original "aperiodic" arrangement, it is a fact that, under average working conditions, the use of a two-circuit aerial tuner adds very considerably to the effective range of the set. This is partly because it is generally necessary, in the interests of selectivity, to reduce the coupling of the "untuned" aerial to a value well below that giving maximum signal strength.

o o o o

**Improving the Hartley Circuit.**

(Referring to previous correspondence)

... Many thanks for your reply to my last letter; the tendency towards instability on the long waves of my "Hartley" det.-L.F. set has been completely cured by connecting a 0.0001 mfd. fixed condenser directly between anode and negative filament terminals of the detector valve, as recommended by you. There has been also a general improvement in sensitivity, as you suggested would be probable, but your fears that reaction feed-back might be insufficient over the whole medium waveband prove to be justified; it is impossible to provoke self-oscillation over about one-third of this tuning range unless the extra condenser is removed or disconnected.

Can you suggest a method whereby reaction control may be improved over both wavebands, bearing in mind that, as the set is shortly to be "scrapped" in favour of a more ambitious receiver, I do not wish to spend much time or money on the alterations. B. C. O.

It is suggested that you should replace the fixed anode by-pass capacity by an inexpensive semi-variable condenser, perhaps of the compression type, with a maximum capacity of 0.0003 mfd. This component should be mounted in a reasonably accessible position, and your aim should be to find a setting for it that is suitable for each waveband. Critical

reaction adjustment will be effected by the normal control condenser R.C. (see Fig. 1).

It will be realised that C. and R.C. are interdependent: as the value of the

effects are decreased. It is quite easy to find the best setting of C. by trial and error. Properly adjusted, this arrangement is distinctly more sensitive than the conventional "Hartley" detector circuit.

o o o o

**House-Lighting Systems.**

I was interested in your recent reply to "V. W. P." on the subject of using a house-lighting plant for charging an L.T. accumulator, as I myself have been thinking of using the end regulating cells of my own installation for this purpose.

Actually, there are four extra cells that are not normally used, and it is assumed that their voltage would be sufficiently in excess of that of my 6-volt wireless battery for satisfactory charging. What value of resistance should be inserted to reduce current to 3 amps? G. A.

A 6-volt battery can certainly be charged quite satisfactorily from four of the comparatively large cells used for house lighting, and, as regulating cells are often overcharged through lack of use, it is all to the good that they should be worked.

A series resistance of approximately 0.7 ohms will be needed.

o o o o

**A Neutralised "Kit Set."**

Will you please tell me how the H.F. stage of "The Wireless World" Kit Set (which I am about to build) may be neutralised in order to increase magnification? I presume that a very considerable gain should be possible by making this addition to the published design. W. B. P.

We should strongly dissuade you from attempting this alteration, as the design does not readily lend itself to modification in this way. In order to make neutralisation worth while, sweeping changes would be necessary; indeed, an adequate discussion of the matter would be rather beyond the scope of the Information Department.

If you must have a "balanced" set, we think you would be well advised to adopt the main features of the "Record III," but we would assure you that the very considerable H.F. amplification of the Kit Set, plus reaction, provides as much sensitivity as is necessary under average conditions.

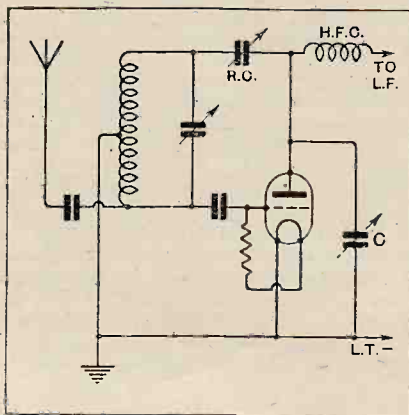

Fig. 1.—Detection efficiency—and sometimes reaction control—may generally be improved by adding an anode by-pass condenser to a "Hartley" circuit.

latter is increased, a greater proportion of the total oscillatory energy in the detector anode circuit is by-passed to earth, and, for a given setting of R.C., reaction

**RULES.**

- (1.) Only one question (which must deal with a single specific point) can be answered. Letters must be concisely worded and headed "Information Department."
- (2.) Queries must be written on one side of the paper, and diagrams drawn on a separate sheet. A self-addressed stamped envelope must be enclosed for postal reply.
- (3.) Designs or circuit diagrams for complete receivers cannot be given; under present-day conditions justice cannot be done to questions of this kind in the course of a letter.
- (4.) Practical wiring plans cannot be supplied or considered.
- (5.) Designs for components such as L.F. chokes, power transformers, etc., cannot be supplied.
- (6.) Queries arising from the construction or operation of receivers must be confined to constructional sets described in "The Wireless World" or to standard manufacturers' receivers.

Readers desiring information on matters beyond the scope of the Information Department are invited to submit suggestions regarding subjects to be treated in future articles or paragraphs.

**Back to the Neutralised Triode?**

Although the screen-grid valve has obvious advantages in a set with a single highly efficient stage of H.F. amplification and in the matter of ease of waveband switching, a careful consideration of recent articles and receiver designs published in your journal has led me to form the opinion that in a "2 H.F." set for the broadcast waveband only neutralised triodes would provide all the amplification necessary (with a good aerial) and would be less costly than the expensive S.G. valves.

Thanks to modern developments such as decoupling and to a fuller use of screening than in the days when neutralised intervalve couplings were popular, it should now be an easy matter to attain nearly the full possible theoretical magnification from each stage, using valves costing less than half the price of those customarily used nowadays.

If you agree that a neutralised triode set is still worth while, will you please give me a circuit diagram of a two-stage amplifier with two-circuit aerial tuner, H.F. transformers, and decoupling devices where necessary. If you recommend it, I will screen the valves from the coils and condensers. T. H. W.

There is a good deal of truth in what you say in favour of the neutralised triode, but we think you tend to exaggerate the increased cost of the S.G. valve amplifier, which normally does not require neutralising condensers or the comparatively expensive coil necessary for constructing a superlatively good H.F. amplifier for three-electrode valves.

It is correct enough to assume that two of these valves, used to best advantage, can provide a theoretical amplification quite as great as that of the average set with the same number of screened valves, and that modern stabilising devices make it much easier to attain something approaching the maximum possible gain from each stage.

The circuit diagram given in Fig. 2 should meet your needs; positions of screening partitions and decoupling devices are indicated. With regard to isolating the valves from the apparatus associated with the H.F. circuits, this procedure cannot do any harm, if carefully carried out, but it is hardly likely to confer any very noticeable benefit; it must be remembered that in a neutralised set (as opposed to an S.G. valve amplifier) any stray capacitive couplings can be balanced out. o o o o.

**H.T. Feed.**

I have an eliminator with three positive supply terminals, one marked "power," another "120 v," and a third "0-100 v." The output from the "power" terminal is stated to be 160 volts at 30 mA., while the voltage of the third supply is varied by an external control knob. Will you please tell me how this should be connected to the "Record III"?

S. St. G. C.

This set is arranged for a single input H.T. voltage, and it will be quite in order to ignore the 120-volt and 0-100-volt terminals of your eliminator. You should join the high-tension leads from the set to the negative and "power" terminals of the eliminator.

We have assumed that the receiver is

constructed exactly as described, with a potentiometer for regulating screening grid voltage; it may be pointed out that if this controlling device is included in your eliminator the set itself may be simplified in an obvious manner by taking this supply direct from the "0-100" terminal of the eliminator. If this modification is introduced, a decoupling resistance must be inserted in the screening grid circuit, in place of the fixed element of the existing potentiometer.

o o o o

**The Southern Railway Again.**

On several occasions I have tried my "Everyman Portable" receiver in a train, but have found that reception is generally marred by cracklings and other noises. Does this suggest that the set is at fault, or, if the effect is normal, can it be overcome?

H. D.

This form of interference is well known, and is due to the electric lighting installations of the train. It is particularly likely to be troublesome with a receiver having a regenerative detector without H.F. amplification, and we fear that there is no simple cure. You must try to choose a train with gas lighting!

**FOREIGN BROADCAST GUIDE.****WARSAW  
(Poland).**

Geographical position: 52° 14' N. 21° 7' E.  
Approximate air line from London: 900 miles.

Wavelength: 1,411 m. Kilocycles: 212.5. Power: 8 kW.

Time: Central European (one hour in advance of G.M.T.)

**Standard Daily Transmissions.**

09.15 Sundays Sacred Service from Posen Cathedral; 10.58 Fanfare from Cracow; 18.58 daily Time signal (q.v.); 18.20 Tuesdays relay of performance from Kattowitz or Posen Opera Houses; 19.15 main evening programme; 22.00 Fridays relays of foreign stations; dance music Sundays, Mondays, Wednesdays and Saturdays.

Man and Woman announcers. Call (phonetic): *Hallo! Hallo! Polskie Raadjo Varschava.*

Announcements are made in the Polish language, but when International concerts are broadcast, also in English, French and German.

Interval signal: the letter W in morse (-.-).

Time signal: At 6.58 p.m. G.M.T. one long hoot, seven dashes, followed by:

..... the last dot indicating the full hour 7 p.m. G.M.T.

Frequently closes down with the Polish National Anthem (*Dombrowski Mazurka*).

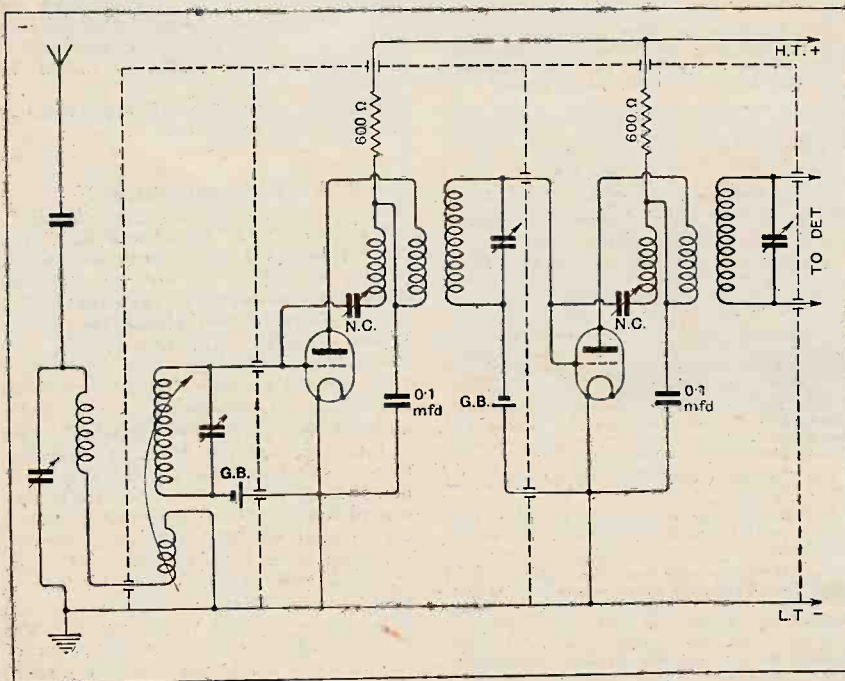
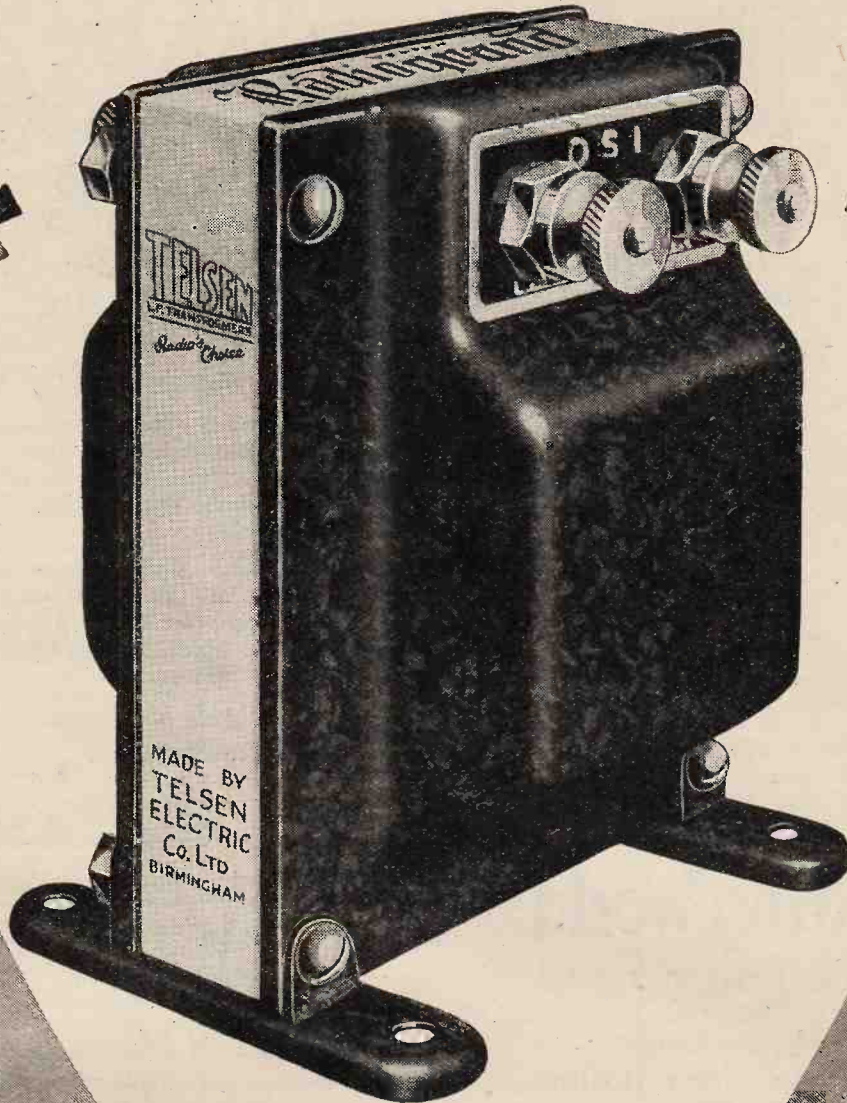

Fig. 2.—An amplification of more than 1,000 times can be attained with two neutralised H.F. stages and three-electrode valves.

**RADIOGRAND  
12'6**

**ACE  
8'6**



**FOLLOW THE LEAD OF THE  
SET MANUFACTURER**

# TELSEN

## TRANSFORMERS

**TELSEN ELECTRIC Co. Ltd., MILLER STREET, BIRMINGHAM.**

London Distributors: The Sel-Ezi Wireless Supply Co., Greek St., Soho, W.1

The Telsens  
Radio Grand  
Transformer  
illustrated  
herein is the  
outcome of an  
outstanding  
endeavour to  
place upon the  
market a trans-  
former at a  
former price,  
strictly com-  
petitive with  
yet possessing  
equal qualities  
to the most  
expensive in-  
strument.

General effi-  
ciency is un-  
varying with  
high or low in-  
put valves;  
special care has  
been exercised  
regarding the  
windings, the  
primary, both  
secondary, and  
capacity, the  
being compara-  
tively losses  
negligible. Your set  
will work better  
with a Telsens  
Transformer.—  
Fit one now.

# PHOTOGRAMS OF THE YEAR



THE ANNUAL REVIEW FOR 1930 OF THE WORLD'S PICTORIAL PHOTOGRAPHIC WORK

Edited by F. J. MORTIMER, F.R.P.S.

Editor of "The Amateur Photographer and Cinematographer."

PRICES:  
Paper Covers 5/-  
Cloth Boards 7/6  
Postage 6<sup>d</sup>. extra.

This year's edition of "PHOTOGRAMS OF THE YEAR" is now on sale, and lovers of pictures made by the camera will give it a warm welcome.

"PHOTOGRAMS" contains reproductions of the most striking and representative pictures from the principal photographic exhibitions of the year, selected from the work of the leading pictorial photographers of the world.

A literary section provides reports of photographic progress at home and overseas, and a useful Directory of British Photographic Societies is included.

For keen photographers the annual volume of "PHOTOGRAMS" is an inspiration; for those to whom camera pictures appeal it is a book which gives lasting pleasure.

From all leading booksellers or direct from the Publishers:

ILIFFE & SONS LTD., Dorset House, Tudor Street, London, E.C.4.

## The Yachting World and Motor Boating Journal

Covers Every Aspect of Yachting and Motor Boating  
FOUNDED 1894

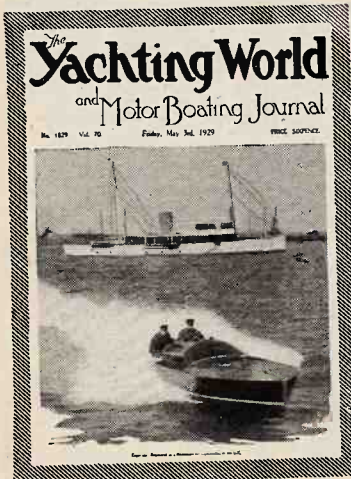

All who are interested in power-craft, whether cruisers, speed-boats or outboards, will enjoy reading "THE YACHTING WORLD and MOTOR BOATING JOURNAL."

It is a well-produced and attractive paper dealing with yachts and boats of all types and tonnages on sea and inland waters.

Racing, cruising, deep-sea sailing, practical seamanship and the construction of small craft are among the chief subjects of interest.

SUBSCRIPTIONS: Home and Canada, £1. 10. 4, other countries abroad £1. 12. 6, per annum, post free.

Every Friday 6<sup>d</sup>.

ILIFFE & SONS LTD., Dorset House, Tudor Street, London, E.C.4.

## DICTIONARY of WIRELESS TECHNICAL TERMS

Compiled by S. O. PEARSON, B.Sc., A.M.I.E.E., and issued in conjunction with "THE WIRELESS WORLD."

THIS volume contains definitions of terms and expressions commonly used in wireless telephony and telegraphy and is intended to serve as a guide to all those interested in wireless who come across, from time to time, unfamiliar words in their reading. In such cases the DICTIONARY OF WIRELESS TECHNICAL TERMS proves of very great use and value. It is well illustrated, and cross-referenced to enable the required information to be rapidly obtained.

PRICE 2/- NET

By Post 2/2

From leading Booksellers or direct from the Publishers:

ILIFFE & SONS LTD., Dorset House, Tudor Street, London, E.C.4. W.W.48

# MISCELLANEOUS ADVERTISEMENTS.

## NOTICES.

**THE CHARGE FOR ADVERTISEMENTS** in these columns is:

12 words or less, 2/- and 2d. for every additional word.

Each paragraph is charged separately and name and address must be counted.

**SERIES DISCOUNTS** are allowed to Trade Advertisers as follows on orders for consecutive insertions, provided a contract is placed in advance, and in the absence of fresh instructions the entire "copy" is repeated from the previous issue: 13 consecutive insertions 5%; 26 consecutive, 10%; 52 consecutive, 15%.

**ADVERTISEMENTS** for these columns are accepted up to **FIRST POST ON THURSDAY MORNING** (previous to date of issue) at the Head Offices of "The Wireless World," Dorset House, Tudor Street, London, E.C.4, or on **WEDNESDAY MORNING** at the Branch Offices 19, Hertford Street, Coventry; Guildhall Buildings, Navigation Street, Birmingham; 260, Deansgate, Manchester; 101, St. Vincent Street, Glasgow, C.2.

Advertisements that arrive too late for a particular issue will automatically be inserted in the following issue unless accompanied by instructions to the contrary. All advertisements in this section must be strictly prepaid.

The proprietors retain the right to refuse or withdraw advertisements at their discretion.

Postal Orders and Cheques sent in payment for advertisements should be made **& Co.** payable to **ILIFFE & SONS Ltd.**, and crossed **Notes** being **untraceable** if lost in transit should not be sent as remittances.

All letters relating to advertisements should quote the number which is printed at the end of each advertisement, and the date of the issue in which it appeared.

The proprietors are not responsible for clerical or printers' errors, although every care is taken to avoid mistakes.

### NUMBERED ADDRESSES.

For the convenience of private advertisers, letters may be addressed to numbers at "The Wireless World" Office. When this is desired, the sum of 6d. to defray the cost of registration and to cover postage on replies must be added to the advertisement charge, which must include the words Box 000, c/o "The Wireless World." Only the number will appear in the advertisement. All replies should be addressed No. 000, c/o "The Wireless World," Dorset House, Tudor Street, London, E.C.4. *Readers who reply to Box No. advertisements are warned against sending remittance through the post except in registered envelopes; in all such cases the use of the Deposit System is recommended, and the envelope should be clearly marked "Deposit Department."*

### DEPOSIT SYSTEM.

Readers who hesitate to send money to unknown persons may deal in perfect safety by availing themselves of our Deposit System. If the money be deposited with "The Wireless World," both parties are advised of its receipt.

The time allowed for decision is three days, counting from receipt of goods, after which period, if buyer decides not to retain goods, they must be returned to sender. If a sale is effected, buyer instructs us to remit amount to seller, but if not, seller instructs us to return amount to depositor. Carriage is paid by the buyer, but in the event of no sale, and subject to there being no different arrangement between buyer and seller, each pays carriage one way. The seller takes the risk of loss or damage in transit, for which we take no responsibility. For all transactions up to £10, a deposit fee of 1/- is charged; on transactions over £10 and under £50, the fee is 2/6; over £50, 5/-. All deposit matters are dealt with at Dorset House, Tudor Street, London, E.C.4, and cheques and money orders should be made payable to Iliffe & Sons Limited.

### THE SALE OF HOME-CONSTRUCTED UNLICENSED APPARATUS.

#### A Service to our Readers.

We have made an arrangement with the Patentees whereby readers who wish to dispose of a home-constructed receiver not licensed under the patents made use of, can license the set by means of the Deposit System referred to above.

The person desiring to sell, in sending us particulars for his advertisement, will in every case make use of a Box No., and should add to the price which he requires the amount of royalty customarily paid by manufacturers.

If the purchaser is satisfied with his purchase, the sum realised will be forwarded to the seller, less the amount due in respect of royalties, which amount will be paid by "The Wireless World" to the owners of the patents concerned, and a certificate will be handed on to the purchaser of the set.

**SPECIAL NOTE**—Readers who reply to advertisements and receive no answer to their enquiries are requested to regard the silence as an indication that the goods advertised have already been disposed of. Advertisers often receive so many enquiries that it is quite impossible to reply to each one by post.



## ALL WIRELESS WORLD COILS

1930 EVERYMAN FOUR	47/3 set
KIT SET, Coils with Switches	45/- set
NEW KILOMAG.	45/- set
RECORD III	45/- set
FOREIGN LISTENER; 4 B.B.C.	30/- set
	5XX 37/6 set
METAL CABINET	38/6 to 45/3
5 1/2" DRUM DIALS with Escutcheons	5/6
WAVETRAP; Litz Wire	10/8 each

## B&J. Wireless Co.

2, 3, & 4, Athelstan's Mews,  
Stroud Green Road, N.4.

Archway 1695

## MANUFACTURERS

Home or Abroad.

An active business, within a few minutes of Oxford Street, London, long connected with radio, now adopting a new policy, is prepared to handle a sole distributing agency, including advertising campaign, on terms by arrangement.

*Replies will be received in strict confidence to Box 4274*  
c/o "The Wireless World,"  
Dorset House, Tudor Street, London, E.C.4.

## ORDER YOUR CABINET

**NOW**

(Delivery from Stock)  
"The Wireless World"  
A. C. Kit Set

Metal Cabinet and Base Complete £2 15 0

**1930 EVERYMAN FOUR METAL CABINETS**

**46/6 each**

(or without woodwork 35/- each).

KILO-MAG & RECORD THREE METAL CABINETS.

35/- each, or with woodwork 46/6 each.

Kit-Set 27/6 and 38/6 each respectively.

Finished crystalline Brown, Black or Blue.

Trade enquiries invited.—Samuel Eaton & Sons (Manufacturers of Lighting Goods), 66/72, Barr St. Birmingham

## RECEIVERS FOR SALE.

**SCOTT SESSIONS** and Co., Great Britain's Radio Doctors.—Read advertisement under Miscellaneous. [0264]  
**3-VALVE** All-wave Receiver, latest type, powerful, perfect; £4.—V. Taylor, 57, Studley Rd., Stockwell, London. [0274]

**RECEIVERS** for Sale.—Portable 5-valve, suit case type, complete, as new, perfect; £9/17/6.—N. Taylor, 57, Studley Rd., Stockwell, London. [0323]

**G.E.C.** 7-valve Supersonic Portable Receiver, complete with valves, L.T. battery, and H.T. unit (A.C.), as new; reasonable offer accepted.—T. Bridger and Son, High St., Slough. [7710]

**MARCONIPHONE** Type 35 Screened Grid 3-valve Sets, brand new; £9, with valves; hire purchase arranged; only a few at this price.—Hall, 91, Fore St., Edmonton. [7722]

**GREAT Opportunity**.—Having many requests for famous Royal Air Force 3-valve receivers, we have now procured limited number; these receivers give excellent loud-speaker reception, each set specially tested before delivery to ensure satisfaction, all are guaranteed brand new and perfect; the original cost of these sets was £18; special travelling case with each set; we are sacrificing at the absurdly low price of 3/6.

**GUARANTEED** and Absolutely New McMichael Supersonic Kits, including mahogany cabinet, book instructions, blue prints; clearance price only £3; these sets can get the whole world; without cabinet, price £2.

**J. B. HUMPHREYS** and Co., 23, College Hill, Cannon St., London, E.C.4. [7718]

**SPLENDID** Western Electric Super Heterodyne 7-valve Wireless Set including frame aerial, 2-valve amplifier, high tension eliminator, and 3 loud-speakers; cost over £100, cash price £25 to quick buyer.—Thos. Lumb and Co., Ltd., Victoria Mills, Skipton. [7741]

**WIRELESS** Portable Sets, with 5 Cosmor new process valves, for 9 guineas; less than components cost, comparable with any set double this price, Royalty paid; seen between 1 and 2 p.m., or particulars sent on receipt of stamped addressed envelope.—G. Hodgson, 53, Windsor House, Victoria St., Westminster. [7737]

**PORTABLE** Igranic Neutrosone Seven, in black leatherette case, additional accumulator, and 1 pair of phones, perfect condition; cost £60; what offers?—R. Lewis, 14, St. James's Place, S.W. 1. [7730]

**McMICHAEL** Suit Case, cost £31, just overhauled, new valves; accept 10 guineas; perfect.—Gardener, 53, Alexandra Rd., Wimbledon. [7731]

**A** Complete Kit, including valves, not batteries, for 1929 Chummy Four, cameo case, aerial wound, offers over £9/10 wanted; also 2 Marconi S.610s, 35/-; Westinghouse H.T.5, 15/-; 2 Mullard Orgola coils, 12/6; all new and in perfect condition.—Box 4289, c/o The Wireless World. [7732]

**VERY** Slightly Shop Soiled but Carrying Makers' Guarantees:—3-valve receiver, £4/4; 2-valve receiver, £3/3; royalties paid; 7 days' approval against cash.—Bostock and Stonnill, 1, Westbourne Terrace, S.E.23. [7735]

**SIMMONDS BROS.**—Receivers constructed to your own or any published design; also repairs, reconstructions; and modernisations at moderate charges; best materials and workmanship guaranteed; numerous testimonials; quotations free.—Address, Shireland Rd., Smethwick. [5882]

**WE** Offer You the Following Inducements to Purchase Your New Receiver or Other Apparatus from us.

**FIRSTLY**.—Unbiased advice. The Principal of the firm has twenty years' professional wireless experience, having been at Government Experimental Stations in 1910. He has been Manager for the Sterling Telephone Co., radio expert to the G.E.C., and Chairman of the Technical Committee of the National Association of Radio Manufacturers. His advice has saved our clients many thousands of pounds, for, as everybody knows, there is no hobby on which more money is wasted on useless apparatus by the uninitiated.

**SECONDLY**.—We take your old apparatus in part exchange for new. Send us a list of your old apparatus, or, better still, send us the apparatus, and state your new requirement. We will then make our offer for your goods, and if you do not approve, which is unlikely, we will return the parcel, carriage paid.

**IF** You are in Doubt as to the Make of Receiver or other Apparatus you should purchase, write to us, and we will advise you; we have no leaning towards any particular maker, and will tell you the particular instrument you should buy for your purpose.

**SCIENTIFIC DEVELOPMENT** Co., 51, Fishergate, Preston. Tel.: 1364. [0226]

**ACCUMULATOR HIRE.**

**D**ON'T Buy Accumulators or Dry Batteries, join our C.A.V. low- and high-tension-accumulator hire service, the largest and best in London; better and cheaper reception with no trouble; regular deliveries within 12 miles of Charing Cross; no deposit, payment on delivery or by subscription; over 10,000 satisfied users; explanatory folder post free; phone or write to-day.—Radio Service (London), Ltd., 105, Torriono Av., N.W.5. Phone: North 0623-4-5. [7596]

**C**D.E.S. Accumulator Hire and Maintenance Service (5 mile radius).—98, Cherry Orchard Rd., Croydon. [6374]

**BATTERIES.**

**W**ET H.T. Replacements.—Sacs (capped or uncapped), highest grade, No. 1, 10d. per doz.; No. 2, 1/9 per doz.—See below.

**Z**INCS.—Best quality (wired), No. 1, 8d. per doz.; No. 2, 9d. per doz.; orders valued 5/- carriage paid, otherwise 6d. for postage.—British Battery Co., Clarendon Rd., Watford, Herts. [0258]

**P**ENTODE Users.—Write for details of new size self-charging wet battery; 20,000 milliamps, 6d. per volt; illustrated catalogue giving data, post free.—U. Taylor, 57, Studley Rd., Stockwell, London. [0273]

**W**ET H.T. Batteries.—Parts per dozen, jars, No. 1, 2 1/2 x 1 1/2 square, 1/3; No. 2, 1/6; zincs, No. 1, 10d.; No. 2, 11d.; sacs, No. 1, 1 1/2 dozen; No. 2, 1/9; terminals, 8d., 10d.; dozen cells (18 volts), complete with bands and electrolyte, No. 1, 4/1; No. 2, 5/-; post 9d.; high efficiency, long life, self charging, upkeep small; send 6d. for sample unit; illustrated booklet free, carriage free orders 10/-; write for free list wireless bargains, trade supplied.—W. Taylor, 57, Studley Rd., Stockwell, London. [0039]

**CHARGERS AND ELIMINATORS.**

**V**ORTEXION Transformers, chokes, etc., wound to any specification; write or phone for quotation; best quality components only.—Vortexion, 72, Merton Rd., Wimbledon, S.W.19. Tel.: Wimbledon 2814. [0319]

**A**TLAS Eliminators, D.O. £1/17/6, A.C. £3/17/6; Nesper triode chargers, 29/6. Phone: Gerrard 6268 for demonstration.—Greatrex and Co., 184, Regent St., London. [6451]

**T**ANTALUM and Liumium for A.C. Rectifiers; make up your own inexpensive chargers; blue prints for H.T. and L.T. 1/- each; Liumium electrodes fitted with terminals, 2-3 amps. and 5-8 amps.—Blackwell's Metallurgical Works, Ltd., Speke Rd. Works, Garston, Liverpool. Phone: Garston 980 (2 lines). [6282]

**P**HILIPSON'S Safety High Tension Battery Eliminators.

**10/-** Down and the Balance in Easy Monthly payments secures the finest high tension supply available.

**P**HILIPSON'S Safety Eliminators are Guaranteed for 12 Months.

**P**HILIPSON'S Safety Eliminators are the Cheapest to Install and the Cheapest to Run; prices: Model A.C.5 £4/17/6, A.C.7 £3/17/6, complete with full wave rectifiers; D.C.4 37/6, D.C.5 45/-.

**A**LL Models Obtained for 10/- Deposit; take advantage of this and get constant high tension immediately.

**W**RITE for Our Booklet, "Radio Power" to Philipson and Co., Ltd., Radio Engineers, Astley Bridge, Bolton. Phone: 2038. Grams: Safety, Bolton. Est. over 50 years. [0318]

**C**HERROS.—Cheros for all types of transformers and chokes, high grade instruments at a very moderate price; enquiries invited.—Chester Bros., 244, Dalston Lane, London, E.8. [5290]

**T**RANSFORMERS and Chokes for Battery Eliminators and for all wireless purposes, receiving or transmitting; enquiries invited.—Chester Bros., 244, Dalston Lane, London, E.8. [7587]

**S**AVAGE'S Specialise in Wireless Power from the Mains, reliable apparatus at reasonable prices.

**S**AVAGE'S Transformer Laminations and Bakelite Bobbins; intending home constructors should write for list.

**S**AVAGE'S Reliable Smoothing Condensers.—1,000 volts D.C. test, 2 mid. 3/-, 4 mid. 5/3; 500 volts D.C. test, 1 mid. 1/6, 2 mid. 2/3, 4 mid. 3/9.

**S**AVAGE'S Super Smoothing and Output Chokes.—Many types available, write for list.

**S**AVAGE'S Mains Transformer for Westinghouse Rectifiers.—H.T.4, 18/6; A3, 17/-; A4, 20/-.

**S**AVAGE'S Mains Transformer for Westinghouse H.T.4 Unit, with additional winding, 4 volts 3 amps; 23/-.

**S**AVAGE'S Mains Transformer.—V.T.31, 200-0-200 volts 60 m.amps., 2+2 volts 2 amps., 2+2 volts 3 amps.; 28/-.

**S**AVAGE'S Mains Transformer.—B.T.3 500-0-500 volts 120 m.amps., 3.75+3.75 volts 3 amps., 3+3 volts 3 amps., 2+2 volts 3 amps.; 51/-.

**S**AVAGE'S Mains Transformers and Power Chokes are carefully and individually constructed from first class materials with an exceptionally generous margin of safety.

**S**AVAGE'S, 146, Bishopsgate, London, E.C.2. Phone: Bishopsgate 6998. [6808]

**BE A MAINS CONSTRUCTOR**

A new and fascinating development for the radio home constructor is provided by building mains units and receivers. It is important that only the best components are used and thoroughly reliable units employed. Full information sent on application to us, or supplied by your radio dealer.

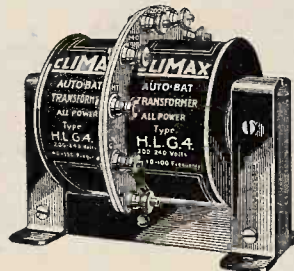

Climax Auto-bat Transformer Type H.L.G.4— for H.T., L.T. and G.B. supply, when using metal rectifiers and indirectly heated mains valves. A first class product with first class performance at a popular price - - - 32/6

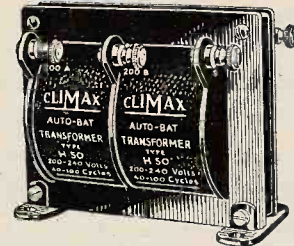

Climax Auto-bat Transformer Type H.50— for H.T. supply units using metal rectifier. Output up to 180 volts, and up to 50 milliamperes. Remarkable value. Price 17/6



The Climax capital Choke forms an extremely efficient smoothing choke for eliminating the ripple in H.T. supply for A.C. or D.C. mains. Winding resistance 500 ohms. Current carrying capacity 50 milliamperes. Inductance 12-20 henries. Price - - - 8/-



Climax Potential Divider for voltage tapplings in mains receivers and units. Ten Tappings. Wire wound. Bakelite bobbin. The most popular mains component yet designed. Price 5/-

**CLIMAX A YEAR AHEAD**

Ask your Dealer for our new leaflet "The Mains Constructor."

**CLIMAX RADIO ELECTRIC, LIMITED**

Haverstock Works, Parkhill Road, Hampstead, London, N.W.3.

Telephone: Primrose 1171-2.

**Chargers and Eliminators.—Contd.**

**F**EL-ECTRIC High Tension Eliminator Kits, improved output 15 milliamps at 120 volts; complete; 25/-.

**F**EL-ECTRIC Eliminator Kits are the Best and cheapest in England; complete, 25/-.

**F**EL-ECTRIC Kits are Complete, except valve, and we recommend Philips 373; 15/-.

**F**EL-ECTRIC Kits have been Sold in Hundreds, and are guaranteed, satisfaction or money returned.

**F**EL-ECTRIC Kit will be sent e.o.d. if desired, state voltage and periods, also whether Philips valve is required at 15/- extra.

**F**EL-ECTRIC Eliminator Kit is Post Free; price 25/-.

**F**OLDER and Lists on Request to Fel-Ectric Radio, 56, Garden St., Sheffield. [7742]

**CABINETS.**

**A**RTCRAFT Radio Cabinets are Britain's Best Value. [0313]

**D**IGBY'S Cabinets.—Table models in solid oak and mahogany; from 11/6 to 71/-.

**D**IGBY'S Cabinets, fitted with Radion or Resiston ebonite if required.

**D**IGBY'S Cabinets.—Pedestal model, with separate battery components; from 56/- to £12.

**D**IGBY'S Cabinets Made to Customer's Own Designs.

**D**IGBY'S Cabinets.—Write for new 16-page art catalogue.—F. Digby, 9, The Oval, Hackney Rd., E.2. Phone: Bishopsgate 6458. [0128]

**A**RTCRAFT Radio Cabinets; Britain's best value; lowest prices consistent with highest quality; illustrated list free from actual manufacturers.—Artcraft Co., 156, Cherry Orchard Rd., Croydon. Phone: Croydon 1981. [0040]

**C**ABINETS, 16 1/2 in. x 7 1/2 in. x 11 in., hand mahogany finished 7/6, unpolished 5/6; oval front, 10 1/2 in. x 6 1/2 in., 6d. extra; portable cabinets, 16 1/2 in. x 16 1/2 in. x 8 in., £1/5; baseboard, 6d.; carriage free.—F. W. Ramsey, 65, Shaftesbury St., London, N.1. Clerkenwell 7139. [7584]

**A**RTCRAFT Radio Cabinets are Britain's Best Value. [0309]

**K**AY'S Cabinets, the greatest range of pedestal cabinets in the kingdom; original creative designs at prices 50% lower than elsewhere; quotations for specials by return; delivery at short notice guaranteed; moving coil, portable, baffle, vignette, radiogram, electric pick-up, television, etc.; illustrated lists free. H. Kay, Wireless Cabinet Manufacturer, Mount Pleasant Rd., London, N.17. Phone: Watlington 1626. [7745]

**A**RTCRAFT Radio Cabinets are Britain's Best Value. [0311]

**F**INEST American Types, astonishing value, special offer oak cabinets, hinged lid, baseboard, highly polished, take 12 in. x 6 in. panel; sample, carriage paid, 6/6; trade discounts for quantities.—Mag-Radio, 112, Warstone Lane, Birmingham. [2665]

**A**RTCRAFT Radio Cabinets are Britain's Best Value. [0310]

**L**OU-D-SPEAKER Cabinets, extraordinary offer, oak cabinets, handsome fret front, highly polished, 13 in. square, 6 in. deep, finished moulding, take all ordinary units; sample, carriage paid, 6/6; trade discounts for quantities.—Mag-Radio, 112, Warstone Lane, Birmingham. [2666]

**COILS, TRANSFORMERS, ETC.**

**600-OHM** Decoupling Resistances for New Kilo-mag Four, foreign listeners' four, and all "Wireless World" circuits, hand made and tested in our own workshops; improved model wound with Constantan wire, 1/6 each, post free.—Groves Bros., St. Mary's Place, Shrewsbury. [7361]

**1,000-OHM** Decoupling Resistances for "Wireless World" Circuits; 1/6 each, post free.—Groves Bros., St. Mary's Place, Shrewsbury. [7362]

**M**ARCONIPHONE Ideal Junior Transformers, formerly 18/- clearing at 12/6; Marconiphone Popular transformers, formerly 12/6, clearing at 9/6; both post free; guaranteed new, in makers' original boxes.—Hall.

**M**ARCONIPHONE Power Transformer, 200-240v., gives 150 H.T. at 30m.a. with U5 valve and 4v. A.C. up to 8 amps.; formerly 37/6, clearing at 18/9; all new, in original boxes.—F. J. A. Hall, 91, Fore St., Edmonton, N.18. [7721]

**W**IRE-WOUND Non-inductive Resistances of all sizes, guaranteed, 600 and 1,000 ohms, 1/3; 25,000 ohms, 2/6, etc.; H.F. chokes, ebonite formers, silk covered, wire-wound, guaranteed 2,000 turns, 2/6 binocular type, 4/6.—Omnivox Products, 20, Brooke St., Holborn, E.C.1. [7727]

**N**EW Kilo-Mag Four Coils, 37/6 set; ebonite formers (slotted), for winding, 12/6 set of 3; all post free; trade supplied.—Groves Bros., St. Mary's Place, Shrewsbury. [7750]

Mention of "The Wireless World," when writing to advertisers, will ensure prompt attention.



Convert your present Set into a Short Wave Receiver.



**Magnum Short Wave Convertor.**

This Convertor is adaptable to any valve set by simply removing the detector valve from set and inserting it in the valveholder of convertor, the plug of convertor taking the place of the detector valve. In crystalline metal cabinet, with 2 Coils 20/40 and 40/80 metres, Plug and Adaptor £4.10.9 inclusive.



**Universal Three 15-2,000 metres.**

The most perfect receiver yet designed for Ultra Short Wave, Broadcast, and Long Wave reception. Including Valves, Coils and Royalty £18 : 0 : 0.

Magnum Receivers are now obtainable on Easy Payment Terms.

We specialise in all apparatus described in "Wireless World."

Lists on application.

**BURNE-JONES & Co., LTD.**

296, BOROUGH HIGH ST., LONDON, S.E.1.

**SEND 2d. POSTAGE FOR OUR NEW 56 PAGE FULLY ILLUSTRATED CATALOGUE**

**A.F. BULGIN & Co.**  
RADIO MANUFACTURERS  
9-10-11 CURSITOR ST. LONDON, E.C.4

**Coils, Transformers, Etc.—Contd.**

**SIMMONDS BROS.**—Berclit coils. Record Three, 50/- pair; new kilo-mag. four, 50/- set; foreign listeners four, low, 30/-; long wave, 37/-; screened grid Regional, 40/-; Mullard S.G.P. dual range coils, 30/- pair; Berclit standard coils, for new all-wave four, standard four, A.C. three, Everman four, etc. £3/6 set of 4, with bases; the same coils for the Lodestone series ("Wireless Magazine"), 65/9 set of 4, with bases; Titan unit, 15/-; decoupling resistances, 600 ohm, 1/6; 1,000 ohm, 2/-; all "Wireless World" and similar coils in regular production by the leading specialists; lists free; trade supplied.—Simmonds Bros., Shireland Rd., Smethwick. Tel.: Smethwick 751. [6314]

**GRAMOPHONE PICK-UPS, ETC.**

**ELECTRIC** Pick-up, with arm, adaptable to any gramophone; pick-up 14/-, arm 7/-; c.o.d.; remarkable value.—G. Hodgson, 53, Windsor House, Victoria St., Westminster. [7738]

**GRAMOPHONE Amplifier, Hypermu, Ferranti** push-pull, including valves; 70/-.—Potter, 2, St. Aidan's Rd., S.E.22. [7752]

**TRANSMITTERS.**

**CHEBROS.** Chebros. Chebros transformers and chokes of all descriptions, special transformers for transmitting and modulation; chokes a speciality; enquiries invited.—Chester Bros., 244, Dalston Lane, London, E.8. [5240]

**VALVES.**

**AMPLIFIER Valve.**—If you require power you cannot do better than one of these—

**FILAMENT** Volts 6, plate volts 400 (maximum), grid bias 84 volts (approx.), impedance 800 ohms, amplification factor 3.5, mutual conductance 4.35 m.2/volts; price £5/10; see article "The Wireless World," 24th July, 1929, then send to North London Valve Co., Ltd., 22½, Cazenove Rd., Stoke Newington, London, N.16. [7702]

**MULLARD** 4v. Pentode, little used; 15/-.—Wearing, "Ingledene," Leasowe Rd., Wallasey. [7728]

**LOUD-SPEAKERS.**

**6-VOLT** ½-amp. M.C. Speaker; list £6 new this year; 29/6; 7 days approval against cash.—Brew, Pychley, Kettering. [7708]

**MARCONIPHONE** Popular Horn Loud-speakers, adjustable unit, dark mahogany crystalline finish, absolutely new, in makers' original sealed boxes; formerly 42/-, clearance price 15/- each, postage 1/-.—F. J. A. Hall, 91, Fore St., Edmonton, N.18. [7720]

**BARGAIN.**—Mellovox; £1/5, cost double.—Box 4306, c/o The Wireless World. [7739]

**NEW B.T.H.** C2, 35/-; Amplion A.R.9, 27/-; Amplion A.R.19, 25/-; Amplion A.R.65, 25/-; A.R.19 and A.R.65 horns slightly damaged.—Box 4287, c/o The Wireless World. [7726]

**MARCONIPHONE** Moving Coil Speaker; cost £6/6, new condition, £3/10, or reasonable offer.—Snaith, 428, Finchley Rd., London, N.W.2. [7747]

**50** Different Makes of Loud-speakers in Stock; your old one taken in part payment, high allowances made; your enquiry will receive prompt attention.—Bostock and Stonnill, 1, Westbourne Terrace, S.E.23. [7734]

**R.K.** Loud-speaker, complete with Marconi 2-valve power amplifier for 230v. mains, which supplies field coil and gives H.T. supply for receiver, complete with spare L.S. 5a valve; £10 only.—Tracy, Red House Works, Winscombe. [7753]

**GREAT Bargains.**

**GREAT Bargains.**

**GREAT Bargains.**—Epoch model A moving coil speaker kit (or complete units), brand new; a large number of these famous instruments made for a special order for use in talkies, but not executed, for credit reasons only; regular prices, £3/10, £4/2, and £5/17/6, to clear at 50/- for accumulator operation, 55/- for D.C. mains operation, 85/- for A.C. mains; kits comprising copper plated super magnet-pot (weight 23 lb.) Crystalline frame, fully adjustable, moving coil, any impedance, paper, leather and mounting rings, made up complete, if desired, 6/- extra.

**GREAT Bargains.**

**GREAT Bargains.**—In fact, the greatest bargains ever offered! A number of Epoch model A used kits at given away prices, guaranteed in perfect working order; early 1928 model, 35/-; latest model, 42/6; made up complete, if desired, 6/- extra.

**ENJOY** Marvellous Epoch Reproduction at Ridiculous Cost; don't wait until they are all gone, but secure one immediately by writing, phoning, telegraphing, or hurrying to Epoch, 3, Farringdon Av., E.C.4. [7077]

**MADE BY**

**BELLING-LEE**

**- your Guarantee**

Insulated—fire proof—engraved name on both parts—case of connection—ample contacts—excellent appearance—complete safety for any set.



The first plug and socket in which both parts are engraved and entirely insulated when connected or disconnected.

Plug and Socket, 9d.  
Panel Portion, 3d.  
Flex Portion, 6d.

Ask your dealer, or send to us, for Belling-Lee Handbook "Radio Connections."

Advert. of Belling & Lee, Ltd., Queensway Wks., Ponders End, Md.

**ROTOR-OHM**

**VOLUME CONTROLS**

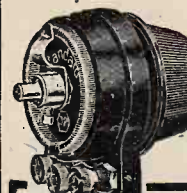

As a tone Control—Rotor-ohms will give you the finest quality of reproduction because they are—Durable, Constant, Accurate and as smooth as velvet in action.

If unable to obtain from your dealer, order direct from us—mentioning dealer's name and type required.

Ohms	Prices:
2,000, 5,000, 10,000,	(Standard Type) - 5/9
25,000, 50,000	(Potentiometer Type) - 6/6
70,000, 100,000,	
200,000, 500,000,	
1 Megohm, 2 Megohms	
7 Megohms	

**ROTOR ELECTRIC LTD.**  
(Dept. W.W.)

2-3, UPPER RATHBONE PLACE, LONDON, W.1  
Telephone: MUSEUM 2641-2642.

**"B.A.T." 750 Watt "Q.M.B." SWITCH.**

This miniature switch comfortably breaks 3 Amperes at 250 Volts. For H.F., L.F., H.T., L.T. Circuits. For A.C. Sets, Eliminators, Gramophones, and as Loud Speaker Field Switch, etc.

"WIRELESS WORLD" said (14.8.29) "functioned quite well on test and did not give any cause to justify doubt as to their ability to handle this wattage" (750 Watts!!). "Ideal for use in portable sets and in all types of mains equipment."

"B.A.T." "Q.M.B." POWER SWITCH only 2/6 Each.



**CLAUDE LYONS LTD., 76, OLDHALL STREET, LIVERPOOL.**

Loud-speakers.—Contd.

EPOCH Moving Coil Speakers.

EPOCH.

EPOCH.

EPOCH.

EPOCH.

EPOCH Moving Coil Speakers. Speak for Themselves.

EPOCH.

EPOCH.

EPOCH.

EPOCH.

EPOCH.—Test at Epoch against any other make. It will persuade you more than the best salesman.

EPOCH.

EPOCH.

EPOCH.

EPOCH.

EPOCH.—Ask any of the thousands of users of even the older models. But this season's models? Well, let the speakers tell you themselves.

EPOCH.

EPOCH.

EPOCH.

EPOCH.

EPOCH.—Please do test them against any or every make on the market—preferably with a quick switch over.

EPOCH.

EPOCH.

EPOCH.

EPOCH.

EPOCH.—Order one for 7 days' free trial.

EPOCH.

EPOCH.

EPOCH.

EPOCH.

EPOCH.—Your deposit instantly refunded in full if you are not more than satisfied. No catch. No red tape.

EPOCH.

EPOCH.

EPOCH.

EPOCH.—The most comprehensive range of moving coil speakers in the world.

EPOCH.

EPOCH.

EPOCH.

EPOCH.—Send for catalogue W.S.2.

EPOCH.

EPOCH.

EPOCH.

EPOCH.—16 pages crammed full of real information. Post free.

EPOCH.

EPOCH.

EPOCH.

EPOCH.

EPOCH RADIO MANUFACTURING Co., Ltd., are the manufacturers. City Office and Service Station, 3, Farringdon Avenue (Ludgate Circus end), E.C.4. Phone: Central 1971 (2 lines). Private Branch Exchange. [7754

# DOMINION VERNIER DIALS



## 2/6

Only Brownie's ability to produce 2,000 Dominion Vernier Dials a day enables them to keep the price as low as 2/6. The special non-backlash design (for fine tuning) and the splendid finish (smooth black or beautifully grained mahogany bakelite) coupled with the low price, makes the Dominion Vernier Dial a real radio bargain.

BROWNIE WIRELESS COMPANY (G.B.) LIMITED, NELSON STREET WORKS, LONDON, N.W.1

# BROWNIE WIRELESS

## None BETTER None CHEAPER

# TRIX FIXED CONDENSERS

As used in the Two Valve Set described in last week's "Wireless World." Real ruby mica insulation and genuine COPPER foil are just two features that have helped their success. The capacity being clearly engraved on case prevents mistakes occurring. Look for the Brown moulded case in the Blue and Orange Carton. Positively none better or cheaper than TRIX!

PRICE FROM  
**1/-** EACH

ERIC J. LEVER  
(TRIX) LTD.,  
87,  
Clerkenwell  
Green,  
London, E.C.1.  
Phone:  
Clerkenwell  
3014/5.

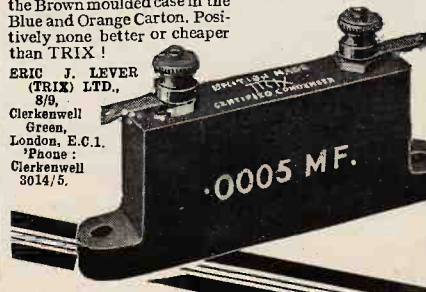

Loud-speakers.—Contd.

BAKER'S

SELHURST RADIO Moving Coil Speakers are of the Highest Grade and Proved Efficiency.

BAKER'S

SELHURST RADIO Moving Coil Speakers Obtained on 14 Days' Approval for Comparative Test.

BAKER'S

SELHURST RADIO Moving Coil Speakers Used by Music Lovers Throughout the World.

BAKER'S

SELHURST RADIO Moving Coil Speakers.—Write now for new 36-page booklet, "Sound Advice."

BAKER'S

SELHURST RADIO Moving Coil Speakers Reproduce both Speech and Music with Wonderful Realism.

BAKER'S

SELHURST RADIO Moving Coil Speakers can Always be Heard at the New Demonstration Room.

BAKER'S

SELHURST RADIO Moving Coil Speakers.—The new 36-page booklet is full of truthful information.

BAKER'S

SELHURST RADIO Moving Coil Speakers are the Best that Money can Buy; ideal New Year presents.

BAKER'S

SELHURST RADIO, the leading manufacturers of high grade coil speakers.

OFFICE: 89, Selhurst Rd., South Norwood, S.E.25.  
Phone: Croydon 1618. Works and Demonstration Room (always open): 42, Cherry Orchard Rd., East Croydon (15 minutes non-stop Victoria or London Bridge). [0231

Mention of "The Wireless World," when writing to advertisers, will ensure prompt attention.

—a tone-perfect production  
—a friend of good Records!



Scientifically designed, beautifully made, The MELTROPE Sound Box gives perfect tone and wonderful service, and will bring the oldest gramophone up to date!

Price **12/6.**

Made by  
**AMPLIFIERS LTD.,**  
BILLET ROAD, LONDON, E.17.

Suitable for all types of tone arm.

You Want an  
**"ELECTRADIX" RADIO TESTER**  
To Get Exact Results.

The  
**DIX-ONEMETER**  
is the Highest Grade possible Used in Admiralty, L.C.C. G.P.O., and the 'Varsities. Price: "DIX-ONEMETER," IN CASE, READING 40 MICROAMPS. PER DIV. WITH 6 MULTIPLIERS



**£4 : 10 : 0**

A Wonderful Stock of Radio and Scientific Apparatus.

Send us your Inquiries for Moving Coil Speakers, Mains Sets, Chokes, Gramo-motors and Amplifiers, Microphones, Recorders, Relays, Special Apparatus for Transmission and Testing, Dynamos and Motors, all sizes. Bridges, Galvos, Switch and Control Gear of every description in stock.

NOW READY, NEW EDITION OF 72 PAGE ILLUSTRATED CATALOGUE, 4d.

Send Stamped Addressed Envelope for November Sale List.

**218 Upper Thames Street, London, E.C.4**  
Telephone: City 0191

**"Build your own Dry Batteries."**  
A New Wireless Hobby.

We supply super capacity Dry Cells and all parts for build up your own dry battery at home.

This is the best and cheapest form of H.T. yet offered.

Super Capacity Cells, each 1.5 volts 22 millamps, 3/8 per doz. Send 1/4d. stamp for Booklet, "How to Build a Dry Battery at Home," to—

**THE LEYTON BATTERY CO., 305, Church Rd., Leyton, E.10.**

**COMPONENTS, ETC., FOR SALE.**

**BELLING-LEE** Panel Fittings are designed to give an expert finish to any home-constructed set; catalogue post free.—Belling and Lee, Ltd., Queenswar Works, Ponders End, Middlesex. [0018]

**POWER** Chokes, substantially built, for smoothing circuits in eliminators dealing with currents 100-300 milliamperes, inductance 30 henries; 8/6 each; guaranteed 12 months.—Transformer Repair Co. (Dept. W), 214, High St., Colliers Wood, S.W.19. [0327]

**WESTON** Model 301, milliammeters, ammeters, and voltmeters, 21/- each; hot wire ammeters 0-1 amps, 4/-; 0-0.5 amp., 3/-; instrument repairs and alterations; send for list.—The Victoria Electrical Co., 47, High St., Battersea, S.W.11. Established 1910. [7563]

**POTENTIAL** Dividers 10,000, 15,000, 20,000, 25,000 and 30,000 ohms, 5 variable tappings; 2/- each.

**POTENTIAL** Dividers, heavy duty, wire wound, 15,000 and 20,000 ohms, 7 tappings, 5/6; 4 tappings, 3/9.

**CONDENSERS**, 2 mfd., 2/3; 4 mfd., 4/-; guaranteed; tested 500 volts.

**CHOKES** (L.F.).—Excellent for smoothing, up to 2 milliamps, 2/-; special heavy duty, 10 milliamps, 8/6.

**ELIMINATORS**, A.C. wired for half or full wave, complete with valve; £3/17/6.

**H.F.** Chokes; 3/-.

**GRAMOPHONE** Motors, well known make, double spring, silent, complete with fittings; 30/-.

**SPECIAL Bargain**.—B.T.H. 40 henry chokes; 9/6; any article on approval against cash.—Huggins, Radio Engineer, Clacton-on-Sea. [7398]

**RADIO HOUSE, HUDDERSFIELD** (16th Winner).

**E**NLARGES

**L**ISTENERS'

**I**NTEREST

**A**ND

**B**BETTER

**F**IMPARTS

**L**UCID

**I**NFORMATION

**T**O

**YOU**.—A Littlehampton customer, through satisfaction, sent an unsolicited testimonial: "Your firm is 'streets ahead' of some of the London houses for business." This unsolicited reputation we endeavour to uphold.

**W**IRELESS

**I**NSTRUMENTS,

**R**EQUISITES,

**E**T.C.,

**L**ISTED,

**E**NТИРЕLY

**S**UPER

**S**ERVICE Provided and a Super Attractive Competition Provided, so try submitting similarly composed advertisement, using the words "Reliability Wireless Guide," so as to encourage readers to apply for this list. Weekly change of matter desired. A 100-volt H.T. battery for each effort published, and useful consolation prizes given.

**G**IVING

**U**NEXCELLED

**I**MPARTIAL

**D**EALINGS

**EVERYWHERE**.—So send for a guide, which will be sent to you post free by J. H. Taylor and Co., 15, Radio House, Macaulay St., Huddersfield, to whom competition efforts should be submitted, indicating also if name and address publishable if successful. (Only 23 alternative words required Radio House, Huddersfield, remaining, one word for each initial following.)—Prize-winner, Mr. Phillips, Bolton Wood. [7748]

Our 1930 Super Power Model.



"THE MUSIC LOVER'S CHOICE."

Radio - Gramophone music and speech reproduced with amazing and uncanny realism. The most efficient speaker money can buy.

**BAKER'S Selhurst RADIO**

SEND TO-DAY FOR OUR FREE 36-PAGE BOOKLET "SOUND ADVICE."

Office: 89 SELHURST ROAD, SOUTH NORWOOD, S.E.25.  
Works and Demonstration Room:  
42 CHERRY ORCHARD ROAD, EAST CROYDON.

These Cabinets are made by experts and are thoroughly electrically sealed with Fine Brass Gauze.



W.W. as specified CABINETS.  
**RIGBY & WOOLFENDEN,**  
Sheet Metal Workers,  
Milnrow Road, ROCHDALE. Phone 2948.

**ELEX** 2DH

2DS SPADES and PINS  
HOOKS and EYES  
6 Colours . . 2d. each.

2DP Write for List X91

2DI J. J. EASTICK & SONS,  
118 Bunhill Row, London, E.C.1.

**TILTRACK**  
Registered Trade Mark  
Patent-STEEL STORES-System

For the Wireless Experimenter, Factory, Factor and Retailer,  
Full Particulars from Sole Manufacturer and Patentee—  
**BERTRAM THOMAS,** Worsley Street, Hulme, MANCHESTER.

**REPAIRS**

Any make of L.F. Transformer, Loudspeaker or headphones repaired and dispatched within 48 HOURS—TWELVE MONTHS' GUARANTEE with each repair. 4/- Post Free.

Terms to Trade.

**TRANSFORMER REPAIR CO.,**  
Dept. W.  
214, High Street, Colliers Wood, London, S.W.19

**BERCLIF**  
"EVERYMAN FOUR" CONVERSION

L.W. COILS AND BASES . . . . . 34/6  
CONVERSION S.W. COILS . . . . . 10/6

Particulars and detail prices post free. TRADE SUPPLIED.

**SIMMONDS BROS.,**  
SHIRELAND ROAD, SMETHWICK.

**BONA FIDE TRADERS' GUIDE.**

Send for our comprehensive Illustrated List. QUICK SERVICE. QUICK SERVICE.

**THE QUALITY HOUSE.**

PERSEUS MFG. CO., LTD. (Dept. W.W.),  
BRANSTONE RD., BURTON-ON-TRENT.

**SUPER-MICROPHONES**

New, highly sensitive, made on the latest principle, a vast improvement over all other types; will pick up whispered words from a distance of several yards, also strongly amplify and transmit speech and music over a distance, through Loud-speaker or Headphones. **AMAZING VOLUME WITHOUT THE AID OF VALVES.** Splendid instruments for making Telephone Deaf-aid, **LOUD-SPEAKING TELEPHONE**, Announcements through Loud-speaker, Amplifier for Crystal or Valve Sets. Electric Sound Detector, Experiments.

**NO OTHER MICROPHONE OF EQUAL SENSITIVENESS KNOWN:** each instrument finely black enamelled and fitted with a 3 ft. silk connecting cord. Despatched by return post. **8/6**

**SPECIAL MICROPHONE TRANSFORMER** for connecting Super-Microphone to Radio Headphones, Loud-speaker, Valve Set, or Valve Amplifier **6/-**

**SMALL 10 OHMS EARPIECE** for use with Super-microphone as a **HIGHLY EFFICIENT DEAF-AID**, or Detectaphone, etc.; thin 3-ft. silk connecting cord fitted. Earpiece finely black enamelled. **6/-**  
Full Directions for use of Super-Microphone for many purposes and Diagrams of connections free.

**NEW PUBLIC ADDRESS MICROPHONE**

The Ideal Instrument for addressing an Audience through Loud-speaker (via Valve Amplifier or L.F. Stages of Wireless Set), and for relaying Speech and Musical Entertainment to any distance. Powerful Loud-speaker Reproduction with perfect Purity.

**Pedestal Type.** Highly Sensitive Microphone, guaranteed entirely free from distortion or microphonic noises, absolutely silent background; far superior to ordinary Microphone Transmitters; for use with Valve Amplifier or Valve Set (through leads of Gramophone Pick-up if desired) at Open-air Meetings, in Cinema, Theatre, or Concert Hall. Operates from 2 Volt tapping of L.T. Accumulator, through Microphone Transformer. Current consumption one-tenth Ampere. Provided with detachable Sound Collector and a 3ft. silk connecting cord, and fixed by rubber-rod suspension in nickel-plated stand 1 1/2 in. high; for mounting on Speaker's Platform, in Pulpit, on top of Camera Stand, or for suspension from ceiling, as illustration. **25/-**



**MICROPHONE WITHOUT STAND 16/-.**

The above Microphones are rendered Directional by attaching the Sound Collector.

Special Microphone Transformer for the above **6/-**.  
DIAGRAM OF CONNECTIONS FREE.  
**FREDK. ADOLPH, Actual Maker.** Phone: **MUSEUM 8329**  
27, Fitzroy Street, London, W.1.

Components, Etc., for Sale.—Contd.

**APPLEBY'S.**  
**THIS Opportunity We Take to Express to Several Thousands of Customers, following many callings, in this and distant countries all over the world, the old time greetings.**

**GOOD Wishes FOR the New Year.**

**FROM Those Who Constitute the Functioning of That Which You Know as Appleby's.**

**FROM, also, E St. J. Hetherington Appleby, London, N.W.1, N.W.10, and S.W.19.** [0316]

**YOUR Old Components Taken in Part Payment for Latest Type; see our advert in column Receivers for Sale.—Scientific Development Co., 51, Fishergate, Preston.** [0228]

**600-OHMS Decoupling Resistances; see advt. under Coils.—Groves Brothers, Manufacturers.** [7751]

**MISCELLANEOUS.**

**ALEXANDER BLACK.**  
**PLEASE Note New Address.**

**THE Original Wireless Doctor, will call (London and Home Counties) and cure your set.**

**CONSULTATIONS by Appointment Without Obligation, sets installed, maintained, and brought up to date, gramophone pick-ups, eliminators, and Webson moving coil speakers demonstrated; purity reproduction specialist.**

**55, Ebury St., Victoria, S.W.1. Sloane 1655.** [0277]

**EASY Payments.—We supply, by easy payments, components, accessories, and sets, any make; 10% down, balance spread over 10 months.—Send list of requirements to London Radio Supply Co., 11, Out Lane, London, E.C.2.** [0097]

**WIRELESS Notes.—A monthly service of information for all those who want the very best in wireless or gramophone reproduction; frank criticism of receivers and components; immediate postal help and advice in all difficulties; something new and unique; you must have it if you want to know the truth.—Full particulars free from Ernest H. Robinson, Langmead, Pirbright, Woking, Surrey.** [7607]

**SCOTT SESSIONS and Co., Great Britain's radio doctors, officially approved as wireless repairers by Radio Society of Great Britain and Wireless League; old sets of every type repaired, rebuilt, modernised; send set for immediate quotation.**

**SCOTT SESSIONS and Co.—New sets constructed with your or our components, guaranteed finest workmanship; we specialise in "The Wireless World" circuits; remember, we have satisfied customers throughout the British Isles and in three Continents; if you so desire, we will design and construct high grade apparatus to suit your special circumstances for quality, range and selectivity.—Tel.: Tudor 5326. Muswell Hill, London, N.10.** [0262]

**ENGINEERS.—Can't we get together? All we ask is the chance to prove that you can earn £300, £400, £500 per year and more. Other men are doing it, and you can do the same. We have an unrivalled and world-wide organisation waiting to help you, whether you be novice or expert. If you wish for something more than a bread-and-butter job you owe it to yourself to investigate our service. Our handbook, "Engineering Opportunities," has pointed the way to better things to over 20,000 of your fellows. It contains details of A.M.I.Mech.E., A.M.I.C.E., A.M.I.E.E., A.M.I.A.E., A.M.I.Struct.E., C. & G., G.P.O., etc., exams., and outlines home study courses in all branches of Electrical, Mechanical, Motor and Wireless Engineering. In a brilliant article Professor A. M. Low shows clearly the chances you are missing. The book and our advice are quite free. We guarantee No Pass—No Fee. Don't miss this opportunity; send a postcard—now (state branch, post or exam.)—British Institute of Engineering Technology, 87, Shakespeare House, 29, Oxford St., London, W.1.** [7640]

**IF You Live in London and are Interested in Any Receiver, loud-speaker, eliminator, etc., write, phone, or call, making an appointment for us to demonstrate the article in your own home; terms and exchanges arranged confidentially.—Bostock and Stonnill, 1, Westbourne Terrace, S.E.23. Sydenham 2236.** [7735]

**PATENT AGENTS.**

**PATENTS and Trade Marks, British and foreign.—Gee and Co. (H. T. P. Gee, Member R.S.G.B. and A.M.I.R.E.), 51-52, Chancery Lane, London, W.C.2. Phone: Holborn 1525.** [0001]

**The Best NEW YEAR RESOLUTION.**

**"I WILL ALWAYS USE**

**OBETA**

**BATTERIES."**

**STANDARD**  
60 Volt 8/- 105 Volt 13/6  
**POWER**  
60 Volt 10/3 105 Volt 16/6

Your Wireless Dealer can obtain them from:—

**F. L. LESINGHAM, 13, Victoria St., LONDON, S.W.1**

**BUILD WITH THIS COMPLETE CHASSIS**



Sold in all radio shops. If out of stock send dealer's name and address to us.

Ideal acoustic conditions for the natural reproduction of broadcast music, speech and song exclusive to factory-made Double Linen Diaphragm Speaker. Small diaphragm for high, large diaphragm for low audible frequencies. Accurately balanced for area, juxtaposition and mutual tension. Hear the chassis form at your dealer's. Available in four sizes from 42/-.

**ULTRA ELECTRIC LIMITED 661-663, Harrow Road, London, N.W.10**

**ULTRA AIR CHROME SPEAKER**

Baldry Ad. V131.

**THE GREAT DEMAND**

for C.D.M. components has compelled larger premises to be taken. When sending for goods, please note new address, to save delay.

**C.D.M. H.F. CHOKES, suitable on 15 to 2,000 metres, 5/- and 4/- each. MOTORBOATING STOPPER - 7/- each.**

**FIXED MICA CONDENSERS.**  
'00005 to '002 - 1/3 each.  
'0025 to '006 - 1/9 "  
'01 - 2/9 "

**C.D.M. DUONATOR.**  
'0003 and 2 meg. combined - 2/- each.

**WAVE TRAP - 7/6 each.**  
**REJECTOR - 8/6 "**

**RESISTORS, all prices upon application.**

**C. D. MELHUISE**

**NEW ADDRESS: MAXWELL WORKS, Conewood St., Highbury, London, N.5**

**PATENTS.**

**T**HE Proprietor of Patents Nos. 263752 and 263753. Variable Directional Electric Wave Generating Device and Directive Projecting and Receiving System for use in Wireless Telegraphy or Telephony, is desirous of entering into arrangements by way of licence or otherwise on reasonable terms for the purpose of exploiting the same and ensuring its full development and practical working in this country. All communications should be addressed in the first instance to J. E. Evans-Jackson and Company, Registered Patent Agents, Bath House, 57 to 60, Holborn Viaduct, London, E.C.1, and 34, Dame Street, Dublin, Ireland. [7712]

**REPAIRS.**

**T**WELVE Months' Guarantee Accompanies all our Repairs; any make of L.F. transformer, headphones, or loud-speaker repaired and despatched within 48 hours; 4/- post free; don't discard if burnt out; terms to trade.—Transformer Repair Co., (Dept. W.), 214, High St., Colliers Wood, S.W.19. [0011]

**S**COTT SESSIONS and Co., Great Britain's radio doctors; read advertisement under Miscellaneous column. [0263]

**K**INGSTON-ON-THAMES.—Transformers, 'phones, loud-speaker repairs; transformers wound to any ratio.—Minter, 156, Cambridge Rd. [7269]

**R**EPAIRS Returned Post Free, and to ensure satisfaction send remittance after approval of same.—Leeds Wireless Repair Service.

**L**OUND-SPEAKERS, headphones, rewound to any resistance and remagnetised. 3/-; transformers rewound, 4/-; Blue Spots, Triotrons and 4-pole units, 4/6; work guaranteed.—Leeds Wireless Repair Service, 5, Boston Place, Green Rd., Leeds. [7652]

**G**UARANTEED Repairs by Experts.—Loud-speakers, headphones, cone units, pick-ups, any type, rewound, remagnetised and adjusted; post free 4/-; transformers from 4/-.—Howell, 91, Morley Hill, Enfield, Middlesex. [7713]

**WANTED.**

**W**ANTED, Philips 4-valve short wave receiver, complete with valves and coils; must be cheap.—Full particulars to Occupier, 76, Foxhall Rd., Sherwood Rise, Nottingham. [7729]

**W**ANTED, Ferranti A.F.5 transformer.—Wild, 466, Footscray Rd., S.E.9. [7743]

**W**ANTED, Ferranti A.F.5 transformer; must be quite sound and cheap.—Offers to Box 4310, c/o *The Wireless World*. [7749]

**I**NDUCTION Gramophone Motor, M.O. speaker, 230v. A.C.—Anton House, Richings Way, Iver, Bucks. [7744]

**T**WO Pairs Formo True Scale Couplers, also 2 0.1 coupling condensers, for Phoenix V set; quickly.—Maxted, 71, Chaplin Rd., Stapleton Rd., Bristol. [7755]

**EXCHANGE.**

**W**E Will Accept Your Surplus Apparatus (making you a high allowance) in part payment for any new apparatus; your enquiry will be dealt with promptly.—Bostock and Stonnill, 1, Westbourne Terrace, S.E.23. [7736]

**Y**OUR Old Apparatus Taken in Part Payment for Latest Type; see our advert. in column Receivers for Sale.—Scientific Development Co., 51, Fishergate, Preston. [0230]

**AGENCIES.**

**A**GENTS Wanted, spare time, wireless experience, to demonstrate and sell the world's best and cheapest 3-valve set.—Mag-Radio, 112, Warstone Lane, Birmingham. [2667]

**SITUATIONS VACANT.**

**S**ITUATIONS Guaranteed as Wireless Operators, age 15-30, day-evening postal courses; boarding students' fee payable after situation found.—School, 321, Mansfield Rd., Nottingham. [7746]

**S**ERVICE Engineer Required for Hull and District, must have thorough technical knowledge and experience with mains operated receivers, eliminators, etc.—State age, experience and salary required by letter to The Edison Swan Electric Co., Ltd., Service and Installation Dept., 1a, Newman St., London, W.1. [7740]



**VOX VERITAS**

**3-CORNERED BAFFLE**

Board dimen.: 30" x 30", Oak 3/4" ply.  
Mahogany 3/4" ply.  
Centre opening 7 1/2" diameter.

"The Wireless World," Dec. 18th, says:  
"... a handsomely finished baffle."

This hand-polished baffle board is built with open sides and bottom which entirely eliminate box resonance. Removable top and rear leg folds flat against front.

Oak, Jacobean - - - - - **38/6**  
Mahogany, Queen Anne - - - - - **42/-**

Carriage forward.

**MOROGORO TRADING CORPN. LD.,**  
12, Union Court, Old Broad St., London, E.C.2.  
Phone: London Wall 8236.

**TANNOY**

**WHY NOT GET YOUR H.T. AND L.T. FROM THE MAINS?**

Specially designed—they are more reliable and absolutely "trouble-free" with minimum consumption. They cost less. For A.C. mains

H.T. from £2:17:6  
L.T. from £2:12:6  
Combined H.T. and L.T. from £5:12:6 (complete)

Bring your radio up to date  
**TULSEMERE MFG. CO.**  
1-7 Dalton Street, S.E.27  
Telephone: Streatham 6731

**Mains Units**

**BOOKS, INSTRUCTION, ETC.**

**W**ET H.T. Batteries are now a proved success; write for new illustrated booklet, giving cost and method of building and maintaining free; mention paper.—Taylor, 57, Studley Rd., Stockwell, London. [0077]

**S**TEP by Step Wireless; a complete course of the theory of electricity in relation to the practical design of wireless apparatus, eliminators, circuits, etc., with extracts from a designer's notebook, giving up-to-date practical application; issued weekly; send 1/- p.o. for first 4 weeks.—Clifford Pressland, A.M.I.E.E. Bur., Dept. W.W., Hampton-on-Thames. [0195]

**F**REE: Inventor's Guide on Patents.—T. A. A., 253 (W), Gray's Inn Rd., London, W.C.1. [6373]

**A**CCUMULATOR Charging, Maintenance and Repair. By W. S. Ibbetson. A handy guide to the charging and upkeep of accumulator for wireless work or motor cars; 3/6 net.—Of booksellers or Pitman's, Parker St., Kingsway, London, W.C.2. [7068]

**BATE'S MILLION** **1/6 EA.**  
A REAL EARTH TUBE  
EARTH TUBE 24" LONG X 1" DIA.  
ALL DEALERS SUPPLY.  
**JABEZ BATE & CO.**  
VERONA WORKS BIRMINGHAM

**EXACT TUNERS**  
250 to 2,000 metres.  
No further coils are required, tuning is as simple as A.B.C. see "Wireless World," January 25th.: "We can strongly recommend these tuners." Send postcard for particulars and Circuits FREE to  
**THE EXACT MANUFACTURING CO.**  
Croft Works, Priory Place, COVENTRY.

**POLAR CONDENSERS**  
GIVE BETTER TUNING.  
POLAR "IDEAL"  
·0005, 12/6. ·00035, 12/3.  
·0003, 12/-.  
Ask your Dealer for Polar.

**"It may interest you to know**

that my advertisement in 'The Wireless World' brought over 70 replies in three days, which is, I think, a wonderful testimony to the advertising efficiency of your paper."

J. MITCHELL,  
10, Hilton Avenue, Frizinghall, Bradford, Yorks.

Full particulars of advertising in the Classified Columns of "The Wireless World" are given on the first page of Miscellaneous Advertisements.

**INDEX TO ADVERTISEMENTS.**

	PAGE		PAGE		PAGE
Adolph, Fredk.	16	Eaton, S., & Sons	11	Philips Radio	17
Amplifiers, Ltd.	15	Electradix Radios	15	Player's	18
Appleby, E. Hetherington		Epoch Radio Manf. Co., Ltd.	17	Potter, H. B., & Co. Ltd.	18
B. & J. Wireless Co.	11	Exact Mfg. Co.	3	Radio Gramophone Development Co.	1
Baker's "Selhurst" Radio	15	Eyer Ready Co. (G.B.), Ltd.	3	Radio Instruments, Ltd.	15
Bate, Jabez, & Co.	17	Ferranti, Ltd.	3	Rigby & Woolfenden	2
Bayliss, W., Ltd.	13	Garnett, Whiteley & Co., Ltd.	3	Rothermel Corp., Ltd. (Electrad)	13
Belling & Lee, Ltd.	6	Grosvenor Battery Co., Ltd.	18	Rowley, Thomas A., Ltd.	4
Britannia Rubber & Kamptulicon Co., Ltd.	2	Hobbies, Ltd.	6	Rotor Electric, Ltd.	15
British Insulated Cables, Ltd.	18	Holzman, Ltd.	18	Scientific Supply Stores	4
British Institute of Eng. Tech.	14	Hughes, F. A., & Co., Ltd.	16	Squire, Fredk., Ltd.	15
Brownie Wireless Co. (G.B.), Ltd.	13	Jackson Bros.	16	Simmonds Bros.	15
Bulgin, A. F., & Co.	13	Lesingham, F. L.	14	Telegraph Condenser Co., Ltd.	Cover i. & 5
Bullphone, Ltd.	13	Lever, Eric J. (Trix), Ltd.	15	Telsen Electric Co., Ltd.	9
Burne-Jones & Co., Ltd.	13	Leyton Batt. Co.	15	Thomas, Bertram	15
Burton, C. F. & H.	5	London Electric Wire Co. & Smiths, Ltd.	7	Transformer Repair Co.	15
Celestion, Ltd.	Cover ii.	Lyons, Claude, Ltd.	13	Trelleborg Ebonite Works, Ltd.	6
Clarith Reproducers, Ltd.		Marconiphone Co., Ltd.	16	Tulsemere Manf. Co.	17
Climax Radio Electric, Ltd.	12	Melhuish, C. D.	16	Ultra Electric, Ltd.	16
Cole, E. K., Ltd.	Cover i.	M-I Magneto Synd., Ltd.	4	Varley (Oliver Pell Control, Ltd.)	2
Cossor, A. C., Ltd.	8	Morogoro Trading Corp., Ltd.	17	Watmel Wireless Co., Ltd.	Cover i.
Day, Will, Ltd.		Mullard Wireless Service Co., Ltd.	Cover i.	Westinghouse Brake & Saxby Signal Co., Ltd.	Cover iii.
Dubilier Condenser Co. (1925), Ltd.	ii. & 6	Ormond Engineering Co., Ltd.	Cover iv.	Wilkins & Wright, Ltd.	Cover i.
Eastick, J. J., & Sons	15	Partridge & Mee, Ltd.	15	Wingrove & Rogers, Ltd.	17
		Perseus Manf. Co.	15		

*It costs you only 10'6*



The home constructor can easily build this Speaker Cabinet for an outlay of 10/6. Sound mahogany boards and free construction chart and illustrated cutting instructions. Stands 18 1/2 ins. high and suitable for any cone, chassis and speaker unit. Reproduction and style equal to any four guinea model.

**FREE CHART.**

All details of construction with full size patterns given with this week's Hobbies Weekly, now on sale at any newsagent, price 2d. Or send 2d. in stamps for one to Dept. 16, Hobbies Ltd., Dereham, Norfolk.

**PARFAIT**  
THE PERFECT  
**EBONITE PANEL**  
ONE QUALITY ONLY  
— THE BEST —

SUPPLIED IN Matt Semi-Polished Mahogany Highly Polished Black  
SIX FINISHES Cube Surface Highly Polished Mahogany Semi-Polished Black.  
*Stocked by most Wireless dealers. If any difficulty in obtaining locally, write for name of nearest stockist to:*  
H. B. POTTER & Co., Ltd., Station Buildings, ROGHDALE.

**ENGINEERS!**



Can't we get together?

All we ask is the chance to prove that you can earn £300, £400, £500 per year or more. Other men are doing it, and you can do the same.

We have an unrivalled and world-wide organisation, waiting to help you whether you be novice or expert. If you wish for something more than a "bread and butter" job you owe it to yourself to investigate our Service.

Our handbook "Engineering Opportunities" has pointed the way to better things to over 20,000 of your fellows. It contains details of A.M.I.Mech.E., A.M.I.E.E., A.M.I.C.E., A.M.I.A.E., A.M.I.Struct.E., London Matric., C. & G., G.P.O., etc. Exams., outlines home study courses in all branches of Electrical, Mechanical, Motor and Wireless Engineering, and explains our unique guarantee of

**NO PASS—NO FEE.**

In a Brilliant Foreword Prof. A. M. Low shows clearly the chances you are missing.

"Engineering Opportunities" and our advice are quite FREE. Don't neglect this offer—give vent to that "upward urge" and send a postcard NOW, stating Branch, Post or Exam. which interests you.

**BRITISH INSTITUTE OF ENGINEERING TECHNOLOGY,**  
387, SHAKESPEARE HOUSE, 29-31, OXFORD STREET, W.1.

**MOTION PICTURES**

WITH THE

**BABY CINÉ**

By Harold B. Abbott

Issued in conjunction with  
THE  
AMATEUR  
PHOTOGRAPHER  
PRICE 2/6 NET

By post  
2/8

This Handbook has been specially written for amateur cinematographers, and deals with all the necessary operations from "taking" the picture to the developing and projection of the film. Amateur workers will find the volume full of practical information and useful suggestions.

"MOTION PICTURES" is addressed in particular to users of Baby Ciné outfits, but nearly all the information it contains is applicable to other apparatus.

From all booksellers or direct from the Publishers:

ILIFFE & SONS LTD.,  
Dorset House, Tudor St.,  
London, E.C.4

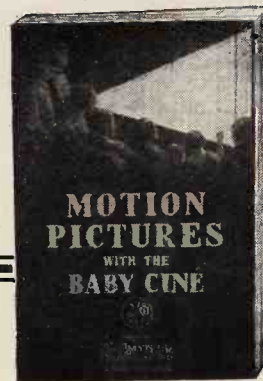

# A good resolution for 1930—

Make your set an "All-Mains" one.

THE



## METAL RECTIFIER

will help you by providing the simplest, most reliable and efficient means of converting the alternating current from your mains into direct current.

Our book "The All-Metal Way, 1930," contains 32 pages of information and instructions from which any kind of mains unit can be made. Send a 2d. stamp with your name and address to:—

The Westinghouse Brake & Saxby Signal Co., Ltd., 82, York Road, London, N.1.

## Don't go through 1930

without your copy of this useful little book!

The  
**Wireless**  
AND  
RADIO REVIEW **World**  
**DIARY**  
for 1930

Price 1/- net.

By post 1/1.

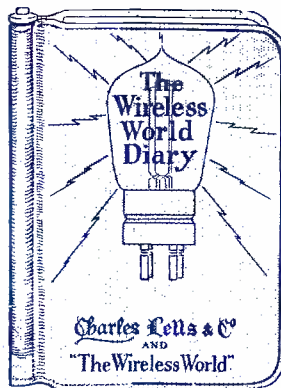

This little volume contains in convenient compass a mass of information which wireless users frequently require, and the Diary pages provide ample space for memoranda and notes concerning individual sets and other wireless matters.

From all Booksellers and Stationers.

Published jointly by  
"THE WIRELESS WORLD,"  
Dorset House, Tudor Street,  
LONDON, E.C.4.

AND  
**Charles Letts & Co**

In leather case, with pockets, pencil and season ticket window, 2/6 net. By post 2/7.

### PRINCIPAL CONTENTS :

Summary of Regulations Relating to Amateur Transmitter and Receiving Licences. Conversion Tables, English measures to metric and *vice versa*. Decimal and metrical equivalents of fractions of an inch. Broadcasting Stations of Europe with their Call-Signs and Wavelengths. Principal Short-

wave Broadcasting and Commercial Stations of the World. Nationality Prefixes used by Amateurs. Morse Code. Symbols used in Wireless Diagrams. Typical Wireless Receiver and Eliminators:—Fourteen Different Circuits with Diagrams. Valve Data, giving the characteristic features of standard valves.

Mention of "The Wireless World," when writing to advertisers, will ensure prompt attention.

FOR

# The ORMOND *De Luxe Model* LOUD SPEAKER

PUNCH

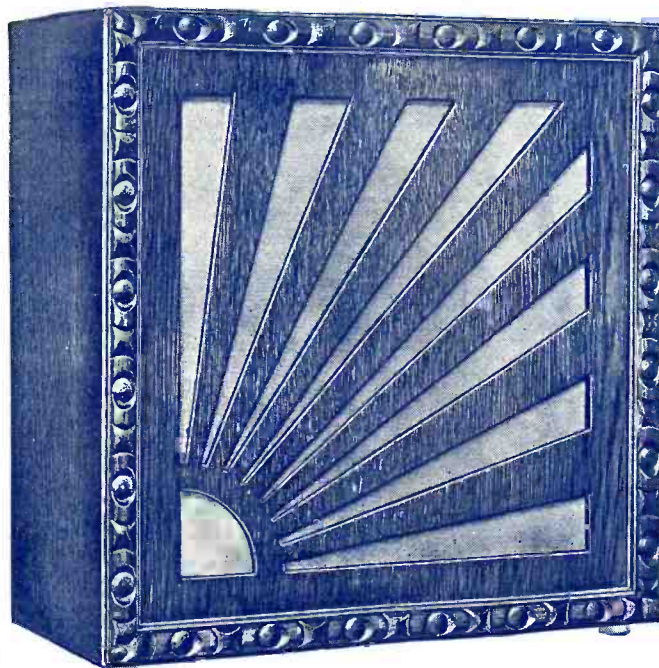

## Magnificent in Performance & Appearance

Price

# 50'

A loud speaker of superb tonal quality in a beautiful Cabinet. Scientifically designed to reproduce those overtones by which each instrument attains its individual characteristic tone.

Every note, vocal or instrumental, is produced with faithfulness and charm whilst there is no sign of reverberation when handling "Volume." Fitted with the Four-Pole Adjustable Unit with a convenient adjustment at the rear.

Most Certainly a speaker which will find favour with the most discriminating.

*Supplied in handsome Figured Oak or Mahogany Cabinet of most attractive design and superb finish. A loudspeaker unequalled for quality of performance and appearance.*



THE ORMOND ENGINEERING CO., LIMITED  
ORMOND HOUSE, ROSEBERY AVENUE, LONDON, E.C. 1.

'Phone: Clerkenwell 5334-5-6 & 9344-5-6.

Telegrams: "Ormondengi, Smith."

POWER

PURITY

Printed for the Publishers, LIFFE & SONS LTD., Dorset House, Tudor Street, London, E.C.4, by The Cornwall Press Ltd., Paris Garden, Stamford Street, London, S.E.1.

Colonial and Foreign Agents:  
UNITED STATES—The International News Co., 131, Varick Street, New York. FRANCE—W. H. Smith & Son, 248, Rue Rivoli, Paris; Hachette et Cie, Rue Réaumur, Paris.  
BELGIUM—W. H. Smith & Son, 78, Marche aux Herbes, Brussels. INDIA—A. H. Wheeler & Co., Bombay, Allahabad and Calcutta. SOUTH AFRICA—Central News Agency, Ltd.  
AUSTRALIA—Gordon & Gotch, Ltd., Melbourne (Victoria), Sydney (N.S.W.), Brisbane (Queensland), Adelaide (S.A.), Perth (W.A.), and Launceston (Tasmania).  
CANADA—The American News Co., Ltd., Toronto, Winnipeg, Vancouver, Montreal, Ottawa, St. John, Halifax, Hamilton; Gordon & Gotch, Ltd., Toronto; Imperial News Co., Toronto, Montreal, Winnipeg, Vancouver, Victoria. NEW ZEALAND—Gordon & Gotch, Ltd., Wellington. Auckland, Christchurch and Dunedin.



GRAMOPHONE SPEED TESTER

# The Wireless World

4<sup>D</sup>

AND  
RADIO REVIEW

*The Paper for Every Wireless Amateur*

Wednesday, January 8th, 1930.



RADIOGRAND  
12/6

**TELSEN**  
L.F. TRANSFORMERS

*Radio's Choice*

Have acquired a world-wide reputation for Quality and Value.

Built by Specialists in Transformer construction, they have set a Quality of Performance above reproach. Your Set will work better with a Telsen Transformer - - - Fit one now!

TELTEN ELECTRIC CO. LTD.,  
Miller Street, Birmingham.

750-WATTS!  
THE BEST SWITCH YET.

LYONS "B.A.T." (Best-After-Test) "QMB" SWITCH comfortably breaks 3 Amps. at 250 Volts, yet it is extremely small and very robust and unconditionally guaranteed.

Cordially reviewed by "W.W."—specified in the 1930 EVERYMAN FOUR, etc. Essential in 2-volt sets where switch resistance is fatal. Used by many leading set-makers.

USES:—

H.T. Units, A.C. Sets, L.T. Switch, for Portables, Gram-Motor Control, M/C Speaker Field Switch, etc. Super-sedes noisy "push-pull" varieties and clearly indicates "ON" or "OFF."

Nickel Finish.

Send for FREE 4-pp. Circular.



ONLY  
2/6

CLAUDE LYONS Ltd.,  
76, OLDHALL STREET, LIVERPOOL.

**HYDRA**  
CONDENSERS  
THE STRONG POINT  
IN ANY MAINS UNIT!

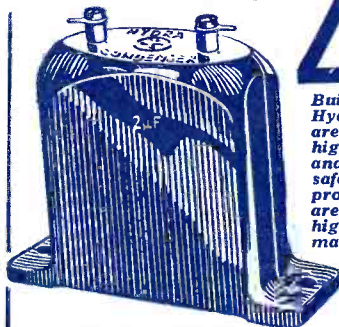

Build an eliminator with Hydra Condensers and you are putting between the high voltage of your mains and your set the surest safeguard that science can provide. Hydra Condensers are built to stand up to higher pressures than your mains supply—and every one is tested before it leaves the factory—tested far beyond its stated working voltage. Fit HYDRA for safety.

—LOUIS HOLZMAN, 37 Newman Street, London, W.1.

**BurTON**  
SELF-LOCATING  
VALVE  
HOLDER



1/- each

Pentode  
-Valve-  
Holders  
1/6 each

Patent No.  
316708

MANUFACTURED BY  
C. F. & H. BurTON

PROGRESS WORKS  
WALSALL, ENG.

# A PERFORMANCE of HIGHEST MERIT

The greatest assurance of "success" possible for an artiste to receive is the public's demand for "more" and "more."

## The McMICHAEL SUPER RANGE PORTABLE FOUR

is an assured success and the most popular Portable with discriminating people. Judged on its own merits in regard to quality of design and construction, or judged from a high standard of convenience, portability and performance, this receiver is without doubt supreme. Fitted in a beautifully finished furniture hide suitcase, with patent locking clips, with all accessories ready for immediate use, it possesses the following noteworthy features:—

1. Screened Grid Amplification.
2. Single dial tuning and volume control.
3. High selectivity.
4. Low upkeep cost.

Owing to the high degree of selectivity in this, and our other Screened Grid Portable Receivers, we are able to guarantee complete selectivity between all main B.B.C. Stations under the new scheme of wavelengths

Ask for a demonstration of this set at any high-class radio store, or call at our London Showrooms.

CASH PRICE

**22 GNS.**

(Including all Equipment and Royalties).

Or by our special "Deferred Payments on Hire Purchase Terms" system, £5 down and 10 monthly payments of £2 : 1 : 0



## The McMICHAEL SUPER RANGE FOUR (TABLE MODEL)

A handsome Walnut table model mounted on a turntable and with a self-contained frame aerial and earth. The McMichael Super Range Four (Table Model) offers the same perfection in performance as

the Portable model and contains an exactly similar circuit. This model is designed for home use where an outdoor aerial and earth are not convenient or desirable. An additional aerial and earth may be used, however, to add to the normal and truly remarkable range.

**CASH PRICE 26 GNS.**  
(Including all Equipment and Royalties).

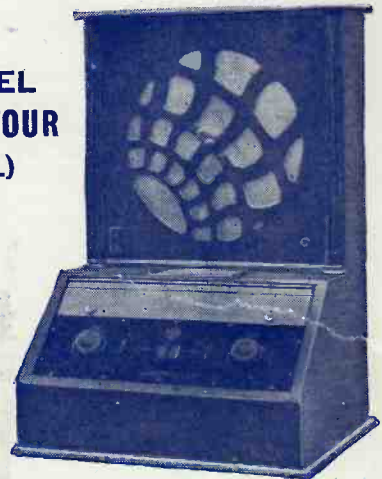

**L. M. MICHAEL LTD**

Manufacturers of Wireless and Scientific Apparatus  
**WEXHAM ROAD, SLOUGH, BUCKS.**

Telephone: SLOUGH 441-442. Telegrams: RADIETHER, SLOUGH.  
London Showrooms: 179, STRAND, W.C.2. (Telephone: Holborn 2466.)

Mention of "The Wireless World," when writing to advertisers, will ensure prompt attention.

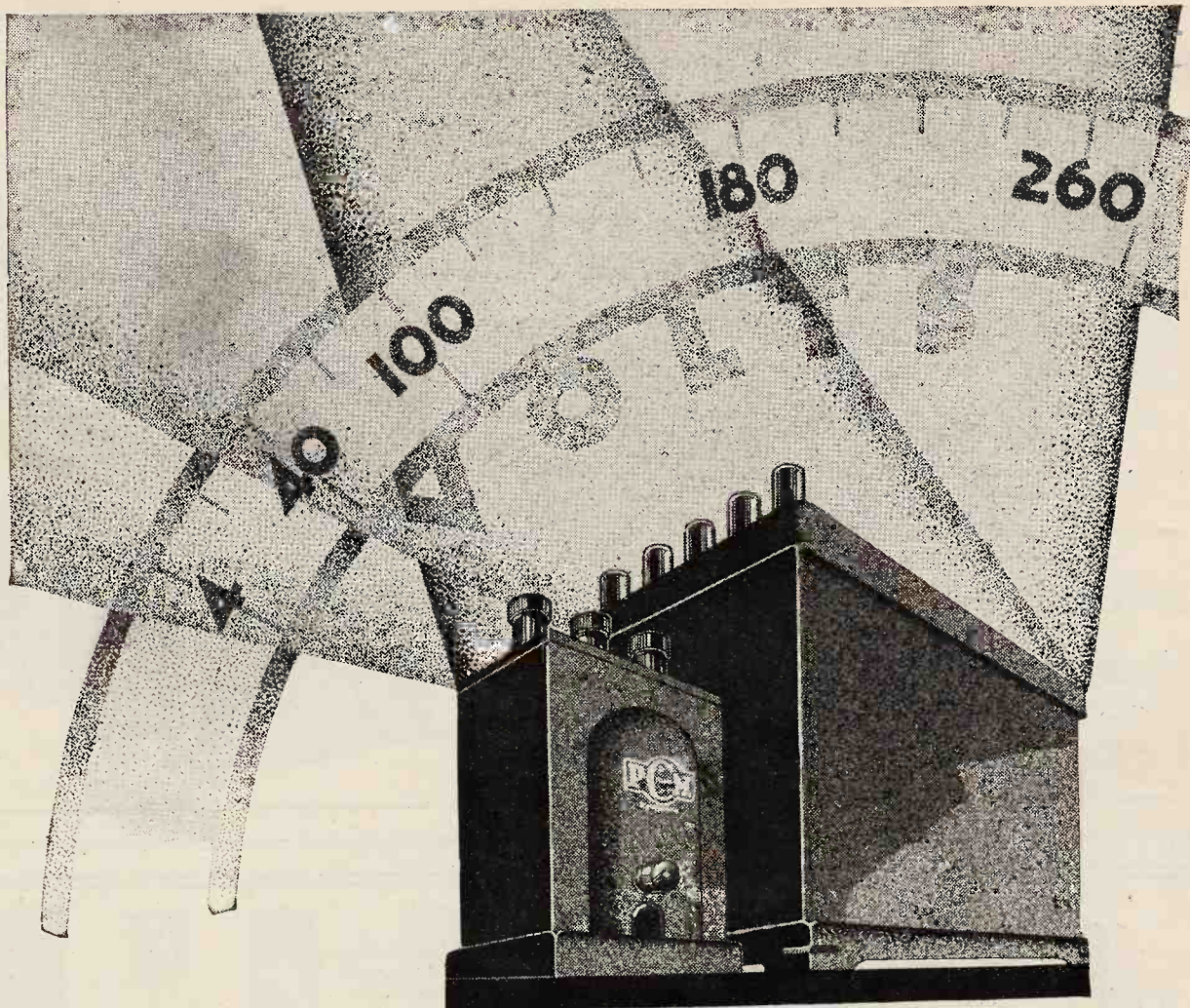

# RADIO ENERGY

USE them both—the A.C. Filament Transformer and the A.C. High Tension Unit. Mullard has made them for *your* radio, bringing you instant trouble-free entertainment with no hum. Too long have batteries held back radio from being effortless entertainment, but with the advent of these components you can fetter the steady energy of the mains to give you lasting service.

# Mullard MASTER · RADIO

### USEFUL INFORMATION.

#### A.C. Filament Heating Transformer. Output 4 v. 5 amp.

Type No.	103	111	210	222	240	253
A.C. Mains Voltage	100-106	107-114	200-214	215-228	229-245	246-260

Price 32/6.

Please give voltage and periodicity of A.C. Mains supply or type number when ordering.

#### H.T. Supply Unit.

Approximate output when used in conjunction with an average multivalve receiver.

Tapping	1—Detector Valves	40-60 v.
"	2—H.F. Valves	60-90 v.
"	3—L.F. Valves	90-130 v.
"	4—Last Valves	150 v.

Type No.	103	111	210	222	240	250
A.C. Mains Voltage	100-106	107-114	200-214	215-228	229-245	246-260

Price £5-5-0

Please give voltage and periodicity of A.C. Mains supply or type number when ordering.

Advert. The Mullard Wireless Service Co., Ltd., Mullard House, Charing Cross Road, London, W.C.2.

# Tudor

## HIT UNITS FOR MODERN SETS

For modern sets, with power valves, pentodes and moving coil loudspeakers, the Tudor Monobloc High Tension Unit has no superior.

It is a 10-volt Unit sold in three capacities, each more than ample for ordinary requirements, yet not too heavy to make awkward handling—a unit that will stand for months between charges without a drop in voltage, because of its absolutely non-current-leaking construction. It is a unit which has sold in thousands since its introduction, not one single unit having been returned because of unsatisfactory performance. A unit made by a company with 35 years' battery experience—whose huge stationary batteries, weighing hundreds of tons each, are used by the majority of power stations in this country.



M.C.45.

### ESTABLISHED IN PUBLIC SERVICE

### 10 VOLT HIGH TENSION UNITS.

**COUPON.**  
Please send me full particulars of Tudor Wireless Batteries.  
Name .....  
Address .....

Tudor Accumulator Co., Ltd., 2, Norfolk Street, Strand, London, W.C.2.

	Capacity.	Price.
5 H.T.1 ..	2,750 milliamps	6/9
5 H.T.2 ..	5,500 ..	10/-
5 H.T.4 ..	12,500 ..	17/6

Advt. of Tudor Accumulator Co., Ltd., 2, Norfolk Street, Strand, London, W.C.2.

# LISENIN

## POSITIVE GRIP TERMINALS

(Patented)

Scientifically constructed, both electrically and mechanically, they hold the wire, but grip the flex covering. All stresses and strains are removed from the conductors, and once a connection is made it stays put, and without any unsightly frayed ends of leads, the bane of all fans.

Write for **FREE** copy of our latest descriptive leaflet "W.W." Post free, of course.

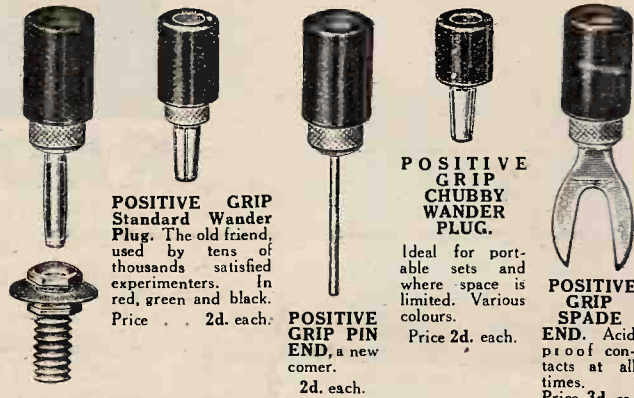

**POSITIVE GRIP Standard Wander Plug.** The old friend, used by tens of thousands satisfied experimenters. In red, green and black. Price .. 2d. each.

**POSITIVE GRIP CHUBBY WANDER PLUG.**

Ideal for portable sets and where space is limited. Various colours. Price 2d. each.

**POSITIVE GRIP PIN END,** a new comer. 2d. each.

**POSITIVE GRIP SPADE END.** Acid proof contacts at all times. Price 3d. ea.

**POSITIVE GRIP Banana Type PLUG & SOCKET.** A great advance on all other types of plug. A silky, dead smooth contact is NOW obtainable. Price 4d. complete.

**LISENIN POSITIVE GRIP ALL MAINS PLUG AND SOCKET** (Registered Design). The Lisenin Mains Plug and Socket is totally insulated and is equally as valuable on sets working off batteries as those from the electric supply. The leads may be dropped with impunity and there is no chance of a short circuit. Instantly assembled with the aid of a screwdriver. **NOTE THE PRICE, 6d. each, complete as illustrated.**

**WRITE to-day for our new descriptive folder, mentioning this paper.**

**POSITIVE GRIP SAFETY PLUG AND SOCKET** (Registered Design).



We have moved to larger premises. Note new address:—  
**THE LISENIN WIRELESS CO.,**  
5, Central Buildings, HIGH ST., SLOUGH, Bucks.  
Phone: Slough 652. T. Address: POSGRIP, SLOUGH.

Look for the Lisenin Show Case on your Radio Dealer's Counter.

Mention of "The Wireless World," when writing to advertisers, will ensure prompt attention.

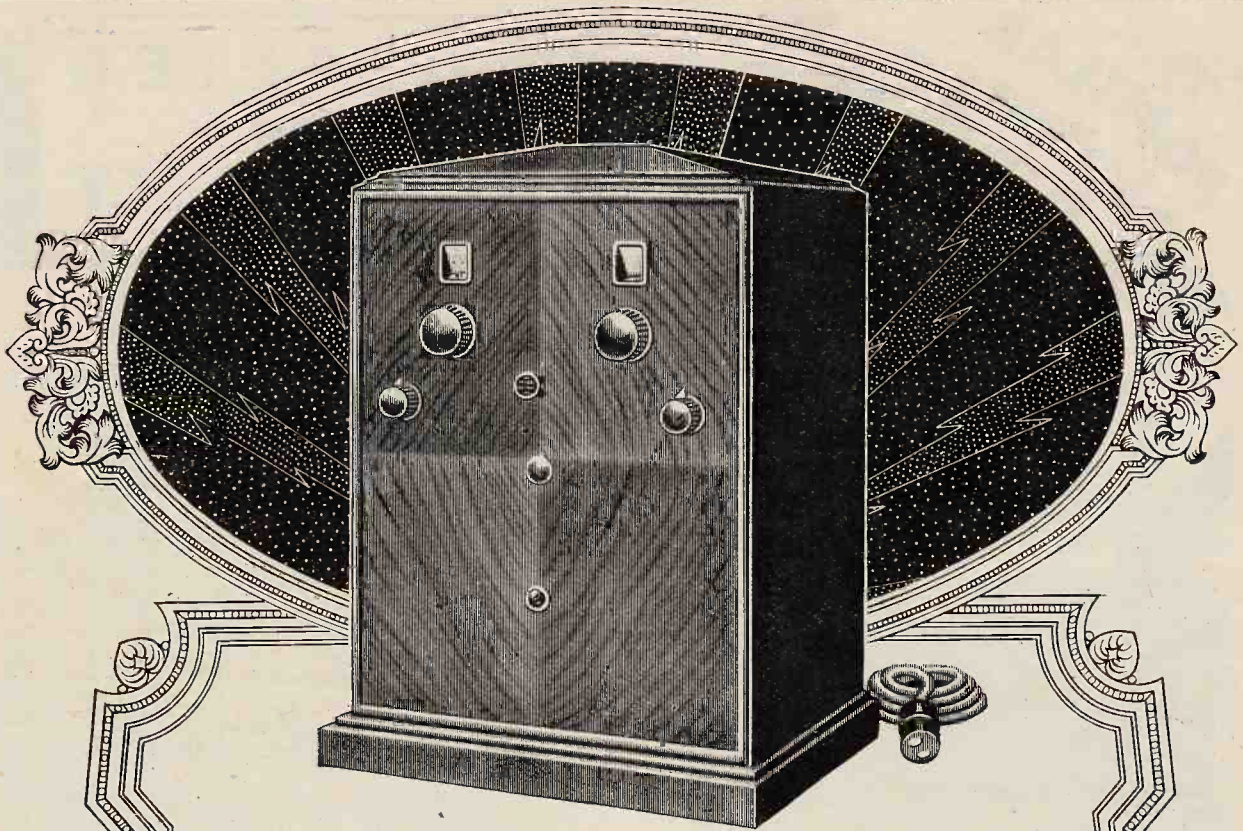

The outstanding feature of the FERRANTI A.C. Mains Receiver is the reproduction, which is very nearly true to life. The volume and richness of tone satisfy the critical listener.

This quality is attained by the use of the finest audio frequency components available and the close attention to detail which is expected from FERRANTI. Every component has been designed or chosen for the purpose it has to fulfil.

We have considered quality before price. Quality tells in the long run, and the first cost is the last cost when the best is bought.

The Set is handsome, too. You have the choice of three woods to tone with any scheme of furnishing.

Available for Alternating Current only, voltages 200 to 250; 50 cycles or over.

Any high-class dealer will demonstrate this Set to you and many will supply it on H.P. terms, if desired.

Price, including valves:

In Oak £25; In Mahogany £26; In Walnut £26

*Royalty £1 extra.*

# FERRANTI

## A.C. MAINS RECEIVER

FERRANTI LTD.

HOLLINWOOD

LANCASHIRE

FERRANTI

**THE POPULAR LOTUS ALL ELECTRIC RECEIVER for £19-9 DOWN**

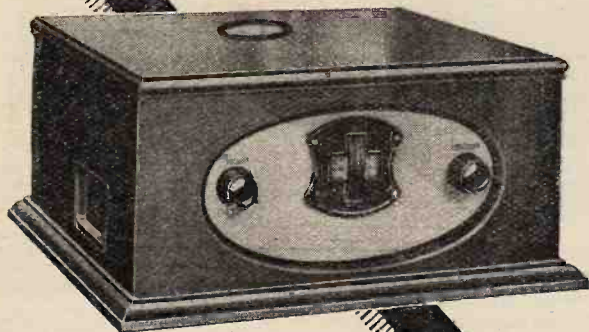

Go home and listen  
Radio Week 12th to 18th January

Easily operated by connecting to any A.C. Mains light socket—no batteries needed—this Lotus All Electric 3-valve S.G.P. Set is highly selective and covers a good range of British and Continental stations. Cash price £21 (Royalties paid, and including valves). The same circuit is used in the Lotus 3-valve S.G.P. Battery Model—Cash price £13:15:0.

For home construction get the Lotus 3-valve S.G.P. Battery Model Kit at £7:12:6. See and hear it at any wireless dealer's or write to-day for the Lotus Sets Catalogue and Hire Purchase terms.

**LOTUS ALL ELECTRIC RECEIVER**

*Gets the best reception.*

*Made by the makers of the famous Lotus components in one of the most modern radio factories in Great Britain.*

**GARNETT WHITELEY & CO., LTD., Dept. W.W.4,**  
Lotus Works, Mill Lane, Liverpool.

Co 510n

**DUBILIER FOR DURABILITY**

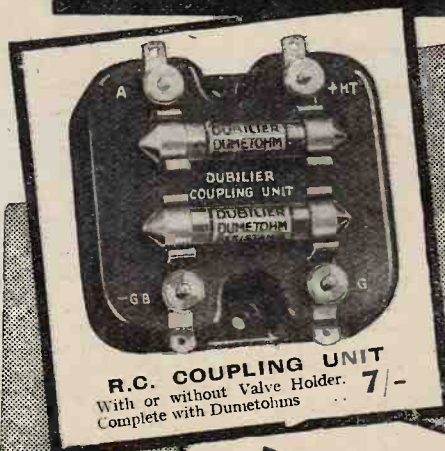

**R.C. COUPLING UNIT**  
With or without Valve Holder. 7/-  
Complete with Dumetohms



**DUCON AERIAL**  
Does away with outdoor aerial, as it has simply to be plugged into any standard electric lamp socket. Tested at 2,500 volts. Absolutely safe. 5/-



**H.F. CHOKE**  
Four types to meet all uses. All types 4/6

Ask your dealer for the Dubilier Booklet—"A Bit about a Battery"—it's free.  
If you have any difficulty in obtaining Dubilier products write direct giving the name and address of your dealer.

"Go Home and Listen."  
Radio Week, Jan. 12-18.

**DUBILIER RADIO PRODUCTS**

Dubilier Condenser Co. (1923) Ltd., Ducon Works, Victoria Road, North Acton, London, W.3

BC 250 C

Mention of "The Wireless World," when writing to advertisers, will ensure prompt attention.

A4

# For 1930 VARLEY ALL-ELECTRIC RECEIVERS

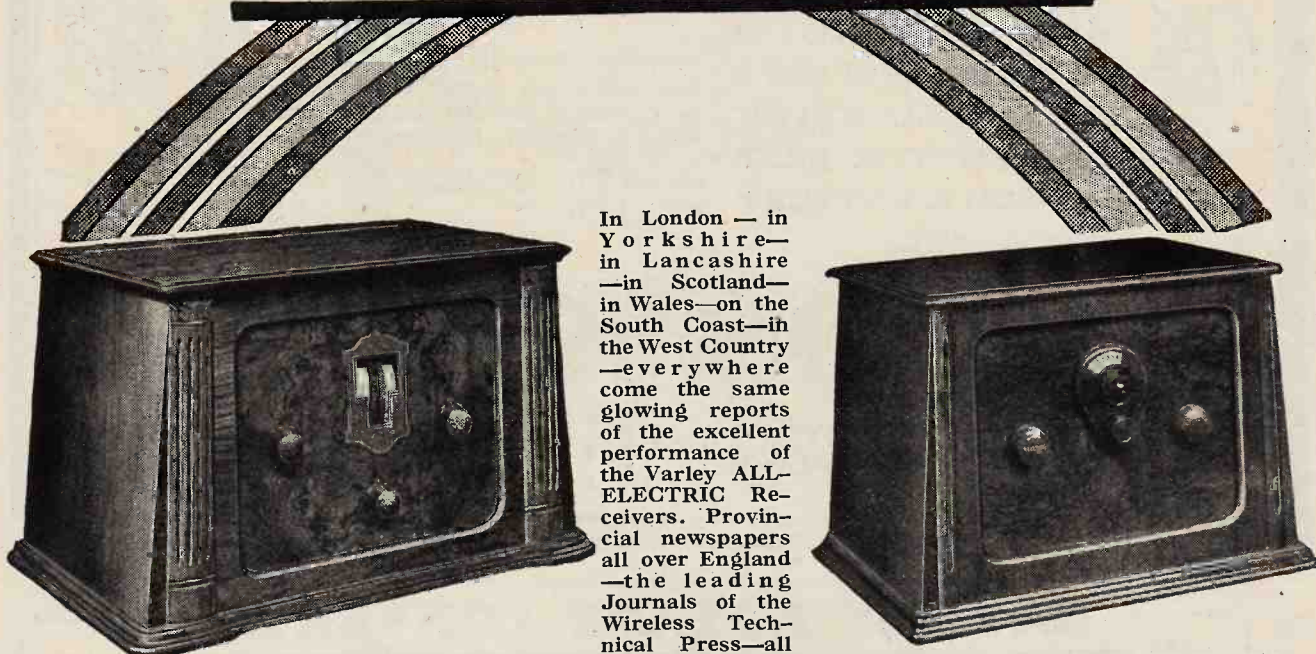

In London — in  
Yorkshire—  
in Lancashire  
—in Scotland—  
in Wales—on the  
South Coast—in  
the West Country  
—everywhere  
come the same  
glowing reports  
of the excellent  
performance of  
the Varley ALL-  
ELECTRIC Re-  
ceivers. Provin-  
cial newspapers  
all over England  
—the leading  
Journals of the  
Wireless Tech-  
nical Press—all

Varley All-Electric  
3-Valve Receivers  
List Nos. AP3  
(A.C.) and AP4  
(D.C.).

*Marconi Royalty extra, each 20s.*

recommend these Sets in the strongest terms.  
Behind them is the name VARLEY—the name that stands  
for everything up to date, for QUALITY, for all-round  
excellent performance, and for perfect finish.

Varley All-Electric  
2-Valve Receivers  
List Nos. AP1  
(A.C.) and AP2  
(D.C.).

*Marconi Royalty extra, each 15s*

25 Gns.

## and RADIO GRAMOPHONES

16 Gns.

Write to-day for Section A of our new Catalogue, which  
gives full particulars of Varley All-Electric Receivers and  
Radio Gramophones.



Radio Week, Jan. 12-18. A real pleasure  
if your Set is a Varley All-Electric.

Advertisement of Oliver Pell Control Ltd., Kingsway House, 103, Kingsway, London, W.C.2.

Telephone: Hoiborn 5303.

R.I. Advertisements for "The Wireless World" are only accepted from firms we believe to be thoroughly reliable.

# Radio's Supreme Power



ARE YOU PROUD  
OF YOUR NEW SET?  
DO IT JUSTICE  
AND FIT THE BEST  
POSSIBLE BATTERY

Grosvenor Batteries give continuous and satisfactory service because they incorporate a new vitalising element which is unique to Grosvenor.



66 v. from 7/6	Super Capacity for Multi-Valve Sets	66 v. 20/-
99 v. „ 11/6		99 v. 32/6

## The Grosvenor Battery

BRITISH MANUFACTURE

GROSVENOR BATTERY CO., LTD., 2-3, White St., MOORGATE, LONDON, E.C.2. Phone. Met. 6365

### BAYLISS ROTARY CONVERTER

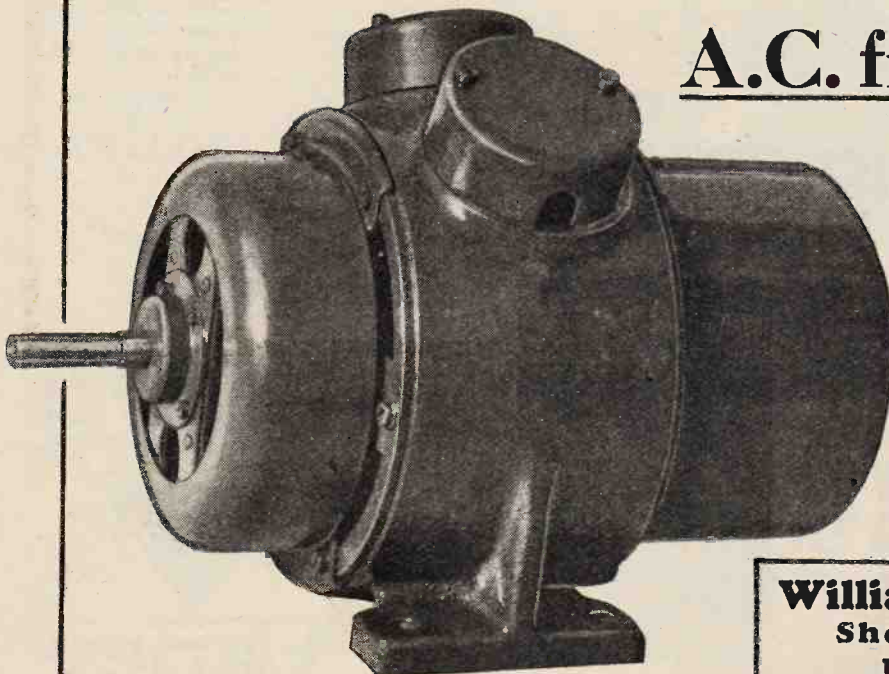

## A.C. from D.C.

Load 400 Watts.

ANY Input.  
ANY Output.

PRICE

£12 . 10 . 0

Delivery  
from Stock.

**William Bayliss Ltd.**  
Sheepcote Street  
**BIRMINGHAM**

Telephone :  
Mid 1409.

Telegrams :  
"Drawbench, B'ham."

Mention of "The Wireless World," when writing to advertisers, will ensure prompt attention.



K  
U  
K  
O  
O

*Tom Prendergast*

PROFESSIONAL "PERRUQUIER" TO THE PRINCIPAL  
LANCASHIRE AND YORKSHIRE AMATEUR OPERATIC  
AND DRAMATIC SOCIETIES

24, UPPER BROOK ST.,  
C.O.M.,  
MANCHESTER

Dec. 11th. 1929.

The Sheffield Magnet Co.,  
116/126, Broad Lane,  
Sheffield.

Gents,

In answer to yours of the 9/12/29,  
I beg to state that you are at liberty to  
make any use of the P.C. posted to you on  
Saturday last. Since writing you this,  
I have carefully gone over the "Mullard  
Master Three" set, and the 120 Volt H.  
Tension "Exide" Batteries, and in con-  
junction with your "KUKOO" Unit, I now  
get results that are really surprising  
and pleasing. I do get Moving Coil  
results and far sweeter than most M. Coils  
on the market. There is absolutely no  
trouble in fixing your Unit to a 36" Baffle  
Board as I use. With a Vellum (pure)  
Cone-- surrounded with a Chamois leather  
edging (Cone made shallow) I get wonderful  
reception. I intend making 2 more  
Loud Speakers.

Yours etc.,

*Tom Prendergast*

TOM PRENDERGAST  
24, UPPER BROOK ST. C.O.M. MANCHESTER  
PROFESSIONAL "PERRUQUIER" TO THE PRINCIPAL LANCASHIRE  
AND YORKSHIRE AMATEUR OPERATIC AND DRAMATIC SOCIETIES

7/12/29

Gents. I have fixed the  
"Kukoo" L.S. (Baffle Board 36")  
& have obtained absolutely  
Moving Coil results. Wonderful.  
Thanks. Yours etc.  
Prendergast

Postage 9d. extra



The **SUPER  
SPEAKER  
UNIT**

Sole Patentees & Manufacturers:—  
THE  
SHEFFIELD MAGNET CO.  
BROAD LANE, SHEFFIELD.

\*Phone:—20866.

\*Grams:—Magnet 20856 Sheffield.

Weight 2 lb. 2 ozs.

# FEATURES THAT MATTER

IT'S when you begin to look into J.B. Condensers that you appreciate the skill, the accuracy, the endless patience with which they are designed and made.



This is the Universal Log—one of the new models. It is the Condenser of the season, and has already featured in many of the Star Circuits. The frame construction is such that complete rigidity is assured.

**PRICES:**  
 .0005 - 9/6 .0003 - 9/-  
 .00025 - 8/9 .00015 - 8/9  
*Radio Week, Jan. 12-18*  
**J.B. Precision Condensers will ensure sharp, easy, accurate tuning.**

This bush is removable, enabling the Condenser to be fixed to Panel either end, left or right hand.

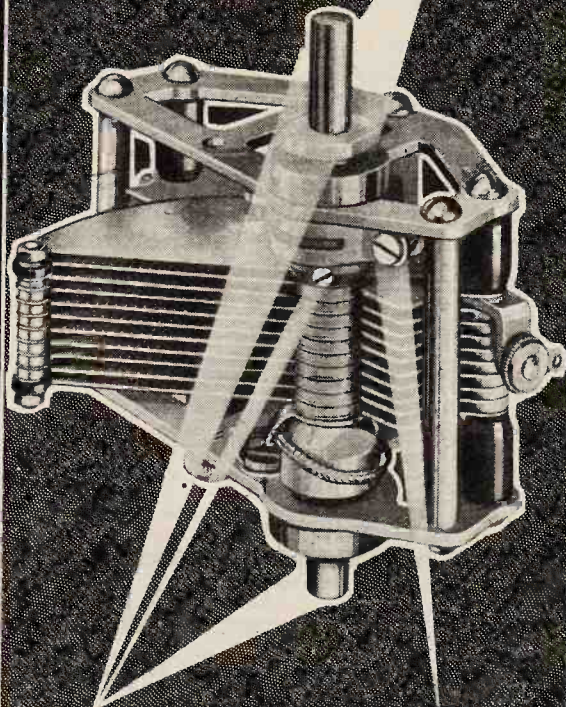

Steel Centre Spindle, adjustable for length and particularly useful for ganging and attaching to Thumb or Drum Control.

Showing the well-known J.B. adjustable tension to Centre Spindle.

Advertisement of Jackson Brothers, 72, St. Thomas' Street, London, S.E.1. Telephone: 110p 1837.



**STORE YOUR WIRELESS GOODS WHERE YOU CAN FIND THEM**

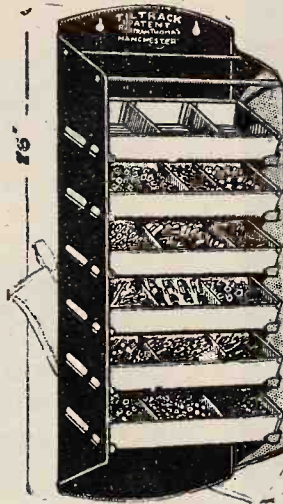

**"TILTRACK" (Junior)**

Price 30/- Post Free

Ideal for the Experimenter and the Household for storing Nuts, Bolts, Screws, Washers, Condensers and Small Components.



**"TILTRACK" (Senior)**  
 The ideal stores for the Retailer and Factory—

Goods found in minimum time with minimum trouble. Patent adjustable partitions to trays. Maximum illumination. No danger of Fire. Great Storage Capacity.

**THE "BENCHRACK."**  
 (Tiltrack Principle.)

Made to stand on the work bench; thus all small parts needed for the job in progress are immediately to hand. The trays are provided with patent hinging partitions, and the front face of each tray is rounded to facilitate quick removal of the goods in the tray. This rack is a tremendous time saver.

Price 30/- Carriage Extra

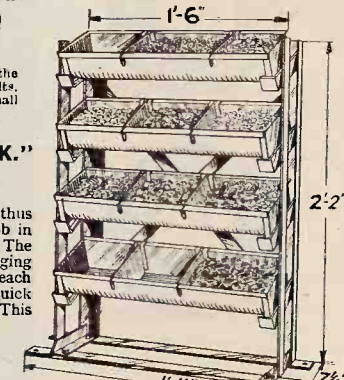

**"TILTACCESSORIES"**

ACCESSORIES to "TILT RACK" TRAYS, for "JUNIOR" and "SENIOR."

These are square boxes for fitting into the "Junior" and "Senior" Trays. Extremely useful for small details as screws, washers, etc. The illustrations below show the boxes as fitted to the "Senior" Trays.

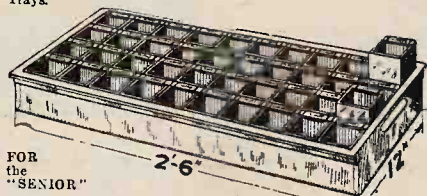
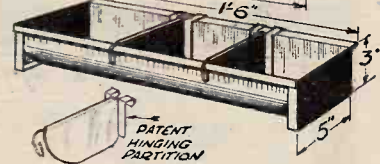

FOR the "SENIOR"



Particulars from Manufacturer & Patentee:— **Worsley Street, Hulme, MANCHESTER.**

London Office & Showroom:—28, Victoria Street, S.W.1.

Mention of "The Wireless World," when writing to advertisers, will ensure prompt attention.

# WISE WIRELESS USERS PREFER BATTERIES

## BECAUSE -



pure H.T. current comes only from a dry battery, for it contains steady, direct current and does not depend upon humming generators for its source of supply.

Batteries are handy, portable and safe, too; and cheaper in the long run—no expensive valves or windings to burn out.

Buy a battery and get the best in EVER READY, the battery that has stood the test for 25 years.

During Radio Week ensure perfect reception of the special programmes by fitting an EVER READY BATTERY to your set.

Use an EVER READY refill battery for your Electric Hand Lamp.

**The Popular Batteries for Portable Sets.**

PORTABLE 1.	
63 volts, 6 x 5 x 3".	8/6
PORTABLE 2.	
99 volts, 9 x 5 x 3".	13/6
PORTABLE 3.	
108 volts, 10 x 5 x 3".	15/-



# EVER READY

REGD TRADE MARK

## BRITAIN'S BEST BATTERIES

The  
**Wireless**  
AND  
RADIO REVIEW **World**  
**DIARY**  
for 1930

**Useful throughout  
the 12 months ahead**

"The Wireless World Diary" contains 80 pages of useful facts and figures for wireless users, together with ample space for memoranda and personal notes on radio matters.

**Get Your Copy!**

**PRINCIPAL CONTENTS :**

Summary of Regulations Relating to Amateur Transmitter and Receiving Licences. Conversion Tables, English measures to metric and *vice versa*. Decimal and metrical equivalents of fractions of an inch. Broadcasting Stations of Europe with their Call-Signs and Wavelengths. Principal Short-Wave Broadcasting and Commercial Stations of the World. Nationality Prefixes used by Amateurs. Morse Code. Symbols used in Wireless Diagrams. Typical Wireless Receiver and Eliminators :—Fourteen Different Circuits with Diagrams. Valve Data, giving the characteristic features of standard valves.

Published jointly by

"THE WIRELESS WORLD," LONDON, E.C.4,  
and CHARLES LETTS & CO.

**PRICES :**

Cloth Bound 1/- net. By post 1/1.  
In Leather Case, with pockets, pencil and season ticket window, 2/6 net. By post 2/7.

From all Booksellers and Stationers

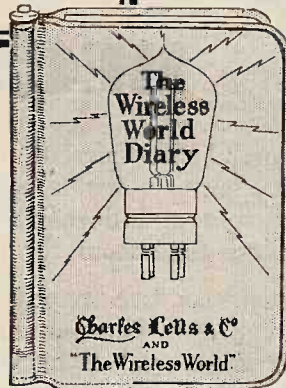

**PHOTOGRAMS OF THE YEAR**

THE ANNUAL REVIEW FOR 1930 OF THE WORLD'S PICTORIAL PHOTOGRAPHIC WORK

Edited by F. J. MORTIMER, F.R.P.S.

Editor of "The Amateur Photographer and Cinematographer."

This year's edition of "PHOTOGRAMS OF THE YEAR" is now on sale, and lovers of pictures made by the camera will give it a warm welcome.

"PHOTOGRAMS" contains reproductions of the most striking and representative pictures from the principal photographic exhibitions of the year, selected from the work of the leading pictorial photographers of the world.

A literary section provides reports of photographic progress at home and overseas, and a useful Directory of British Photographic Societies is included.

For keen photographers the annual volume of "PHOTOGRAMS" is an inspiration; for those to whom camera pictures appeal it is a book which gives lasting pleasure.

From all leading booksellers or direct from the Publishers:

ILIFFE & SONS LTD., Dorset House, Tudor Street, London, E.C.4.

**PRICES:**  
Paper Covers 5/-  
Cloth Boards 7/6  
Postage 6<sup>d</sup>. extra.

Mention of "The Wireless World," when writing to advertisers, will ensure prompt attention.

# £20 New Year's Gift Competition

Open to All  
 Readers of "The Wireless World"  
**HIDDEN ADVERTISEMENTS**

Below will be found six reproductions of fragments taken from the Advertisement pages of this issue of "The Wireless World." Each fragment is a clue. Can you from these clues identify the Advertisements? Eight prizes will be awarded to the first eight readers who send us correct solutions. No technical skill is required, merely observation. There are no restrictions or entry fees and the conditions are simple.

## First Prize

An order entitling the winner to purchase goods as advertised in this number of "The Wireless World" to the value of

**£7. 10s.**

for the first correct solution opened.

## Third Prize

An order entitling the winner to purchase goods to the value of

**£2. 10s.**

for the third correct solution opened.

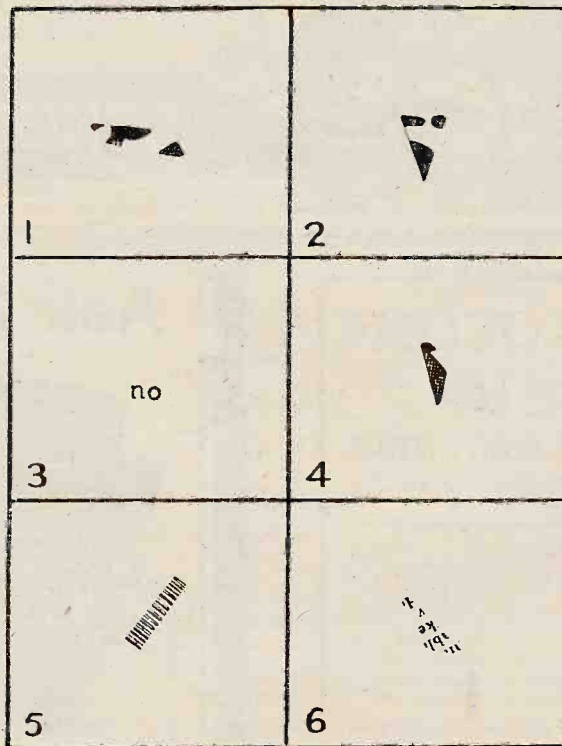

## Second Prize

An order entitling the winner to purchase goods to the value of

**£5**

for the second correct solution opened.

## 5 Consolation Prizes

of goods to the value of

**£1 each**

for the next five correct solutions opened.

### CONDITIONS

1. All solutions must be written on the special coupon appearing on an advertisement page in this issue and addressed to *The Wireless World*, Dorset House, Tudor Street, London, E.C.4, and marked "Hidden Advt." in bottom left corner.
2. Clues will not, of necessity, appear in the same way as in the advertisement page, but may be inverted or placed in some other position.
3. In order that town and country readers may compete on equal terms, solutions will not be dealt with until 10 a.m. on Monday, January 13th. All solutions received before that date will be retained until Monday morning. Competitors may submit

- any number of entries. Erasures or alterations on a coupon will disqualify the entry.
4. The first prize of £7. 10s. will be awarded for the first correct solution opened; the second prize of £5 for the next correct solution; the third prize of £2. 10s. for the third, and five consolation prizes of £1 each for the next five correct answers. In the event of no readers sending correct solutions the prizes will be awarded to the competitors whose solutions are most nearly correct.
5. The decision of the Advertisement Manager of *The Wireless World* is final, and no correspondence can be entered into. Competitors enter on this distinct understanding. No member of the staff of the paper is permitted to compete.



**-and no crackle**

Every sal-ammoniac battery begins to "crackle" far too soon. "Pertrix" simply cannot "crackle," for its electrolyte produces no corrosion. Nor can "Pertrix" lose power when not in use. These two points alone place "Pertrix" in a peerless position.

Use no battery but that with "pep."

**PERTRIX**  
SUPER LIFE  
H.T. BATTERIES

PERTRIX LIMITED, Britannia House,  
Shaftesbury Avenue, London, W.C.2.  
Factory: Britannia Works, Redditch, Worcs.

**LONGER LIFE!**

The **Wireless** COUPON  
and Radio Review **World** for

**"HIDDEN ADVT." COMPETITION**

The latest time for receiving this Coupon is 10 a.m.,  
Monday, January 13th, 1930.

Clue No.	Name of Advertiser.	Page
1		
2		
3		
4		
5		
6		

I enter the above solution subject to the published rules.

Name \_\_\_\_\_  
(Please write clearly)

Address \_\_\_\_\_

**Ask for**

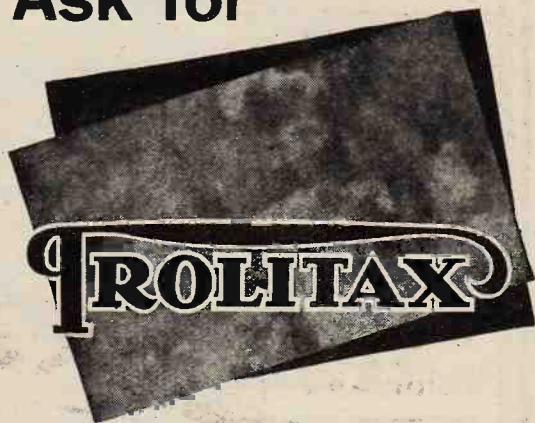

When constructing your new set, ask for a Trolitax panel. Your dealer can supply Trolitax cut to the size you require in whatever finish you choose. Its insulating properties are excellent and it is easily workable and reliable under *all* conditions. You cannot do better than a Trolitax panel. Ask to see the range of finishes.

**F. A. HUGHES & CO., LIMITED**

204-6, Great Portland Street, London, W.1

Phone: Museum 8630 (4 lines).

Distributors for Northern England, Scotland and North Wales:  
H. C. Rawson (Sheffield and London), Ltd., 100, London Road,  
Sheffield. Phone: Sheffield 26006. 22, St. Mary's Parsonage,  
Manchester. Phone: Manchester City 3329.

Mention of "The Wireless World," when writing to advertisers, will ensure prompt attention.

**NATIONAL  
RADIO  
WEEK**

JANUARY 12th to 18th,  
1930.

*We regret that  
some of our  
customers wer  
disappointed over  
delivery at Xmas.  
With the New Year  
we are extending  
our factory to meet  
the demand.*

**Get the Experts to  
Advise You:—  
The R.G.D. Radiogramophone**



For the highest possible quality and tone for both radio and record, with ample volume, incorporating the latest developments in moving coil speaker; operates entirely from electric mains, A.C. any voltage, or D.C. 200 volts or over.

Mahogany  
**£80**

**A Pick-Up  
of  
Distinction.**



The R.G.D. Magnetic Pick-up is designed after years of experiments, and we believe it to be as perfect as possible. No record wear, perfect tracking, a scientific instrument, specially developed for moving coil speaker reproduction. Price **£3** in bronze, **£3-3-0** in oxidised silver.

*Place your order now to ensure delivery and we shall be pleased to supply literature on application.*

**The Radiogramophone Development Co.,  
St. Peter's Place, Broad Street, Birmingham.**

**STANDARDS**



**The  
IMPERIAL PINT  
and T.C.C.**

**T**HE Imperial Pint is the Standard pint—the pattern for all pints. Many pint pots are etched with the Imperial Pint mark—such a pot, filled, contains true measure. There is also a standard among condensers—and that is T.C.C. Every condenser marked "T.C.C." is an assurance that it is up to standard. T.C.C. Condensers, because of their accuracy, dependability and good service are to-day the recognised standard of all condensers—that's the opinion of experimenter, scientist and amateur alike. Remember this when next you want a condenser.

The illustration above is of the 2 mfd. Paper Condenser (Licensed under Design Reg. No. 723,271) Price 3s. 10d.—Other capacities from .005 to 10 mfd. Prices 1s. 8d. to 18s. 6d.



*Adv. Telegraph Condenser Co., Ltd., Wales Farm Rd., N. Acton, London, W.3* 

B9 Advertisements for "The Wireless World" are only accepted from firms we believe to be thoroughly reliable.

# Centralab

Control is everything



Your radio or electrical gramophone must carry on every time you snap on the switch. Your volume control must function smoothly, easily—consistently if you wish to be rewarded with perfect reproduction. No radio is perfect unless it is Centralab equipped. Centralab Modulators and Potentiometers are used as standard by all the leading manufacturers—this is an insurance of supreme quality.

Our 1930 4th Edition of the "Great Voice" booklet tells you all about Centralab Volume Controls and their uses. This 68-page booklet contains numerous diagrams and information of paramount importance to all constructors of radio sets, gramophones, etc. Send 6d. in stamps for postage.

POTENTIOMETERS.

Type P.	109	0-200	ohms.
"	P. 110	0-400	"
"	P. 111	0-2,000	"
"	P. 112	0-10,000	"
"	P. 050	0-50,000	"
"	P. 100	0-100,000	"

MODULATORS.

"	M. 250	0-250,000	"
"	M. 500	0-500,000	"

All 10/6 each.

THE ROTHERMEL CORPORATION LTD.,  
24, Maddox Street, London, W.1.

Phone: MAYFAIR 0578/9.

## FORMO

"1930" LOG (mid line)  
CONDENSER

"Have always held a leading position . . . production of thoroughly sound variable condensers . . ."—*Vide Press.*

"MIDGET" Reaction  
CONDENSER

Capacity: .0002 mfd.

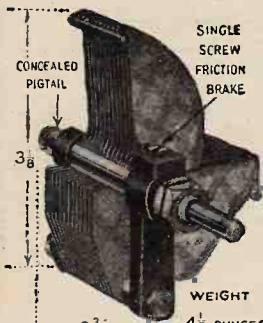

WEIGHT 4 1/2 OUNCES

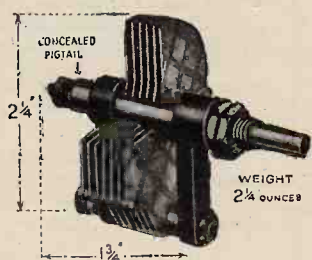

WEIGHT 2 1/4 OUNCES

The FORMO "MIDGET" Reaction Condenser, like all other Formo Condensers, has incorporated the patented Formo internal "PIGTAIL," undoubtedly the finest collector or "Pigtail," yet devised, and thereby is absolutely noiseless in operation.

In four Capacities. **4/6** each.

- \*0005
- \*00035
- \*00025
- \*00015

\*Double spacing of vanes for Ultra Short wave work.

If unable to obtain from dealer please communicate with us. Full Catalogue sent post free on receipt of post card.

THE FORMO CO., CROWN WORKS,  
CRICKLEWOOD LANE, LONDON, N.W.2

Use

the



## "MAJOR" Cabinet



Complete with 16 1/2" baseboard and removable baffle board.

FOR YOUR

**RADIO-GRAM**

Especially suitable for  
**MULLARD ORGOLA,  
OSRAM MUSIC  
MAGNET,**

and for panels up to 18" x 8".  
Loud Speaker compartment is  
18" x 18" x 16 1/2"

**OAK - - £7: 10: 0**  
**MAHOGANY £7: 15: 0**

Call and see full range of "Camco" cabinets at new London showrooms.

CARRINGTON MANUFACTURING CO., Ltd.

New Showrooms, 24, Hatton Garden, London, E.C.1.

Telephone: Holborn 8202.



Get improved reception with this long-life BATTERY

66 Volts  
**7'9**

SUPERIOR (Single Capacity)

9 volts	1/6	99 volts	11/9
63 "	7/6	108 "	12/9
66 "	(with C.B. Tappings)		7/11

SUPREME (Treble Capacity)

60 volts	13/6
63 "	14/3
100 "	22/-

Get Dubilier's Booklet—"A Bit about a Battery"—from your Radio dealer



BRITISH MADE

# DUBILIER

H.T. BATTERIES

DUBILIER CONDENSER CO. (1925) LTD., Ducon Works, Victoria Rd., North Acton, London, W.3.



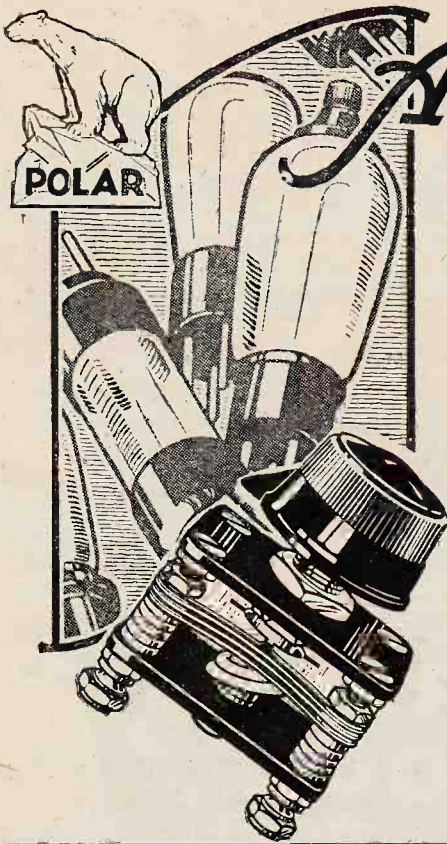

# An aid to accurate tuning . . . . .

The use of the Polar Differential Condenser in your reaction circuit eliminates the necessity for retuning when reaction is adjusted; it also gives much greater control over oscillation. By aiding the accuracy of your tuning it gives you stronger and clearer reception, especially on distant transmissions. Excellent in all circuits, but particularly suitable for screened-grid valve circuits.

## POLAR DIFFERENTIAL CONDENSER

For Reaction or Volume Control

Strongly built of brass on a moulded frame and fitted with bakelite di-electric to prevent risk of shorting.

.0001 each side **6/6**  
.00015 each side **7/-**

.00025 each side **7/6**  
.0003 each side **8/6**

Send for the Polar Catalogue (W).

WINGROVE & ROGERS LTD.  
188-189 STRAND, LONDON, W.C.2

*Polar Works: Mill Lane, Old Swan, Liverpool.*

## SMALL COMPONENTS OF BIG IMPORTANCE



### IGRANIC-PACENT JACK

Of German silver, with silver contacts and nickel-plated non-magnetic brass frames. Insulated and adjustable fixing bush with lugs tinned and fan-tailed to facilitate soldering. From **2/-**



### IGRANIC-PACENT UNIVERSAL PLUG

Nickel-plated with black or mahogany-finished shell. Merely insert phone tags in connector springs, clamp shells together and obtain a biting grip with thorough electrical contact. **1/6**



### IGRANIC FIXED CONDENSER

Moisture proof. Highest performance under all conditions. Constant capacity, and di-electric losses practically non-existent. The plates are of highest quality brass, and only the finest selected Ruby Mica is used. .001 mfd. to .01 mfd. **1/3**



### IGRANIC INDIGRAPH INSULATED TERMINAL

Made of best quality bakelite with non-rotating engraved title base and socket for extra connections by means of a wander plug. Twenty-nine titles and in plain red, green and black. **6d.**



If your Dealer cannot supply you, please write direct to Dept. U.304.

### IGRANIC SPRINGMORE PLUG

Self-adjustable, therefore indispensable for varying diameter of H.T. and grid bias battery sockets. Combines function of socket so that one plug may be fitted on top of another. Ensures positive electrical connection and cleans socket into which it is plugged. **3d.**





**B**ECAUSE of its Interlocked Construction the *NEW* Cossor Screened Grid has a degree of strength never before attained in any valve. Unit by unit its elements are assembled — each joint electrically welded — each unit reinforcing and locking the previous one until the whole structure assumes a girder-like rigidity. Even the hardest blow cannot disturb its perfect alignment. For strength, for power and for long life use the *NEW* Cossor Screened Valve in your Receiver, no other make has Interlocked Construction.

**2-volt type  
now available.**

Cossor 220 S.C. (2 volts, .2  
amp.) Anode volts 120-150,  
Impedance 200,000  
Amplification Factor **22/6**  
200. Price . . . . .

Cossor 4 and 6 volt Screened  
Grid Valves are also available  
with similar characteristics at  
the same price.

# The NEW COSSOR Screened Grid Valve

A. C. Cossor, Ltd., Highbury Grove, London, N.5.

3099



# The Wireless World

AND  
RADIO REVIEW  
(17<sup>th</sup> Year of Publication)

No. 541.

WEDNESDAY, JANUARY 8TH, 1930.

VOL. XXVI. No. 2.

Editor: HUGH S. POCOCK.  
Assistant Editor: F. H. HAYNES.  
Editorial Offices: 116-117, FLEET STREET, LONDON, E.C.4  
Editorial Telephone: City 9472 (5 lines).  
Advertising and Publishing Offices:  
DORSET HOUSE, TUDOR STREET, LONDON, E.C.4.  
Telephone: City 2847 (13 lines). Telegrams: "Ethaworld, Fleet, London."  
COVENTRY: Hertford Street.  
Telegrams: "Cyclist, Coventry." Telephone: 5210 Coventry.  
BIRMINGHAM: Guildhall Buildings, Navigation Street.  
Telegrams: "Autopress, Birmingham." Telephone: 2970 and 2971 Midland.  
MANCHESTER: 260, Deansgate.  
Telegrams: "Hiffe, Manchester." Telephone: 8970 City (4 lines).  
GLASGOW: 101, St. Vincent Street, C2.  
Telegrams: "Hiffe, Glasgow." Telephone: Central 4867.  
PUBLISHED WEEKLY.  
Subscription Rates: Home, £1 1s. 8d.; Canada, £1 1s. 8d.;  
other countries abroad, £1 3s. 10d. per annum.  
Entered as Second Class Matter at New York, N.Y.  
*As many of the circuits and apparatus described in these pages are covered by patents, readers are advised, before making use of them, to satisfy themselves that they would not be infringing patents.*

---

CONTENTS OF THIS ISSUE.

	PAGE
EDITORIAL VIEWS	31
HIGH SELECTIVITY. BY W. T. COCKING	32
CURRENT TOPICS	36
GRAMOPHONE SPEED TESTER. BY H. LLOYD	37
IN SEARCH OF QUALITY. BY BERTRAM MUNN	39
NEW APPARATUS REVIEWED	41
WIRELESS THEORY SIMPLIFIED. PART XVII. BY S. O. PEARSON	42
NEW METHOD OF DETECTION USING A.C. VALVES	45
BROADCAST RECEIVERS: IGRANIC NEUTROSONIC SHORT-WAVE SET	47
PICTURE RECEPTION IN THE AIR	49
BROADCAST BREVITIES	51
A NEW RECTIFYING VALVE. BY E. R. DIETZE	52
LETTERS TO THE EDITOR	54
READERS' PROBLEMS	57

we sincerely hope that it will never be proceeded with. Before the Broadcasting Corporation was formed broadcasting in this country, it may be remembered, was conducted by a company composed, or rather guaranteed, by the principal radio set manufacturers who also largely controlled the policy of the company. In those days a substantial contribution was made by manufacturers towards the cost of programmes, the contribution taking the form of a charge on sets sold, but fortunately this arrangement came to an end, and the revenue for programmes has since been derived from a proportion of the licence fees paid by the public through the Post Office. To reinstate the old arrangement would, in the first place, mean an increase in the cost of receivers to the public and would be equivalent to charging a higher rate for the annual licence. No scheme whereby the public is called upon to contribute a larger sum towards broadcasting is to be recommended so long as it is possible to avoid it. Further, it does not seem to be desirable that the responsibility for the programme matter and general policy of the B.B.C. should be divided, and we certainly do not think that the manufacturers themselves would desire to accept part responsibility, although we believe that they would welcome a rather closer co-operation than has existed in the past. This position is, however, improving and the B.B.C. is no longer inclined to make rash decisions with regard to rearrangement of stations, or changes in wavelength, without first discussing the position with the manufacturers in order to ascertain how far the public as users of receivers will be affected by the change.

## SHOULD MANUFACTURERS CONTRIBUTE TOWARDS PROGRAMMES?

THE suggestion has recently been made that the B.B.C. does not keep closely in touch with the manufacturers of receiving sets who, since they are catering for the requirements of the public, really represent the listening public as far as the practical side of reception is concerned. It has been proposed that in order to remedy this state of affairs the manufacturer should contribute a royalty on the receiving sets which he sells, to go towards the cost of the programmes, in order that there shall be some link between the revenue of the B.B.C. available for broadcasting and the sale of receivers, and also to give the manufacturer a claim to a more positive influence on the programme policy than he has at present.

There are, of course, arguments which can be brought forward to support such a proposal but, on the other hand, there are so many objections to the scheme that

## RADIO WEEK, JANUARY 12th—18th.

"GO Home and Listen" is the slogan for Radio Week 1930, which is arranged for the week beginning January 12th.

During Radio Week, as in previous years, the B.B.C. will put out programmes of special attraction, and the object of Radio Week is to widen the circle of listeners so as to bring us nearer to the position when every home will be linked together through the medium of the broadcasting service.

We hope that our readers will co-operate during Radio Week in recruiting new listeners from amongst their friends who have up to the present failed to interest themselves in broadcasting. The fact that special programmes have been planned will help to emphasise the advantages which are to be found in the ownership of a broadcast receiver.

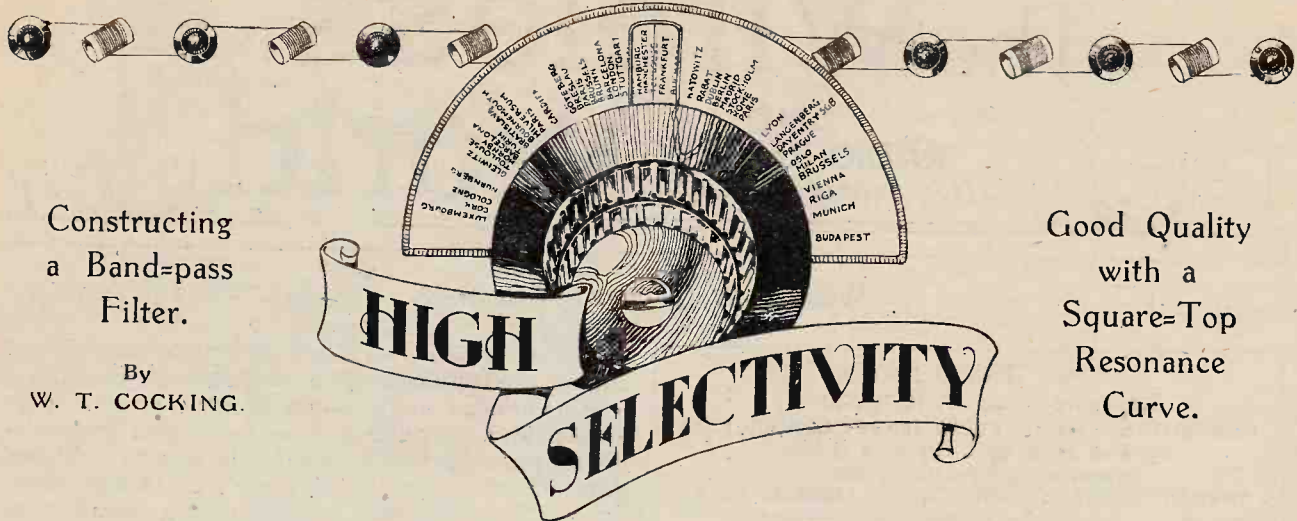

## Constructing a Band-pass Filter.

By  
W. T. COCKING.

Good Quality  
with a  
Square-Top  
Resonance  
Curve.

*At the present time with the regional scheme in force there is an ever-growing quest for high selectivity without distortion. There is a fund of information in the accompanying article on the design of filters which are a good compromise between selectivity, quality and magnification. It is shown that several stages can be ganged, thus considerably facilitating the control of a receiver.*

THERE is little doubt that the band-pass filter offers the best solution to the problem of obtaining adequate selectivity and high quality at short distances from the Brookmans Park transmitter. While the circuit is simple to set up and operate, the results with it are principally dependent upon the degree of coupling between the primary and secondary circuits; for, if this is incorrect, poor signal strength and bad quality may be obtained.

In Fig. 1 is given the circuit diagram of a filter, coupled by mutual inductance between the coils, which is used as the sole means of tuning before a grid rectifier. Fig. 2 shows the effect on magnification (curve A), on the side-band variation (curve B), and on the selectivity (curve C) of varying the value of the mutual inductance. These curves are for a wavelength of 500 metres and for coils having an inductance of 240 microhenries and an H.F. resistance of 5 ohms. This last condition will not be true when a filter is used before a grid detector, owing to the heavy damping imposed by this method of rectification; but when reaction is used there will be a certain setting of the reaction condenser at which the curves are exactly true.

It will be seen that there is an optimum value of coupling for both magnification and side-band variation, and that the optimum is not the same for both. The selectivity, on the other hand, always increases with a decrease in the coupling. The greatest efficiency is

obtained when the mutual inductance is 1.5 microhenries, for then the magnification is 90, a figure which is exactly half that for one identical tuning coil used in the orthodox manner. The selectivity with this degree of coupling is quite high, being 240 at 40 kc. from resonance; the unfortunate part, however, is that the side-band variation is 75 per cent., which is altogether excessive. With a mutual inductance of 3 microhenries, the best value for quality, the side-band variation is only 5 per cent., but the selectivity has fallen to 85, and the magnification to 66. In practice, therefore, it is usually necessary to make a compromise between

the three conflicting requirements, selectivity, quality, and magnification.

Opinions differ as to which is the best compromise, but it is suggested that a maximum high note loss of 40 per cent. at a frequency of 5 kc. either side of the resonance frequency will usually meet the case. It is probable that a side-band variation of this order would be quite undetectable by the average person, as the ear is very insensitive to changes in strength; particularly is this so when the changes occur at different frequencies. Taking this figure, then, as the maximum allowable, the best value for the mutual inductance is 2.5 microhenries, with which the magnification is 75 and the selectivity is 120.

Fig. 3 gives the results with the same filter at a wavelength of 250 metres, at which the coil resistance is 10 ohms. It is interesting to note that, for mag-

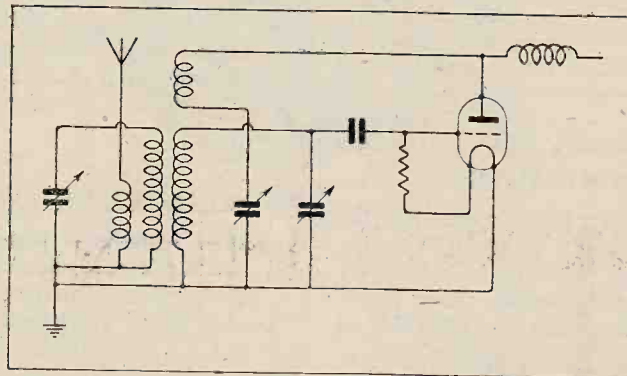

Fig. 1.—A filter circuit preceding a leaky-grid detector.

**High Selectivity.**—

nification, the best value for the mutual inductance is unchanged at this lower wavelength, but that the best value for quality is now 2 microhenries instead of 3 microhenries. Incidentally, the best value of mutual inductance for magnification can be found very easily for the case when each coil has the same H.F. resistance; it is only necessary to choose a value of mutual inductance such that its reactance is equal to the H.F. resistance of one coil at

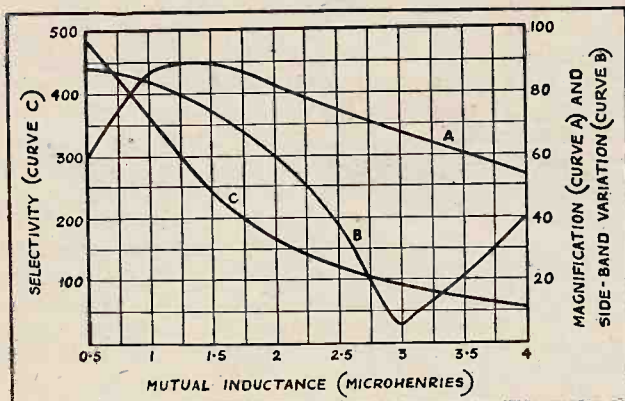

Fig. 2.—Curves for a mutual-inductance coupled filter in aerial circuit at 500 metres. A shows the effect on magnification, B the effect on side-band variation, and C the change in selectivity.

the same frequency. This may be expressed in the following simple manner:—

$$M = R/\omega \text{ where } M = \text{mutual inductance in henries.}$$

$$R = \text{H.F. resistance of one coil in ohms.}$$

The greatest difference between the curves for 250 metres and those for 500 metres is in the selectivity, which is much less at the lower wavelength. A value of mutual inductance (2.5 microhenries) which gives a 40 per cent. high note loss at 500 metres and a selectivity of 120 will give at 250 metres a side-band variation of 18 per cent. and a selectivity of 27; not only this, the side-band variation is no longer in the form of a high-note loss, but is what is perhaps best called a high-note accentuation. A selectivity of 27 at 250 metres, however, is still high in comparison with that of a single-tuned circuit at this wavelength. The falling-off in selectivity is normal and unavoidable with the usual method of tuning by variable condensers. It is due partly to the higher ratio of inductance to capacity, but principally to the increased coil resistance at the lower wavelengths.

**Selectivity Under New Exacting Conditions.**

For a receiver of the type of Fig. 1 these figures for selectivity are unusually high, and also the high-note loss is less than with a single-tuned circuit. In practice, the signal strength is less than that with normal tuning arrangements, the aerial winding in each case being chosen for maximum strength. When, however, the turns on the aerial winding are reduced for selectivity, as is commonly done, the filter with a full aerial winding is far superior as regards strength, quality, and selectivity. Brookmans Park, at a distance of nine miles, causes far less jamming with an

o-v-2 filter-tuned set than did the old 2LO on the same set and at the same distance, but with an ordinary single coil. Thus not only the Daventry Experimental station but Continental stations intermediate in wavelength can be received without a trace of Brookmans Park. It should be noted that the operation is not complicated, for the two tuning condensers are ganged.

Curves A and B of Fig. 4 and curve A of Fig. 5 show the selectivity, amplification, and side-band variation respectively with an H.F. amplifier consisting of a filter-tuned aerial circuit and a Mazda AC/SG valve coupled to the detector by another identical filter circuit—four tuned circuits in all. These curves show that for high quality the mutual inductance must be a little greater than when one filter only is used. This results in a somewhat higher loss of both amplification and selectivity. With a mutual inductance of 2.75 microhenries for each filter the side-band variation is 40 per cent., the amplification 6,400, and the selectivity 10,000! Lest it should be thought that selectivity of this order is unnecessary, it may be as well to quote figures for an amplifier satisfactory under the old broadcasting conditions and to show the increase in selectivity now essential if the apparent selectivity of the set is to remain the same.

**Relative Signal Strengths of Old and New 2LO.**

A set consisting of a tuned grid circuit with a tuned anode and a P.M.12 valve with a 5-ohm coil for the grid circuit and a 10-ohm coil for the anode has, at 500 metres, an amplification of 8,750, a selectivity of 213, and a side-band variation of 79 per cent. These figures are typical of well-designed H.F. stages of receivers of a year or so ago. Generally speaking, the amplification is quite sufficient for first-class reception of foreign stations on a good aerial. At distances of ten miles or more from the old London station the selectivity was great enough to allow the reception of stations working with about a 60 kc. separation from 2LO, but

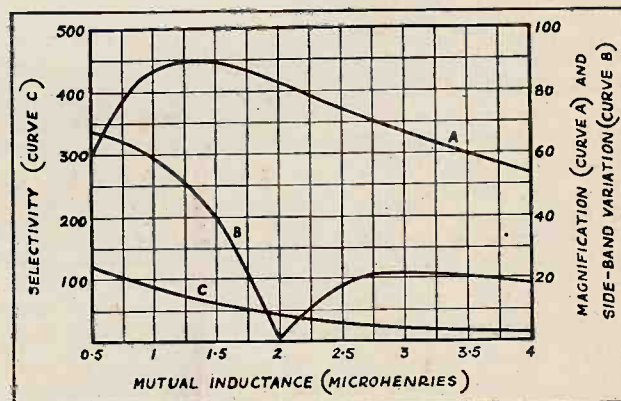

Fig. 3.—The same filter as in Fig. 2 but the curves are taken at 250 metres at which the coil resistance is 10 ohms.

the quality was usually poor due to side-band cutting. Now the power of the new station is about fifteen times that of the old, so that if the receiver is used at the same distance from it the selectivity must be increased fifteen times; that is, it must now be 3,195. If, in addi-

**High Selectivity.—**

tion, the new station is not so far away, a still further increase will be necessary. In the case when it is only one-third as far away, a further increase of three times is needed; that is, the total selectivity needed to get the same apparent selectivity as before is 9,585. It will be seen that a selectivity of 10,000 is not excessive for those living close to Brookmans Park.

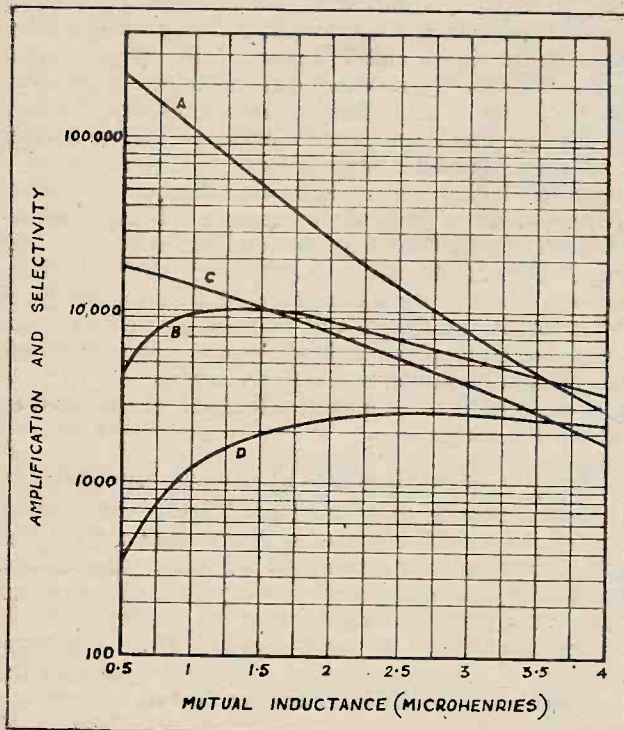

Fig. 4.—Showing the effect of mutual inductance on amplification and selectivity. Curves A and B show selectivity and amplification respectively for two filters with 5-ohm coils and an AC/SG valve at 500 metres. Curves C and D are for similar conditions but with 10-ohm coils.

If, therefore, an old set is rebuilt to include two band-pass filters the apparent selectivity on the new station will be about the same when it is one-third the distance away; the quality will be much better, but the amplification will suffer a slight decrease, for it will be about 25 per cent. less. This is, of course, provided that in both cases the optimum number of turns for the aerial winding is used.

When one comes to consider practical details, however, one finds that it is almost impossible to use coils having an H.F. resistance as low as 5 ohms when connected in circuit. The standard *Wireless World* type of Litz wound coil has this value of resistance when in circuit. But since the dimensions of this coil are about 3in. x 3½in., under ordinary circumstances it is obviously impossible to use four coils of this size. Not only is it difficult to find sufficient space for large coils, but it is not easy to obtain sufficiently loose coupling between the primary and secondary coils of the filter. It can be shown that the lower the coil resistance the looser is the coupling required, and this accentuates the difficulty. In addition, the use of large coils greatly in-

creases the risk of instability owing to their large external field. In practice, the only satisfactory way of using this type of coil in a filter circuit is to use either inductance or capacity coupling and to screen each coil completely.

While considering large coils, which have a low H.F. resistance and therefore give greater amplification, it is as well to point out that the amount of amplification affecting stability is greater than the stage amplification. The stage amplification is the overall amplification from the grid of the H.F. valve to the grid of the detector. The actual amplification affecting stability is the ratio of the voltage developed across the *primary* coil of the anode filter to the voltage on the grid of the H.F. valve. This may be nearly double the stage amplification, and with low resistance coils may cause trouble due to feedback through the grid-anode capacity. The coils to be described later in this article can be relied upon to give no trouble in this respect; they have a calculated H.F. resistance at 500 metres of 5 ohms, but when connected in circuit the figure will be higher. The exact figure is rather uncertain, but it is probably in the neighbourhood of 7 or 8 ohms; in any case, it is not greater than 10 ohms. The actual results with these coils, therefore, will be between those with 5-ohm coils and those with 10-ohm coils.

**Using Four Tuned Circuits.**

Curves C and D of Fig. 4 and curve B of Fig. 5 give the selectivity, amplification, and side-band variation respectively for a one H.F. set using two filter circuits with coils having an H.F. resistance of 10 ohms at 500 metres. An inspection of these curves reveals an interesting point; for a high-note loss of 40 per cent, a mutual inductance of 3 microhenries is required, and

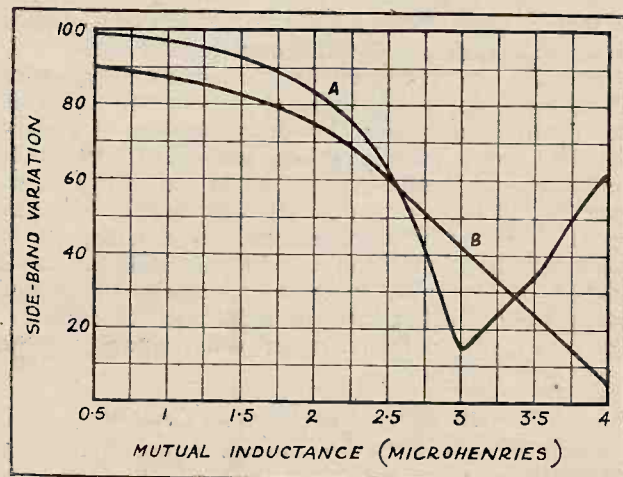

Fig. 5.—Side-band variation with change in mutual inductance. Curve A shows side-band variation with two filters, 5-ohm coils and an AC/SG valve at 500 metres. Curve B conditions are the same as those in curve A, but the coils are of 10 ohms resistance.

this is also the optimum value for amplification. With coils of 10 ohms resistance, therefore, the operation of adjusting the coupling is simple as it is only necessary to adjust for maximum strength. On the other hand, the best value of mutual inductance for quality is 4 microhenries, with which value the side-band variation

**High Selectivity.—**

is only 5 per cent., a truly remarkable figure for a set having four tuned circuits! Furthermore, the loss in amplification with this increase in coupling is only 14 per cent., an amount which is only just detectable by ear. The loss in selectivity with this tighter coupling, however, is rather more; it falls from 3,800 to 1,720, that is, a loss of 55 per cent. In some cases it may be a worth while loss, for the selectivity is still high in comparison with that of an ordinary set. It is not high enough, however, to give the best results near a high-power transmitter.

Earlier in this article it was said that a selectivity of

3,195 was necessary for good results at ten miles or more from Brookmans Park; if a 40 per cent. high-note loss is considered allowable, this degree of selectivity can easily be obtained by using two filter circuits with 10-ohm coils, each filter being coupled by a mutual inductance of 3 microhenries. The selectivity with this arrangement is slightly greater than is essential; and this is borne out in practice, for two filter circuits with the recommended coils give distinctly greater apparent selectivity with the new station than did two tuned circuits when the old 2LO was working.

(To be concluded.)

**LOUD SPEAKER DEVELOPMENTS.**

According to patent No. 312,756, a more even distribution of the energy applied to the diaphragm is ensured by using four moving coils instead of one. The coils  $A_1, A_2, A_3, A_4$  are wound on cardboard rings spaced equally apart on the diaphragm D, as shown in Fig. 1. They co-operate with gaps formed in the pole-pieces of the four-pole magnet

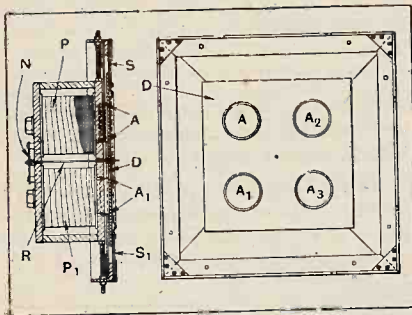

Fig. 1.—A speaker with four speech coils to ensure a more even distribution of energy. (No. 312,756.)

$P, P_1$ , etc. The windings may be connected in series or in parallel. The diaphragm D is supported around the edges by thin leather strips  $S, S_1$ , and is centred by a rod R.

In the arrangement shown in Fig. 2

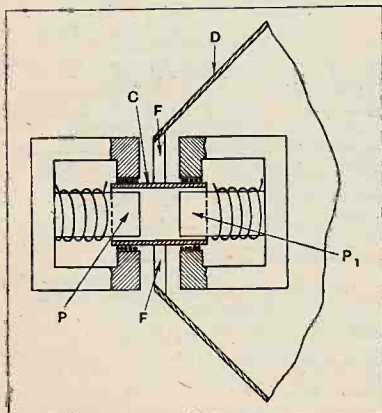

Fig. 2.—A moving coil with two pot magnets so arranged that the electrodynamic effects are additive. (No. 312,950.)

B 17

**RECENT INVENTIONS OF WIRELESS INTEREST.**

(patent No. 312,950) the moving coil C is mounted to co-operate with two adjacent pot-magnets  $P, P_1$ , the windings of the coil being divided into two sections so that the electrodynamic effect is additive. The diaphragm D is connected to the moving coil by arms F extending radially outwards through the space between the adjacent magnets.

o o o o

**L.F. TRANSFORMERS.**

In the ordinary way the primary windings of the output transformer of a valve amplifier carries a direct-current component, as well as a fluctuating low-frequency current. The presence of the former may give rise to various undesir-

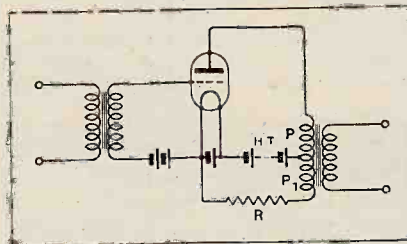

Output transformer with primary having two oppositely wound sections. (No. 313,229.)

able effects. For instance, if there is any residual "ripple" in the H.T. supply from an eliminator unit, the ripple will be transferred to the secondary winding and so pass on to the loud speaker. Again, the steady-current component may cause the transformer to operate on an unfavourable point of its magnetisation curve.

The arrangement shown in the figure (patent 313,229) is designed to prevent these drawbacks. The output primary consists of two oppositely wound halves  $P, P_1$ . The portion  $P_1$  is connected in series with a high resistance R across

the terminals of the H.T. supply, R being of such a value that the current flowing through the lower half of the windings exactly neutralises the effect of that flowing in the upper half. If any "ripple" is present in the H.T. source, this will also be balanced out so far as its effect on the secondary is concerned.

o o o o

**SUSPENSION SYSTEM FOR LOUD SPEAKER DIAPHRAGMS.**

An interesting method of suspending a loud speaker diaphragm is described in patent No. 313,646. The suspension is designed to allow the diaphragm to move freely to and fro in the direction of the applied forces, i.e., in the so-called plunger fashion, whilst at the same time the diaphragm can "flex" or vibrate internally under the action of the stresses and strains set up in the material of which it is composed. The diaphragm is prevented, however, from moving as a whole in a plane at right-angles to the direction of the applied driving-forces.

In one arrangement, Fig (a), tangential cords C are attached to the outer end of the cone, and form a square suspension, the corners of which are secured to a fixed support by auxiliary strings  $C_1$ . A second similar string support K may be provided near the narrow end of the cone. In another arrangement, Fig.

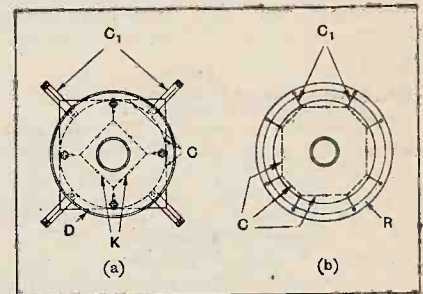

Two methods of suspending a loud speaker diaphragm to give "plunger" action. (No. 313,646.)

(b), the string suspension C is in the form of an octagon, each corner of which is connected by other strings  $C_1$  to a supporting ring R.

# CURRENT TOPICS

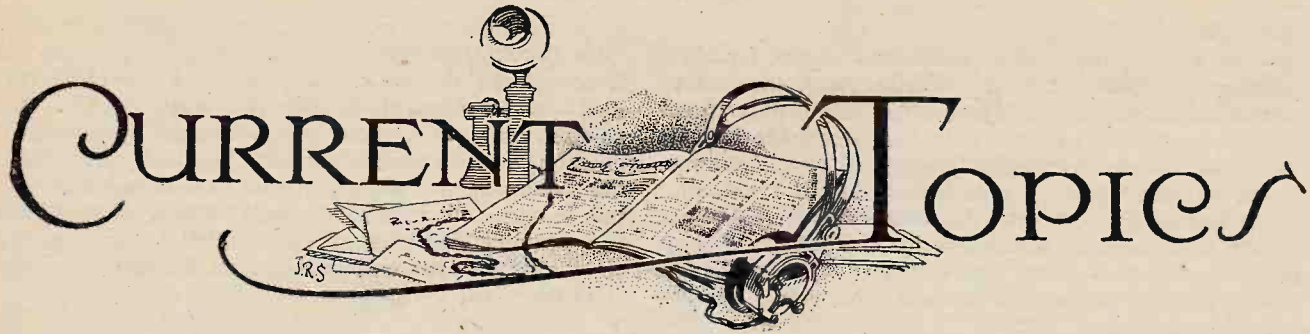

## Events of the Week in Brief Review.

### SETS ON APPROVAL: NO LICENCE.

To encourage listening in Germany the Post Office is collaborating with the wireless trade in the introduction of a "sets on trial" system. Under this scheme, prospective purchasers are allowed a set on approval for eight days without taking out a licence.

### IS RADIO-PARIS TOO ENGLISH?

The amount of British commercial publicity broadcast from Radio-Paris has led to a strong protest by the Paris evening paper, *L'Intransigeant*, which declares that listeners are praying for a new Joan of Arc to deliver the station while there is still time.

### MEASURING SET PERFORMANCE.

"A Method of Measuring the Overall Performance of Radio Receivers" is the title of a lecture to be delivered by Mr. H. A. Thomas at a meeting of the Wireless Section of the Institution of Electrical Engineers on Wednesday next, January 15th. The meeting will be at 6 p.m. at the Institution, Savoy Place, W.C.2.

### THE CENTRE OF GRAVITY.

The following extract from a school-boy's Christmas examination paper is forwarded to us by a well-known contributor:—

*Question.*—"What do you understand by the centre of gravity?"

*Answer.*—"The centre of gravity of the British Isles lies somewhere near Daventry, where the great wireless station is situated."

### WIRELESS AT SCHOOLBOYS' EXHIBITION.

To-day is the closing date of the Schoolboys' Exhibition at the Horticultural Hall, Westminster. Several interesting wireless features are displayed, including a typical ship set, exhibited by the Shipping Federation, and an emergency wireless telephone transmitter for use in districts where land lines are impracticable. The latter is shown by the Telephone Development Association. Several well-known radio firms are represented.

### WIRELESS SHOW IN HAVRE.

Havre is the first town to support the earlier exhibition movement. A radio and gramophone show will be held from January 31st to February 6th.

### THE JOYS OF OLD AGE.

Exemption from payment of licence fees is now granted to German listeners who are too old to visit a theatre.

### 24-HOUR SHORT-WAVE SERVICE.

Kenya Colony, which has already won laurels with its broadcasting station at Nairobi, has now started a 24-hour con-

### "GO HOME AND LISTEN."

*A bigger listening public means a better broadcasting service. This is the animating principle of National Wireless Week, which opens on Sunday next, January 12th. The B.B.C. is doing its share in recruiting new listeners by providing special programmes. Much more can be done by listeners themselves, who will benefit their own interests by widening the circle of radio enthusiasts.*

tinuous service from Mombasa. The Mombasa station works on 36.74 and 21.59 metres (C.W.) as well as on higher wavelengths for ordinary ship traffic.

### FREE DINNERS FOR LISTENERS.

A new inducement to listening in Denmark is afforded by a guessing com-

petition instituted by several broadcasting stations which transmit restaurant music. Listeners who can guess the titles of a given number of orchestral selections win a free dinner ticket.

### KIT SET FOR BROADCAST RELAY.

Press cuttings from South Australia have just revealed to Messrs. A. C. Cossor, Ltd., the British valve manufacturers, that one of their Melody Maker kit sets (last year's model) was recently used by station 5CL, Adelaide, in a broadcast relay of a transmission from station KGO, San Francisco. The Cossor set picked up San Francisco on 23 metres, and, according to listeners' reports, the results were excellent.

### THE RADIO "DIVINING ROD."

Oil prospecting by wireless and acoustic devices has engaged the attention of seven petroleum companies in the United States. The Federal Radio Commission has just allocated five frequencies for "geophysical exploration," these being 1,600, 1,652, 1,664, 1,680, and 1,704 kilocycles.

In the combined radio and acoustic devices calculations are based on the time lag between radio and sound waves transmitted simultaneously from a given spot. Geological and other considerations affect the speed of the sound waves, which often reveal the presence of oil.

### HIDDEN ADVERTISEMENTS COMPETITION.

Since we announced the results of the recent Hidden Advertisements Competition, a number of readers have enquired as to the correct solution of the mystery. The clues were taken from the following advertisements:—(1) Ferranti, Ltd.; (2) Westinghouse Brake Co.; (3) Formo Co.; (4) C. A. Vandervell and Co.; (5) C. F. and H. Burton, Ltd.; (6) Wm. Bayliss, Ltd.

### NATIONAL WIRELESS WEEK PROGRAMMES.

At the moment of going to press we learn of a change in the B.B.C. programme for Monday, January 13th. In place of the announced recital by Madam Suggia, referred to in this week's "Broadcast Brevities," Lionel Tertis will give a viola recital accompanied at the piano by Berkeley Mason.

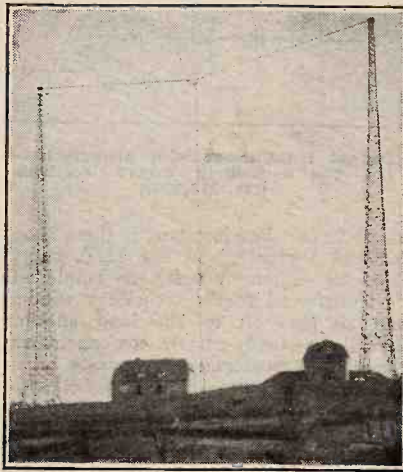

**HAMBURG'S SATELLITE.** Kiel, one of the four stations which relay Hamburg programmes. The wavelength is 246 metres.



# GRAMOPHONE

Stroboscopic Indicator  
for Use with A.C.  
Lighting.

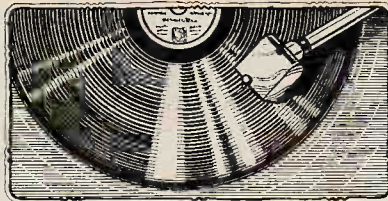

# SPEED TESTER

By  
H. LLOYD,  
M.Eng., A.M.I.E.E.

*This useful device has been accurately designed and affords a simple means of precisely checking the speed of a gramophone so that even a small error may be at once observed. The distorting effects produced by errors in the speed of rotation are explained. With the increasing use of electrical pick-ups where the load on the gramophone motor is uncertain the need for determining the rate of revolution of the turntable has become important.*

THE original sounds recorded on a gramophone disc can only be reproduced correctly when the turntable of the gramophone rotates at a uniform speed, and, moreover, only when its speed is exactly the same as that at which the record was originally cut. Uniformity of speed is essential, and can only be ensured by the use of a good motor, properly adjusted, whilst the rate of revolution is set by means of the governor of the motor.

A record which runs too slow or too fast will produce sounds which differ from the original in several ways. In the first place, it is obvious that the tempo of music will be altered, though a slight deviation in this respect would generally, in the absence of other effects, pass unnoticed. There also occurs, however, a change in the pitch, music being transposed into a higher or a lower key, according to whether the record is running too fast or too slow. These two effects are well known to every gramophone user, and are not infrequently employed with deliberate intention—as in the case of dance music, to suit the speed to individual requirements, and for purposes of study, to “tune” the gramophone to the same pitch as a piano or other instrument.

### Effects of Pitch Variations.

The divergence in pitch from that of the original performance may, however, produce decidedly undesirable effects. The pitch, or frequency, of every simple tone will be altered in the same ratio, and therefore a compound note, consisting of harmonic tones, *i.e.*, frequencies which are exact multiples of a fundamental, will be unaltered in quality. The simplest instance of this is the octave. An interval of an octave will remain an octave, whatever the speed of rotation of the record. All music, however, and especially that from some instruments, involves intervals which are inharmonic, and when these are modified by the speed of the gramophone,

the musical quality of the sound will be altered. The reaction of the ear to sounds is known to depend to a large extent upon the sensation due to subjective beat tones, and these will be altered when the notes combining to form them are changed in the same ratio, because the numerical difference, upon which a beat frequency depends, will no longer be the same. Transients in particular will be found to suffer to a marked degree.

This change in the quality of reproduced sounds occurs not only in music, but also in speech, and can

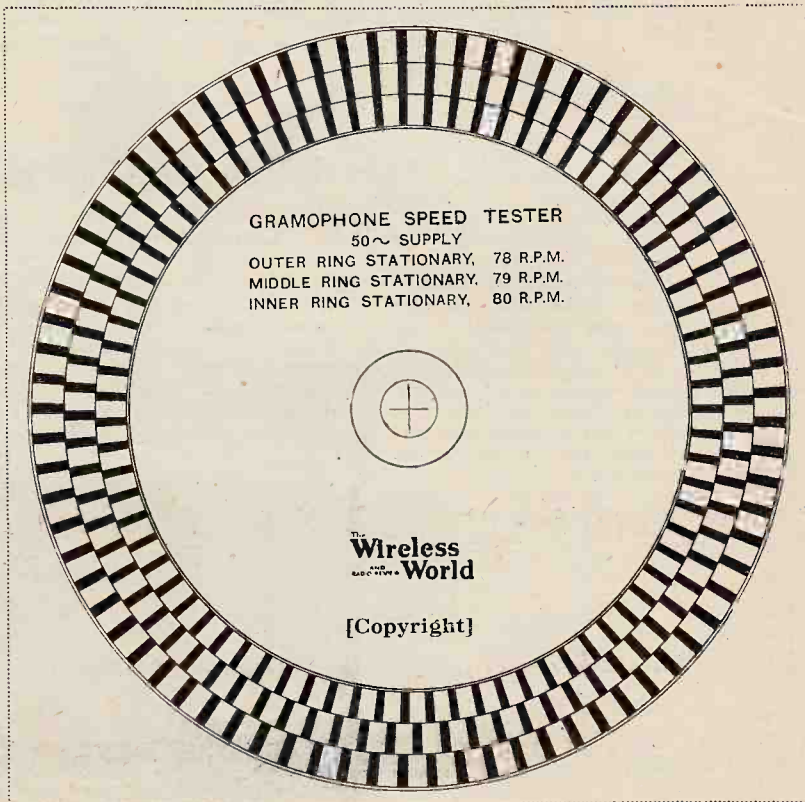

Paste the gramophone tester on to a piece of stiff card and carefully cut round the circumference. Punch a hole at the centre just large enough to admit the gramophone spindle. When placed on the revolving turntable and viewed by the light of a neon lamp connected to a 50 cycle A.C. supply the ring appearing stationary will indicate the running speed.

**Gramophone Speed Tester.—**

be demonstrated in a convincing manner even to an ear which is musically untrained by using a record of the speech of some well-known voice, such, for instance, as that of Sir Oliver Lodge. With the disc running a little too fast or too slow, the familiar tone of the voice becomes quite unrecognisable, altogether apart from the change in the speed of the discourse. That vowel sounds are modified can be shown by slowing down the record and listening for the *œ* sounds, which become *oo* quite distinctly.

All this serves to emphasise the point that the *quality* of sounds, as well as their pitch, may be affected adversely unless the motor speed is right. Most records bear the correct playing speed printed on the label, and this is usually either 78, 79, or 80 revolutions per minute. Except in the most expensive gramophones the speed indicator cannot be relied upon for great accuracy. Counting the revolutions of the turntable with the aid of a stop-watch is a simple but rather tedious process, but where alternating current lighting is available, there is an extremely convenient method, which depends upon the well-known principle of the stroboscope, of verifying the turntable speed.

If the accompanying illustration is pasted on to a piece of cardboard, and cut into a circular disc, with a hole punched in the centre having a diameter equal to that of the turntable spindle, it can be used as a quick

and accurate speed tester wherever there is A.C. lighting at 50 cycles frequency. Placing the disc on the turntable, and viewing it by the electric light as it rotates, the speed regulator of the gramophone is adjusted until one or other of the divided rings appears to be quite stationary, according to the speed requirements of the record to be played. If, for instance, 79 revolutions per minute is the desired rate, the middle one of the three divided circles is brought to rest by careful manipulation of the regulator. Under these conditions it is interesting to notice that the outer and inner rings appear to be slowly travelling round in opposite directions. The disc can also be used to detect any wavering in the speed of the turntable, and, since it is only four inches in diameter, it can be put on the top of a record whilst it is being played, to ascertain whether the load imposed by the pick-up is too great for the motor to handle satisfactorily.

The diagram illustrated is divided to suit a supply frequency of 50, which is rapidly becoming standard practice; any other frequency would require a different division of the circles. In cases where a pilot light is used in the instrument, just above the turntable for convenience in needle-changing, the substitution of a lamp of the Osglim neon-filled type shows up the stroboscopic effect very vividly, although it is sufficiently distinct enough for practical purposes with lamps of either the vacuum or half-watt variety.

*(The disc shown on the previous page has been reprinted in more durable form on white opaque paper. Applications for copies should be accompanied by a stamp for postage.)*

**B.T.H. ELECTRIC GRAMOPHONE MOTOR.****A Universal Machine Embodying Sound Engineering Practice.**

**T**HIS unit is of unusually massive construction and embodies the best engineering practice. Liberal use is made of aluminium alloy castings, and all bearings are of generous proportions. The main frame casting is mounted on rubber washers to absorb vibration.

The motor is of the universal type and can be used on either D.C. or A.C. mains. An adjustable resistance is provided so that the motor can be run off A.C. from 100 to 250 volts at 25 to 60 cycles, or D.C. from 50 to 250 volts—a range which covers most if not all the supply voltages available in this country. Measurements showed that the current consumption under load is of the order of 0.3 amp.

The drive is transmitted through a flat belt giving a reduction gear of approximately 4:1. The whole of the motor is mounted on swivel bearings and spring loaded to take up belt slack, the spring tension being adjustable.

Speed regulation is obtained by means of a conventional friction governor driven through a skew gear of composition material mounted on the turntable spindle. The speed of the turntable is therefore unaffected by belt slip, provided the power transmitted by the belt is in excess

of the power absorbed in the record. Correct adjustment of the spring tension will ensure the attainment of this.

Tests showed that the reserve of power is in excess of all normal requirements, while the speed of rotation is constant and maintains its setting over long periods. A comparison between a stan-

dard tuning fork and the constant frequency records is a searching test of this quality.

The accessories include a neat trip switch actuated by the tone arm, which automatically cuts off the motor current at the end of the record. The price of the complete equipment is £6 6s.

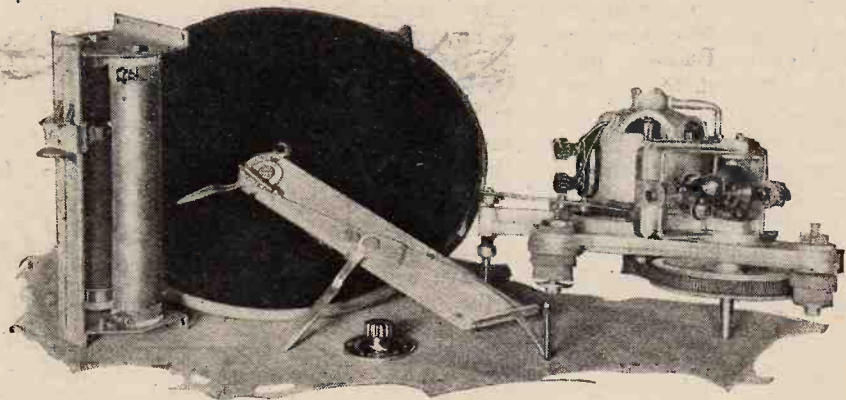

B.T.H. electric gramophone motor and accessories.

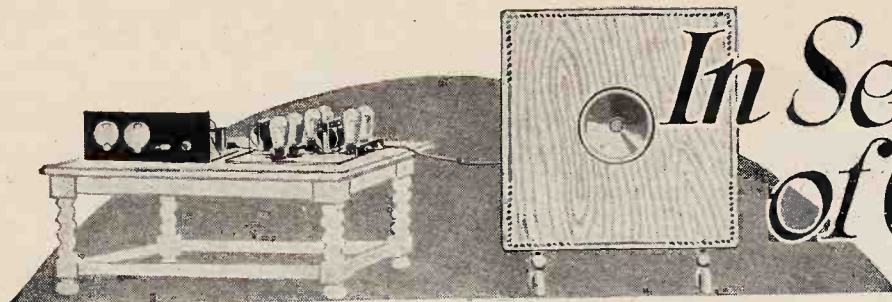

# In Search of Quality

## A Reader Tells His Own Story.

By BERTRAM MUNN.

MR. R. P. G. DENMAN'S article in your issue of July 31st on the performance of logarithmic horns of adequate length was indeed refreshing.

At the risk of being shot at dawn, I must confess being guilty of *lèse-majesté* to King Cone and Co.—that is, to the reed-driven and the moving-coil-driven Monarchs of the Wireless World (by which I do not refer to your excellent publication). King Moving-Coil has, of course, been the worse tyrant of the two, for he has been the more powerful and dogmatic. During the last few years he has slowly and ponderously thudded his way into our presence (both in the streets and at home) until the life of the more gentle listener-in has become a veritable nightmare of noise.

It is no longer enough to own a loud speaker which fills an ordinary room with crisp and soothing music and speech; the thing now is: Can it deliver the LOW NOTES? Can it deliver them at full volume? Can you feel the thud-thud of the 32-cycle organ note hit you in the solar plexus? Do you get notes—real, deep, he-man sort of notes—which not only move you to ecstasy but even move heavy articles of furniture, make the floor vibrate, and disturb the plaster on the ceiling? When some coloured jazz musician smites the big drum at Savoy Hill, does it hit *you* at Tooting, Balham, Bedlam, or wherever you happen to be listening-in? Does it make the grandfather clock wobble? Is the jazz orchestra going full blast in your own house? If all of these hectic things do not happen, then you do not know what modern reproduction is.

Should you have—in your humble and obscure way—a reed-driven cone.

you are a man to be pitied—one who lives in darkness, or, rather, in comparative silence. Should you have a moving coil without a baffle board as big as the side of the room, you are living in a fool's paradise devoid of those cherished depths to which only a M.C. can descend. Even if you erect that terrific baffle board, or embed your loud speaker in the door or the wall of your private concert hall, you still cannot expect faithful results from your inadequate set. What? You have only *one power valve* in the last stage? No, even a super-power is insufficient. You want a carefully balanced crew of at least four—two push-pulling and two working in parallel.

Seeking to be modern, you pile valve upon valve, accumulators become useless, you resort to the mains, "juice" is poured through your set as though it were a miniature, electrically driven factory. And thus you become another lost soul who has been called to salvation. You thud. Your neighbour, hearing you, also thuds in due course. His neighbour, hearing him, becomes another convert to the band of thudders. And so the pounding and pounding of low notes goes on. It is literally contagious. The 32-cycle punch hits you—physically—and you fall for it.

If, like me, you have no cone, and you have no moving coil, you are anathema. What have you? What else *can* you have? You dare to whisper, simply and modestly, "just a little horn affair. . . ." The look of horror which sweeps over your interrogator's face is enough to make the strongest quiver.

And yet, Mr. Editor, here am I, hanging conservatively on to the old, old horn with which I be-



The author's 10ft. logarithmic horn speaker operating from a small reed-driven aluminium cone and mounted in an alcove to aid sound reflection.

**In Search of Quality.—**

gan imbibing sound waves when Edison's phonograph arrived and told me nasally that this was an "Edison Bell Record." When I say the old, old horn, I am, of course, guilty of poetic licence. Ordinary commercial horns are useless, except as examples of graceful curves and contortions, or as super ash-trays for cigar and cigarette ends. Long, long ago—back in the dark pre-cone ages—I decided that the only thing was to build one's own horn.

**Sound Likes the Straight Path.**

With the aid of endless penknives, safety-razor blades, oceans of glue, strips of all sorts and thicknesses of wood, and an extensive vocabulary of "cuss" words, I have built some dozen or so horns, varying from six to eleven feet in length. They have, however, all been straight and all have conformed—as really dutiful horns should do—to the logarithmic principle on which their lives are founded. It was clear from the first, even to my untutored mind, that sound hates to go round corners or curves. Any modern gramophone will tell you this, and those whose horns fold beautifully and fearfully in and out of themselves will tell it you best of all. However good their intentions are as regards space, they are "boxey." The deep baritone who sings to you of one moonlit night in Venice is incarcerated in a tub, a barrel, or some sort of resonating chamber from which he cannot escape. He is badly hampered by not getting a straight run for his money.

Solidity is naturally another very important factor. Any energy wasted in vibrating the sides of the horn is nearly that much less energy available for disturbing the peace. I have never placed my present ten-foot loud speaker on one of those penny-in-the-slot weighing machines, but it would certainly register more than any one of my flesh-and-blood offspring. It is hefty; but then it has some hefty work to do. One cannot expect to get either reasonable volume or depth from a portable pocket trumpet, or a cone disguised as a lamp shade.

It possesses neither a bell nor a well-defined flare. Instead of being dependent on one of these monstrosi-

ties, it flings its waves against the rocks of a suitably disposed reflector, which links up with the two walls of the room and the ceiling. The landlord charges me no more rent for utilising a portion of his house as part of my loud speaker. The arrangement is thus very economical as regards space. Scientifically, I may have committed a terrible *faux pas* by dispensing with that vital and terrific mouth which a big horn should possess, if it is to eat up the really deep notes.

I have heard moving coils so often and read so much about the complex laws to which they should bend the knee, that modesty forbids my calling any home-made loud speaker perfect; but, so far, I prefer my old-world "trumpet arrangement" to any other loud speaker I have heard at work in the ordinary room of an ordinary house.

Until recently the unit was the great difficulty, but at the moment I am getting along quite nicely with a small, reed-driven, corrugated aluminium cone, which seems to be 50 per cent. more efficient than the best stalloy diaphragm unit. I use a modified Everyman Four receiver, with push-pull at the business end, and (in a room eighteen feet by twenty-one) I am able to get everything I want from a whisper, for restfulness, to a full-blooded orchestra, for those wilder moments when one must dance—or burst. But I cannot deliver thuds. I get all the low notes I want, and, above all, a crispness and brilliance—which I also want. No one who has heard the loud speaker has yet told me that he knows of a better one—which may be due either to politeness (for which wireless fiends are not noted) or to love of truth.

Thus do I remain faithful to my old love. I am, however, still awaiting the advent of a well-designed unit (which does not clamour for too much "juice"). When it arrives on the jaded market my ten-foot horn, realising its own worth, will give the newcomer a cordial welcome and will look down on the moving coil with even greater scorn than it does to-day.

I now resignedly wait for a party of moving-coil patriots to convey me to some quiet spot in Richmond Park—there to shoot me in the cold grey light of the dawn (which I hate even more than I do the moving coil).

*Ralph Stranger's Wireless Library* for the "man in the street":

No. 1.—**MATTER AND ENERGY.** The Chemical Elements. Structure of the Atom, Heat, Cold, Energy, etc.

No. 2.—**ELECTRIFIED MATTER.** Electrons, Distribution of Charges, Electric Fields, Discharges, etc.

No. 3.—**ELECTRONIC CURRENTS.** E.M.F. Ohm's Law, Alternating Currents, etc.

No. 4.—**MAGNETISM AND ELECTRO-MAGNETISM.** Permanent Magnets, Electro-magnets, Induction, Dynamos, Motors, etc.

No. 5.—**THE MATHEMATICS OF WIRELESS.**

No. 6.—**BATTERIES AND ACCUMULATORS.** Charging, etc.

Written in simple language for the instruction of the ordinary non-technical man. Each part comprises sixty-four pages with numerous illustrations and

## BOOKS RECEIVED.

diagrams. Published by George Newnes, Ltd., London. Price 1s. each part. Further parts in preparation.

*General Physics and Its Application to Industry and Everyday Life*, by Ervin S. Ferry, Professor of Physics in Purdue University, U.S.A. (Third Edition.)—A textbook for technical students comprising the Elements of Dynamics, Sound, Heat, Electricity and Light, with 1,634 Problems or Examination Questions relating to these subjects. Pp. 839+xix with 603 diagrams and illustrations.

Published by John Wiley and Sons, Inc., New York, and Chapman and Hall, Ltd., London. Price 20s. net.

*Reminders for Company Secretaries* (Fifteenth Edition), by H. W. Jordan.—Revised and rewritten for the assistance of secretaries of limited companies in view of the additional obligations imposed by the Companies Act, 1929, which came into operation on November 1st. Pp. 66+xxxii. Published by Jordan and Sons, Ltd., London. Price 2s. 6d.

*Photoelectric Cells, Their Properties, Use and Applications*, by N. R. Campbell and D. Ritchie.—A practical book explaining the theory and use of these cells and their application to Phototelegraphy, Television, Photometry, Absorption of Light, Colour Matching, etc. Pp. 209 with frontispiece and 41 diagrams. Published by Sir Isaac Pitman and Sons, Ltd., London. Price 15s. net.

# LABORATORY TESTS.

A Review of Manufacturers' Recent Products.

## WATES THREE-RANGE PANEL METER.

This measuring instrument provides a ready means of checking the H.T. and L.T. voltages, also the total anode current taken by the set. The three ranges read respectively 0-150 volts, 0-6 volts, and 0-30 mA. It is intended that the meter should be mounted on the panel together with an eight-socket range selector board supplied with each meter. By suitably interconnecting the sockets on this board the various ranges are brought into use. Two-pin plugs are supplied for this purpose. An illustrated leaflet explains clearly the correct method of wiring.

Two specimen meters were sent in for test, and measurements were made with these, using standard laboratory instruments to check their accuracy. The results are tabulated below.

Specimen I showed a maximum error of 5 per cent., and specimen II, 9 per cent.

On the 150-volt range the first-mentioned sample showed a maximum error of 4.4 per cent. and the second 6 per cent. This error appeared at the 50-volt mark, the meters showing greatest accuracy between 100 volts and 150 volts.



Wates panel-mounting meter and range selector board.

The first specimen had a resistance of 32.5 ohms per volt on the 6-volt range and 32.8 ohms per volt on the 150-volt range. In the case of the other sample the resistance was 33.3 and 33.6 ohms per volt respectively. These values are ad-

mittedly low, particularly for an H.T. voltmeter, and the instrument should be used only for making check readings, and not left permanently in circuit.

The makers are the Standard Wet Battery Co., 184-8, Shaftesbury Avenue, London, W.C.2, and the price, complete with accessories, is 13s. 9d.

o o o o

## "SHAKEPROOF" LOCK WASHERS.

Special washers provided with teeth which grip firmly the locking nut and the assembled parts have been in use in

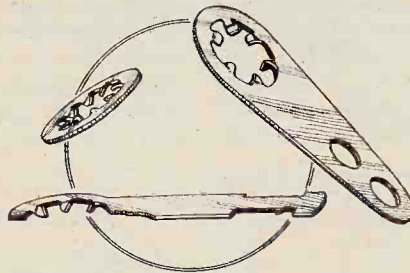

Examples of "Shakeproof" lock washers and terminal tags.

the U.S.A. for some time past, and are now to be introduced into this country. Messrs. Barber and Colman, Ltd., Brooklands, Manchester, have acquired the sole manufacturing and selling rights for Great Britain. Some early samples of these devices have been sent to us for review. These consist of lock-washers and special terminal tags. It is claimed that they will withstand shock and vibration and will not loosen. Those who have had much experience with nut and washer connec-

tions will appreciate the advantages of a sure and certain contact of this nature.

The locking washers have twisted teeth set at equal intervals around the internal edge. When the nut is tightened these teeth bite into both surfaces between

which it is placed and form a positive locking arrangement which is shake-proof.

Locking teeth similar to those on the washers are provided on the inside edges of the holes in soldering tags. The samples sent in are for use on 2- and 4-B.A. stems, but, no doubt, other sizes are available.

So far we have not been notified of the prices for these, and interested readers are referred to the manufacturers for this information.

o o o o

## "CLIMAX" RESISTANCES.

The "Climax" potential divider, which readers may recall was hitherto wound on a grooved wooden former, thus dividing the whole into sections of equal resistance, has recently been re-designed.

Sectionalised winding is retained but the sections are of unequal resistance value, having been chosen to give more convenient voltages at each tap. A grooved paxolin former is used now in place of the earlier arrangement. The nominal value is 20,000 ohms; its measured resistance was found to be 19,400 ohms. The largest section was 22 per cent. of the total resistance, the other sections varying from 7 per cent. to 10 per cent. of the whole. The price remains at 5s.



Climax 20,000-ohm wire-wound potential divider and 600-ohm decoupling resistance.

An addition to their range of components takes the form of some wire-wound decoupling resistances. The wire is wound in a groove on a former the size of a halfpenny in diameter and equal to three in thickness. So far these are supplied in values of 600, 10,000 and 25,000 ohms. A 600-ohm sample was measured and found to have a resistance of 646 ohms. The price is 2s. in each case. The makers are the Climax Radio Electric, Ltd., Haverstock Works, Parkhill Road, Hampstead, London, N.W.3.

Scale.	0-30 mA. Range.		Scale.	0-6 Volt Range.	
	True Current.			True Voltage.	
	Specimen I.	Specimen II.		Specimen I.	Specimen II.
5 mA.	5.2 mA.	5.45 mA.	1 volt	1.02 volts	
10 "	10.5 "	10.8 "	2 volts	2.05 "	
15 "	15.2 "	15.2 "	3 "	2.98 "	
20 "	19.9 "	20.2 "	4 "	3.9 "	
25 "	24.8 "	25.1 "	5 "	4.85 "	
30 "	29.5 "	30.0 "	6 "	5.72 "	



## Part XVI.—Resonance in Parallel Circuits.

By S. O. PEARSON, B.Sc., A.M.I.E.E.

(Continued from page 24 of previous issue.)

CONSIDERATION must now be given to another kind of tuned circuit, differing in several ways from the ordinary series or tuned grid circuit considered in the two preceding instalments. This is the parallel type of tuned circuit where the condenser and coil are connected in parallel with respect to the E.M.F. applied to the circuit. The condenser is connected across the coil and the alternating E.M.F. is applied to the ends

From Fig. 1 (b) it is quite clear that no E.M.F. is induced into the closed circuit, but that a voltage is applied between the ends A B. Under these conditions the behaviour is entirely different from that of the series circuit or tuned grid circuit, and so before we can deal intelligently with a tuned anode circuit and see what factors make for the highest efficiency, it will be necessary to investigate the general properties of the parallel circuit.

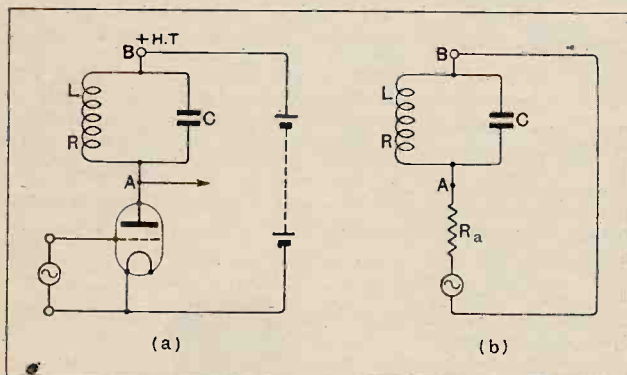

Fig. 1.—(a) Ordinary tuned anode circuit of high frequency and (b) the equivalent simplified circuit.

of the circuit, that is, across it, and not introduced into the closed circuit.

The commonest example of the parallel type of circuit is afforded by the ordinary tuned anode high-frequency intervalve coupling of a high-frequency amplifier valve, as indicated in Fig. 1 (a), where L R C is the tuned circuit. When an alternating voltage is applied between the grid and filament of the valve, a corresponding voltage, several times greater than that applied to the grid, is set up in the anode or plate circuit, and this drives an alternating current between +H.T. terminal and the filament of the valve, the circuit being completed through the high-tension battery. The part of the circuit between the anode and filament has a high resistance, being the internal resistance (so-called impedance) of the valve itself. Hence the complete anode circuit is electrically equivalent to the simplified circuit of Fig. 1 (b) where  $R_a$  represents the valve resistance and  $E_a$  the voltage "generated" in the anode circuit by the action of the valve. The D.C. voltage and current due to the H.T. battery play no direct part and do not affect the properties of the tuned circuit.

## Simple Parallel Circuit Without Resistance.

Consider a circuit such as that shown in Fig. 2 (a) where a condenser of capacity  $C$  farads is connected across a coil whose inductance is  $L$  henrys. An alternating voltage whose R.M.S. value is  $E$  is applied to the ends A B of the circuit and thus drives a current through each branch.

It will simplify matters a great deal to assume in the first place that the coil has no resistance whatever, find the conditions obtaining at resonance, and then consider the effects of resistance afterwards. It should be noted that for a parallel circuit the applied voltage is common to all branches and a separate current flows through each branch and can be calculated, if the voltage is known.

So in our imaginary perfect circuit of Fig. 2 (a) the current through the coil will be  $I_1 = \frac{E}{2\pi f L}$  amperes where  $2\pi f L$  is the reactance of the coil in ohms,  $f$  being

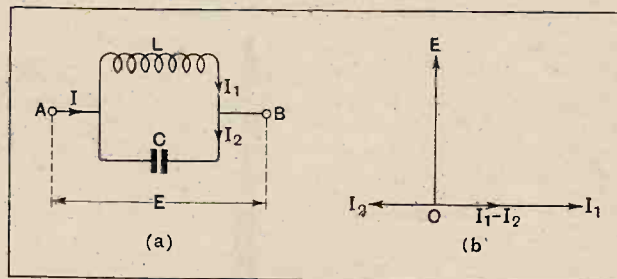

Fig. 2.—(a) Parallel circuit assumed to possess no resistance. (b) Vectors showing the phase relationships of the three currents  $I$ ,  $I_1$  and  $I_2$ .

the frequency. This current  $I_1$  lags behind the voltage by a quarter of a cycle. In the same way the current through the condenser branch will be  $I_2 = 2\pi f C \times E$

**Wireless Theory Simplified.—**

amperes, where  $\frac{I}{2\pi fC}$  ohms is the reactance of the condenser. This current leads the voltage by a quarter of a cycle. Hence if the line O E in Fig. 2 (b) represents the voltage applied to the circuit,  $OI_1$  will give the current in the coil, lagging by  $90^\circ$ , and  $OI_2$  the current in the condenser branch, leading the voltage by  $90^\circ$ .

Now, since  $I_2$  is a quarter of a cycle ahead of the voltage and  $I_1$  is a quarter of a cycle behind, it follows that the two currents are out of step by just half a cycle—that is to say, they are in exact phase opposition. This means that whenever the current in the coil is flowing in the positive direction, say from left to right, the current in the condenser branch will be negative or from right to left in the circuit, and *vice versa*.

These conditions of phase opposition are clearly portrayed by the sine waves of Fig. 3, and it is the existence of this state of affairs that accounts for the peculiar properties of the circuit. Note that each current is out of step with respect to the voltage by a quarter of a cycle. It means that the two currents  $I_1$  and  $I_2$  are always flowing in opposite directions with respect to the external circuit or source of supply, and so partly neutralise each other in the external circuit if they are unequal. Since the two current waves are in direct opposition the resultant current  $I$  taken from the source will be simply the numerical difference between  $I_1$  and  $I_2$ . So  $I = I_1 - I_2$  amperes or  $I_2 - I_1$  amperes, according to which is the larger.

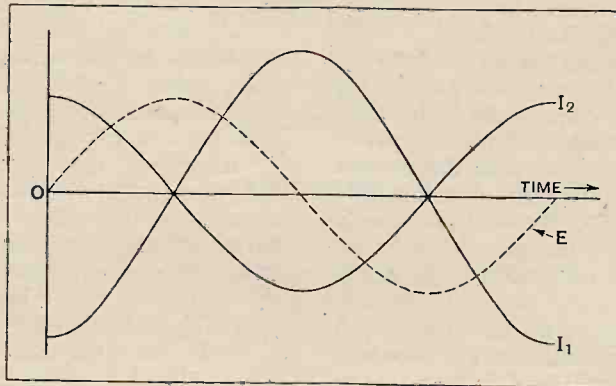

Fig. 3.—Curves showing that the current  $I_1$  in the coil is in direct opposition to current  $I_2$  in condenser. Each current is out of step with respect to the voltage  $E$ .

**Conditions for Resonance.**

Imagine now that the frequency of the voltage applied to the circuit is varied from a very low value to a very high value. The current  $I_1$  taken by the coil is inversely proportional to the frequency, whereas the current in the condenser branch is directly proportional to the frequency. Hence as the frequency is raised the current taken by the coil will start from a high value and fall, whilst that taken by the condenser will build up from a very low value to a high value. This means that at low frequencies  $I_1$  is greater than  $I_2$ , and at high frequencies  $I_2$  is greater than  $I_1$ . Hence there must be one particular frequency for which the currents in the branches will be equal, and this is the resonant frequency of the circuit.

For complete resonance, then, we have  $I_1 = I_2$ , or  $\frac{E}{2\pi fL} = E \times 2\pi fC$ , whence  $(2\pi f)^2 = \frac{I}{LC}$  or  $f = \frac{I}{2\pi\sqrt{LC}}$  cycles per second, being exactly the same as for the series circuit considered previously.

**The Oscillating Current.**

Now, since the current  $I$  in the external circuit, drawn from the source of supply, is equal to the numerical

difference between the currents  $I_1$  and  $I_2$  in the branches, and since these two are equal at the resonant frequency, it follows that when a circuit like this, having no resistance, is tuned to complete resonance, it takes no current whatever from the source of supply, because  $I_1 - I_2 = 0$ . Yet at the same time a considerable current, whose value is  $I_1 = I_2$ , will be flowing backwards and forwards round the closed loop L C of Fig. 2 (a). It constitutes a true oscillating current.

This might at first savour of the impossible. In practice the condition cannot be fully realised, because we cannot get a circuit without some resistance, but, as will be seen later, it is actually possible to arrange a circuit so that the current supplied to it is only a small percentage of that oscillating round the closed loop. If we could get a resistanceless circuit, however, a heavy oscillating current would be produced as explained, without any current flowing in or out at the ends of the circuit.

It might appear at first sight that we are getting energy from nowhere! But, of course, this is not the case, and the explanation of the behaviour of the circuit is fairly simple. It will be remembered that the average power

taken by a pure inductance and by a condenser was zero, and therefore once the oscillating current has been started, no further energy will be required to maintain it. This principle can be very clearly illustrated by a simple mechanical analogy: Suppose a heavy pendulum is suspended in a perfect vacuum on a suspension spring absolutely free from losses. When once such a pendulum has been set in motion it would go on swinging for ever without being driven. There is

nothing to stop it. (In practice the small losses in the suspension would cause it to come to rest after several hours.) The same conditions exist in our imaginary perfect circuit; there are assumed to be no losses whatever.

**Oscillation of Energy.**

Before considering a more practical circuit where resistance, and hence energy loss, is present, we must consider what is actually happening within the closed circuit itself; it is necessary to have a sort of mental picture of what is going on. Although no energy is coming in from the outside source it must be obvious that energy is stored within the fields of the coil and condenser at any instant, and that because nothing is coming in or going out the sum of the energy stored in the magnetic field of the coil and in the electrostatic field of the condenser must be a constant quantity.

Now the current round the closed loop is exactly a quarter of a cycle out of step with respect to the voltage across the circuit, and therefore when the current through the coil is a maximum the voltage across the condenser

**Wireless Theory Simplified.—**

is zero. Hence at this instant the magnetic field linked with the coil will have its greatest intensity, and there will be no lines of electrostatic force in the dielectric between the plates of the condenser. This means that the whole of the stored energy in the circuit is in the magnetic field of the coil at the particular instant considered, and the condenser carries no energy at all. If  $I_m$  is the maximum value of the current, the energy stored in the magnetic field is  $\frac{1}{2}LI_m^2$  joules at an instant when that in the condenser is zero.

Just a quarter of a cycle later the current will have fallen to zero, and the voltage across the condenser will be a maximum, and we find now that the whole of the energy is contained in the electrostatic field of the condenser, the magnetic field having fallen to zero. If  $E_m$  is the maximum value of the voltage, the energy stored in the condenser is  $\frac{1}{2}CE_m^2$  joules, as explained in a previous section.

Now as we have seen that no energy is coming into the closed circuit, and neither is any being lost as heat (heat can only be generated in a resistance), it follows that during the quarter of a cycle considered *the whole of the energy originally possessed by the magnetic field of the coil has been transferred to the condenser*, there being no loss and no gain. During the next quarter cycle, when the voltage again falls to zero and the current builds up to a maximum in the opposite direction, the energy is transferred back again to the field of the coil. So every quarter-cycle there is a complete interchange of energy between the coil and condenser. The whole principle of action of a tuned circuit pivots on the fact that the condenser is always giving up its energy when the magnetic field is being established and is therefore calling for energy, and *vice versa*. *In a circuit tuned to resonance, then, energy is being oscillated backwards and forwards between the coil and the condenser.*

**Comparison with Mechanical Oscillations.**

It is here that a mechanical illustration will assist materially in obtaining a clear conception of what is occurring in the resonating circuit. It will be remembered that inductance was likened to the inertia or mass

of a material body, and that the reciprocal of capacity was compared with the stiffness or elasticity of a spring (see page 600, November 27th issue).<sup>1</sup> Now if a weight  $W$  is suspended on the end of a vertical spiral spring rigidly fixed at the upper end, as shown in Fig. 4, and if the weight is then pulled downwards a short distance and released, it will continue to oscillate up and down. If the whole contrivance were enclosed in a perfect vacuum to eliminate air resistance, and if there were no energy losses in the spring itself, the oscillations would continue indefinitely without any further supply of energy from an external source. In a similar way the electrical oscillations in the resistanceless tuned circuit maintain themselves, once they have been started, without drawing any further energy from the source.

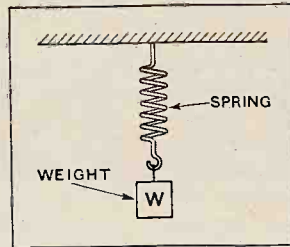

Fig. 4.—Weight and spring arrangement for illustrating electrical oscillations in a tuned circuit.

When the weight  $W$  is pulled down initially, energy is imparted to the spring in extending it. When the weight is released it is accelerated upwards by the pull of the spring and energy is transferred to it from the spring, being converted into energy of motion, or kinetic energy. At the instant the weight has reached its original position it has acquired considerable velocity,

the whole of the energy having been given up by the spring. Owing to its momentum the weight continues to move upwards and compresses the spring, which now retards the weight until it brings it to rest once more, and then accelerates it downwards again. When the weight is at its highest or its lowest point the whole of the energy is contained in the spring, whereas in the mid position, where the velocity is greatest, the energy is all kinetic and within the weight.

It will thus be seen that the energy is oscillating backwards and forwards between the weight and the spring in exactly the same way that the energy in the tuned circuit oscillates between the condenser and the coil.

The formula for the frequency of oscillation of the spring and weight is also of exactly the same form as that for the resonant frequency of the tuned circuit.

<sup>1</sup> Erratum: The 9th line of column 2 on page 600 should read:—" . . . that  $\frac{1}{C}$  in the one case corresponds to  $S$  in the other "

(To be continued.)

**Swiss Amateurs.**

The Radio Club of Zurich is transmitting telephony tests on 42 metres from its station HB9D at 33, Spyristr. on the first and third Saturdays of each month between 13.00 and 20.00 G.M.T. and will welcome reports from Great Britain. Our Zurich correspondent, who sends this information, states that British amateur stations as a rule are received there very clearly, and he especially mentions G5JO, an amateur station at Cambridge.

**A Correction.**

A correspondent has drawn our attention to an error in the call-sign of the

## Transmitters' Notes.

Barcelona station, as printed in our list of short-wave broadcasting stations on page 595 of our issue for November 27th. This should read EAR 25 instead of EAJ 25; the latter was the call-sign of the Malaga Broadcasting Station which is now closed down. EAR 25 is controlled by the Radio Club of Cataluña.

**New Call-Signs and Changes of Addresses.**

- G2FS L. K. Winsor, 375, Hessele Rd., Hull.
- G12KN B. McCann, 104a, Divis St., Belfast.
- G2XS H. W. Sadler, "St. Raphael," Anston Ave., Workop, Notts.
- G5CB Capt. K. Hartridge, 2, Westbourne Crescent Mews, London, W.2. (Change of Address.)
- G5DK J. S. Dykes, Thorncliff, Skelmorlie, Ayrshire.
- G5VA J. Wright, 13, New St., Ball Green, Stoke-on-Trent.
- G5ZN P. Nicoll, 167, Tomorden Rd., Burnley, Lancs. (Transmits on 7,146 kC. and 14,060-14,340 kC. and will welcome reports.)
- G6IO T. Woodhouse-Rayner, 25, The Gardens, London, S.E.22.
- G6TZ W. R. Bottomley, Providence Electrical Works, Luck Lane, Marsh, Huddersfield. (Change of address.)



# New Method of Detection using A.C. Valves

Tests of the Marconi and Osram MHL4 and ML4 Valves.  
The MHL4 as a Grid Detector.



**W**E have become accustomed to consider the leaky grid detector as a valve with an applied anode voltage of but 60, capable of handling rather less than one volt (R.M.S.) signal input. In these circumstances with the usual values of grid condenser and leak there has been a certain amount of high-note loss. With 240 volts. H.T. and modified grid circuit constants it is shown in the accompanying article that a valve such as the MHL4 when used as a grid detector can accept quite large inputs and give an output of a quality better than the best that the anode rectifier can produce. For local station reception where loading of the input circuit is of little consequence this new form of detection should be of great interest.

**I**N *The Wireless World* for January 26th, 1927, there appeared a review of the Marconi and Osram K.L.1 valve, which was the first indirectly heated mains valve that was introduced in this country. It was nearly a year before any competitor appeared to challenge its position as the only valve suitable for heating from alternating-current mains. We were therefore particularly interested in being able to examine the latest indirectly heated valves of the Marconi and Osram Companies.

The new series consists of four valves in all, one of which is a screen-grid valve, the other three being triodes of varying amplification factors. The two that we have had under examination are the low and medium-impedance triodes, known as the ML4 and the MHL4 respectively. The description of the valve is not arbitrary, but expresses its functions; M stands for "mains," L and HL indicate low and medium impedance, while 4 is the voltage required for the heater, at which voltage the current drawn is one ampere, the modern standard consumption for valves of this general type. Since the ampere in question comes from the mains, there is no need to attempt economy in consumption, with the result that the valves have a higher efficiency than is usual with battery-heated valves—a desirable feature which is accentuated by the fact that, as the emit-

ting surface does not carry current, it is at the same potential throughout its length. The whole of it—and not, as in battery-heated valves, a part only—is therefore effective in providing electrons for the plate circuit.

#### Construction.

Perhaps the most noticeable feature about the valves of this series, as compared with other mains valves, is their small size. Most A.C. valves are very decidedly larger than those intended for battery operation; the Marconi and Osram M valves are larger than the HL 610 of the same make, but smaller than the DE5A. A second unusual feature is the material of which the plate is made; this is not the sheet of metal that we have become accustomed to expect, but a piece of metal gauze instead. We suspect that this is meant to keep the grid of the valve cool, and so to help towards preventing grid emission, which is always difficult to avoid in mains valves. If this is the purpose of the gauze plate, it has achieved its object; no one of the four separate valves examined showed any reverse grid current, though half a micro-ampere would have been easily detected with the instrument used. The absence of reverse grid current also shows the valves to be absolutely hard.

#### The ML4.

The ML4 valve is modestly described as a "general-purpose"

valve, but as it has an impedance of no more than 3,000 ohms, and will run quite happily with a plate-current of 19 milliamps. at 200 volts, we feel that this description errs on the side of understatement. In a battery-heated series, such a valve would probably be called a "super-power" valve; it is adequate to run a moving-coil loud speaker at quite respectable strength. If greater power is needed, the ML4 may be followed by a valve of the LS5 class, for which it will easily provide the very large grid swing required.

The maker's rating of the valve is as follows:—

A.C. resistance	3,000 ohms.
Amplification factor	6
Mutual conductance	2.0 mA. per volt.
<small>(Measured about anode volts 100, grid volts 0.)</small>	

Both the samples we tested, which were practically identical, had the stated mutual conductance, but were a shade lower both in A.C. resistance and in amplification factor than the rated figures. The deviation is too small to signify, and low impedance is a virtue in a valve rather than a vice. Curves, on a large scale, are given for one of the valves, and the best working conditions, as determined from these, is very close to the suggestions made by the makers on their instruction sheet. Taking their advice, and adjusting the grid-bias to provide the current they mention as desirable for each value of plate voltage, we should

**New Method of Detection Using A.C. Valves.—**

suggest the following working conditions:—

Anode Voltage.	Grid Bias.	Anode Current.
100	10½ v.	10 mA.
120	12 v.	13 mA.
160	19 v.	16 mA.
200	23 v.	19.5 mA.

At the full 200 volts, the maximum anode voltage permitted, the valve will provide about three-quarters of a watt of undistorted power for the loud speaker. In watts this does not sound much, but it makes noise enough, when a reasonably sensitive speaker is used, to make conversation difficult in an ordinary room.

In addition to its possibilities in the output stage, the ML4 may be used as a detector or as a low-frequency amplifier. Supplied with very strong signals (about 15 to 20 volts R.M.S.) it would make a first-rate anode-bend detector for a

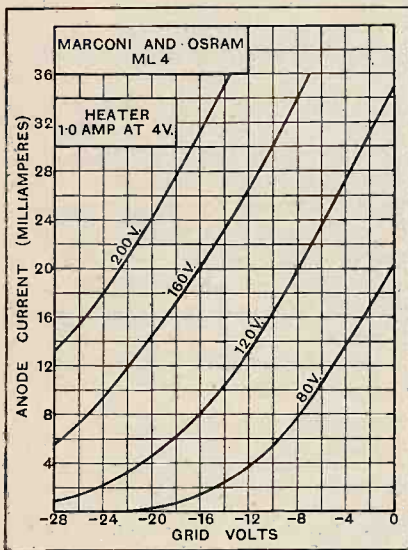

Grid voltage-anode current characteristics of the Marconi and Osram ML4 valve. Grid current starts at minus 0.4 grid volts. The measured A.C. resistance and amplification factor were 2,600 ohms and 5.2 respectively, giving a slope of 2.0 mA per volt.

“ quality ” receiver. If followed by a transformer it would give very adequate reproduction of low notes, though it would be necessary to arrange a resistance- or choke-feed to prevent the heavy plate current from passing through the primary. The same precaution would be required if the valve were in use as a low-frequency amplifier.

**The MHL4.**

The maker's rating of this valve is as follows:—

A.C. resistance	8,000 ohms.
Amplification factor	16
Mutual conductance	2.0 mA. per volt.

Both the valves tested had a higher mutual conductance than the nominal value, the amplification factor being a shade lower, and the A.C. resistance a good deal lower than stated. Curves are reproduced herewith to enable the anode current at different voltages to be estimated.

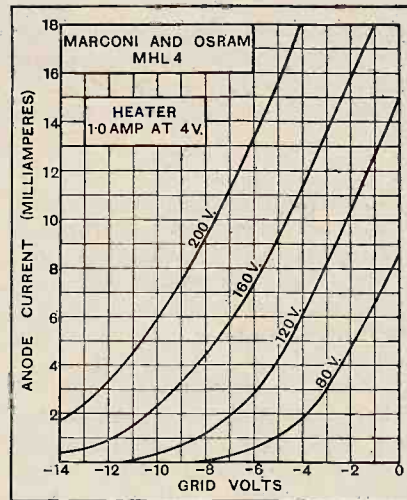

Measured characteristics of the Marconi and Osram MHL4 valve. Grid current starts at minus 0.75 grid volts. The A.C. resistance is 6250 ohms and the amplification factor 15, giving a slope of 2.4 mA per volt.

This valve is a very welcome addition indeed to the range of mains valves, for it fills a gap that has long been in existence between the high-impedance and the low-impedance mains valves. It is particularly suited for use as a rectifier, whether on the anode-bend or leaky-grid principle, and is equally serviceable either with resistance or transformer coupling in the low-frequency amplifier. Once again, a transformer should be resistance-fed unless its primary is capable of retaining a high inductance with some eight or ten milliamps. passing through it. In a resistance amplifier the MHL4 should combine good amplification with very perfect reproduction, especially of the high notes. A resistance of some 20,000 ohms is suggested as suitable for this purpose.

In the course of a recent conversation with Mr. Denman, who is designing a new demonstration receiver for the Science Museum, we were shown some rectification curves of a somewhat similar valve. We were therefore interested to examine the suitability of the MHL4 for use as a distortionless grid rectifier. A curve connecting input A.C. voltage with rectified output voltage is given herewith, and it will be seen that this curve is most gratifyingly straight over most of its length. With an input of 2.75 volts (R.M.S. signal voltage) rectification introduces no harmonics whatever until the modulation approaches 80 per cent., and the output of rectified signals, on average modulation, is in the neighbourhood of 8 volts or so. This implies a quality better than the best that the anode rectifier can give; the diode rectifier itself, which is taken as the standard for quality, can do very little better. The conditions under which the measurements were made is given in

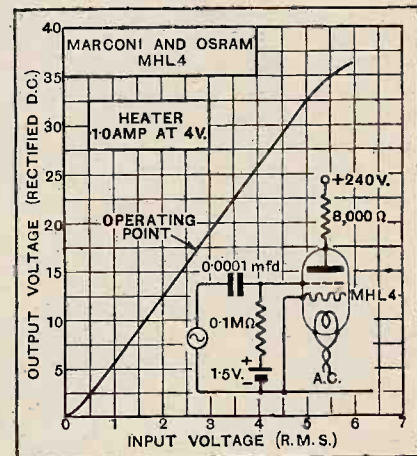

The distortionless curve of the MHL4 valve used as a “ power ” detector working on the leaky-grid principle. The circuit constants are given. The anode current is 14 mA. and the change in current on tuning in the signal is 2 mA for optimum rectification.

the figure, so that immediate use may be made of the data by those who may be interested. The comparatively high anode current (14 milliamps.) would be hardly likely to shorten the life of the valve, since its maximum watts dissipation is 4. In any case the writer proposes to use it in a set destined for local-station reception.

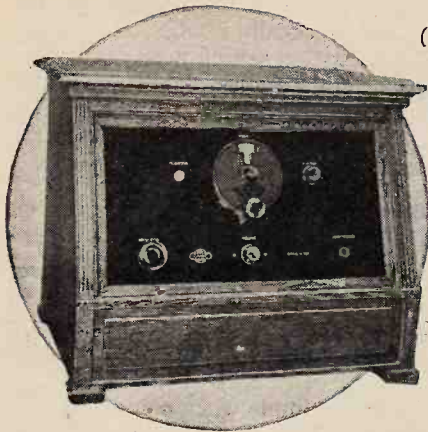

# BROADCAST RECEIVERS

## IGRANIC NEUTROSONIC SHORT WAVE SET

A Successful Application of the Superheterodyne Principle to Short-wave Reception.

THERE is nothing essentially novel in the idea of applying the superheterodyne principle to short-wave reception: In the days when direct H.F. amplification below 600 metres was attended with considerable difficulties, the superheterodyne was employed to convert the incoming frequency to a value which would be successfully amplified with known methods. Although we have solved the problem as far as the 300-500-metre band is concerned, H.F. amplification on wavelengths below 100 metres stands much in the same position as did the 300-500-metre band, say, five years ago. It is therefore only logical to apply the superheterodyne principle until such time as we can obtain stable H.F. amplifications of 100 per stage or more below 100 metres.

It is one thing, however, to decide that this principle is desirable in theory, and another to put it into practice. Those who have had practical experience of reception below 100 metres will appreciate that it is extremely difficult to control the very high frequencies involved. The smallest stray capacities afford an excellent path for currents of the order of 10,000,000 cycles, and it is exceedingly difficult to prevent these wandering into the intermediate amplifier and other places where they are unwanted, particularly when a part of the receiver is itself oscillating at a frequency close to that of the input. In the Igranic set all these various frequencies would appear to be well under control, for the set functions rationally down to 15 metres, and is as easy to control as a broadcast

receiver. There is a notable absence of hand capacity and "threshold howl" near the oscillation point occurs only in the last few degrees of the lowest wave-range.

### Advantages of Aperiodic Aerial Circuit.

The circuit employs six valves in all with 4-volt filaments. The first, a P.M.14 screen-grid valve, performs the dual function of H.F. amplifier and aerial coupler. It will be seen from the schematic circuit of Fig. 1 that the input voltage from the aerial is developed across a high-frequency choke H.F.C.1 between grid and filament of the H.F. valve. The resonant frequency of this choke is well above the longest wavelength the set is designed to receive, and the aerial circuit is therefore aperiodic throughout the whole range of the set (12.5 to 70 metres). Obviously, the voltage developed across the choke is much less than would be obtained with a tuned circuit, but this is compensated for by the amplification of the screen-grid valve. The input to the first

detector is therefore about the same as would be obtained with a good tuned circuit, but the choke-valve coupling has three distinct advantages over the more convenient method.

It is well known that harmonics in the aerial system are a frequent source of trouble in short-wave reception. In the conventional reacting detector - L.F. set these harmonics are one of the causes of blind spots where an abnormal degree of reaction is required to produce oscillation. The consequences in the case

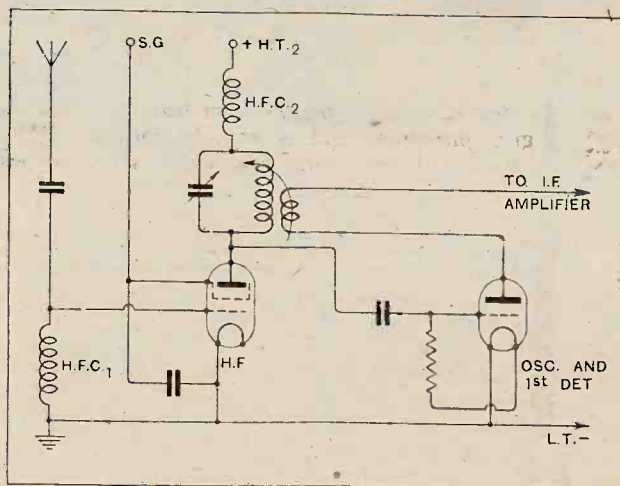

Fig. 1.—Schematic diagram of connections of the first two valves in the Igranic Neutrosonic Short Wave receiver.

**Broadcast Receivers.—**

of a superheterodyne would be even more serious, as the aerial load would damp out the local oscillator, and if the power of the latter were increased to overcome this difficulty, the oscillations would be too strong for efficient reception at other parts of the wave-range. In the Igranic set the screen-grid valve, with its low residual capacity, acts as an effective screen between the aerial and the oscillating detector, which is thus independent of variations in the aerial load. This arrangement confers the further advantage that the length of the aerial can be increased almost indefinitely without loading the set in any way. In addition, radiation due to the local oscillator is reduced to a minimum, and, finally, a tuning control is eliminated, thus producing a one-knob set.

The single Indigraph dial and three-vane condenser tunes the anode circuit of the screen-grid valve, which is virtually the grid circuit of the combined first detector and oscillator. To this coil is coupled the reaction coil in the plate circuit of the detector. Both coils, which are of the standard Igranic plug-in type, are mounted in a two-way coil holder, the reaction coil being fixed and the anode coil variable through a slow-motion control on the front panel. Little change in the coupling between the two coils is necessary, however, and the setting is maintained over the greater part of each waveband. Four changes of coils are necessary to cover the full range of the set (12.5 to 70 metres) and there is considerable overlap between the wavebands associated with each pair of coils.

The oscillator and first detector (PM3) is followed by two intermediate-frequency amplifiers (PM3A) associated with a standard Igranic I.F. unit as used in Neutrosonic sets designed for ordinary broadcast reception. In the set submitted for test the measured wavelength of the I.F. amplifier turned out to be 6,250 metres. At first sight this would appear to be an unnecessarily high figure, having regard to the low wavelengths received. It has one advantage, however, in that two reception channels for any given station are not more than two or three degrees apart on the tuning dial and there is much less confusion in tuning than would otherwise be the case. The cost of the set would also have to be increased if a special amplifier of lower wavelength were introduced.

Reaction is introduced in the I.F. amplifier by means of a small variable condenser on the front panel. The

advantage of applying reaction in the fixed frequency amplifier is obvious; it is practically unaffected by alterations in tuning and the reaction setting need not be disturbed over wide sections of the tuning dial. There is also a volume control associated with the I.F. amplifier which takes the form of a high-resistance potentiometer in the grid circuit of the first I.F. valve.

**Hints on Operation.**

The second detector (PM3) is followed by a type "J" Igranic L.F. transformer feeding into a PM254 power output valve. The loud speaker is connected directly in the plate circuit and the volume is such that phones are unnecessary even when receiving the most distant stations.

The tuning is delightfully simple when compared with the usual reacting detector—L.F. short wave set. Having set the reaction control it is possible to go practically all round the dial, either with the receiver just oscillating for C.W. signals or just off the oscillation point for telephony. American stations have been picked up in this way without heterodyning the carrier wave at all. Right at the bot-

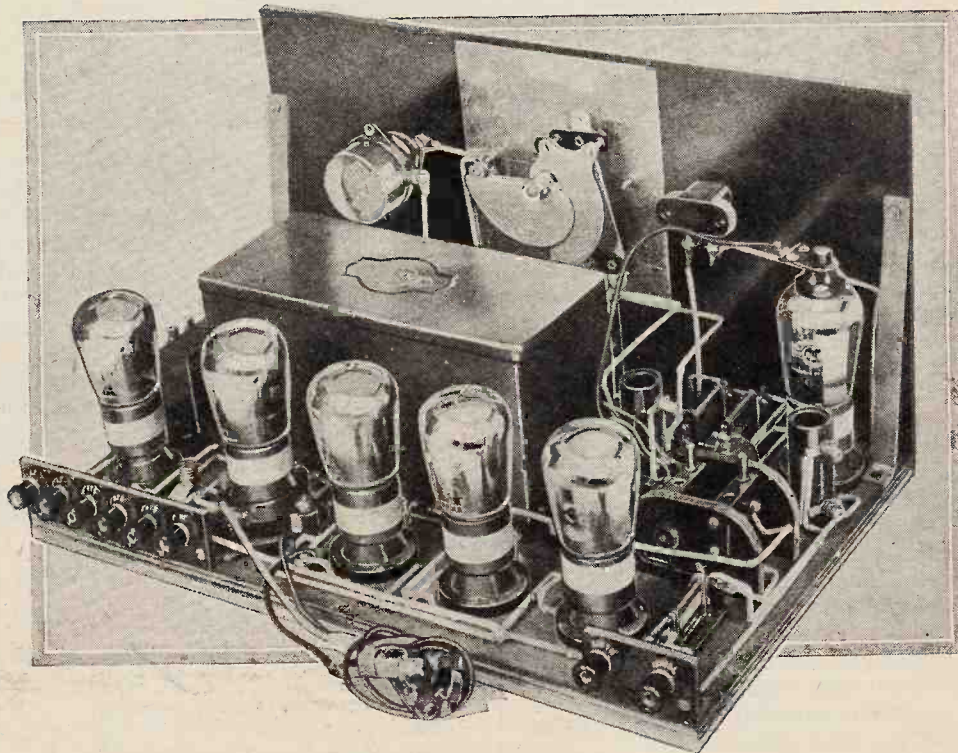

Igranic Neutrosonic Short Wave chassis removed from the cabinet. Note the I.F. amplifier unit and metal screen behind the tuning condenser. The short-wave plug-in coils have been removed to show the H.F. chokes associated with the aerial and screen-grid valve circuits.

tom of the wave-range, between 12.5 and 15 metres, there was a suggestion of threshold howl in the particular receiver tested but elsewhere the reaction control was smooth and free from backlash. The only precaution when tuning is to see that the first detector is kept in a continual state of oscillation. With the I.F. amplifier oscillating the detector oscillations may cease without being noticed as the I.F. amplifier may be already producing the breathing noise characteristic of oscillation. It

**Broadcast Receivers.**

was discovered in testing, however, that long-wave C.W. stations, due to direct pick-up in the I.F. amplifier, could be heard in the loud speaker when the first detector stopped oscillating. Normally these stations are inaudible, so that this effect is a useful reminder that the oscillator coupling must be increased. One soon learns the best average coupling for each pair of coils, however, and the "oscillator" knob needs adjustment only when coils are changed.

It would be impossible to give a complete list of stations received. On the two middle ranges there is a station—either C.W. or telephony—every two or three degrees on the dial and on each of the remaining two ranges there is enough material for several evening's work. The American end of the transatlantic telephone comes in well at all times of the day and night on one or

other of its alternative wavebands and the Eindhoven and German transmitters are always reliable. An evening was devoted to American broadcasting and six stations were logged at good loud speaker strength, including 2XAF, 2XBA, 3XAL and 8XK, the last two at full bore. The modulation from any of these stations could be easily found without once allowing the I.F. amplifier to go into oscillation.

As a result of more than a week's experience with this set we are of the opinion that it is definitely superior to any short-wave receiver having the conventional reacting detector circuit so far tested both on the score of range and ease of control. The price in oak, including valves, coils and royalties, but excluding batteries and loud speaker, is £28 and the makers are The Igranic Electric Co., Ltd., Bedford, and 147, Queen Victoria Street, London, E.C.4.

## Picture Reception in the Air.

### German Tests with the Fultograph.

OF what value are wireless pictures to the aeroplane traveller? This is the question that the Luft-hansa Company, of Berlin, recently set itself to answer, and the success of the experiments conducted is indicated by the announcement that it is intended to equip the company's machines with picture receivers for the reception of weather maps and aerodrome plans.

The aeroplanes are already furnished with up-to-date wireless apparatus—both for telegraphy and telephony—but there are grave limits to the amount of information which can be conveyed in a hurried Morse message or telephone conversation, especially in emergencies, and the new opportunities presented by the transmission of a picture or map capable of telling a long story at a glance are not to be neglected. It often happens that when a pilot encounters a storm belt he is quite ignorant of its extent and shape, and a blind attempt to fly round it may end in disaster. Here is a case in which a chart transmitted from the nearest meteorological station can be vitally useful. Again, during wet weather aerodromes may be flooded, or marshy patches may develop on which it would be unsafe to land. A picture transmission will at once indicate to the pilot what parts of the ground are still available.

The recent experiments were carried out on a

Lufthansa aeroplane in co-operation with the German branch of the Fultograph Company. The apparatus on the experimental plane consisted of a Fultograph with built-in rectifier, a type which has been on the market since the Berlin Wireless Exhibition. Use was made of the Telefunken receiver already installed in the aeroplane, but it is intended later to fit a special picture receiver designed for aerial service.

It is interesting to note that the operator finds it necessary to adjust the receiver from time to time to suit the direction of movement of the aeroplane with



The Fultograph receiver in use in a Lufthansa aeroplane. To prevent spilling, a sponge soaked in potassium iodide solution was employed in the experiments. On the right is the Telefunken transmitter and receiver.

**Picture Reception in the Air.**

respect to the transmitter. The Lufthansa aeroplanes are nearly all fitted with aerials consisting of a single wire let down from the machine, so that the aerial is inclined in a direction opposite to that of flight, and its direction with regard to the transmitter is always varying. This fact will have to be taken into considera-

The experiments are primarily concerned with the ultra-short waves, which the Lufthansa Company are especially anxious to introduce into their service on account of the very light weight of the apparatus involved. Tests have already been carried out on the Berlin-Königsberg air route, but unfortunately they have not yet pointed to the possibility of establishing a twenty-

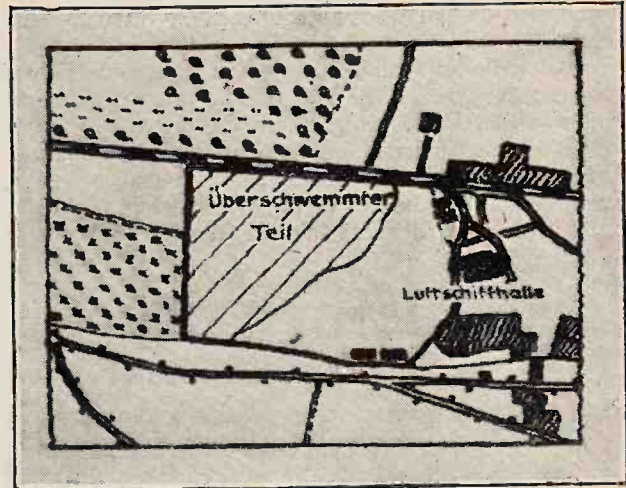

A sketch map transmitted to an aeroplane to indicate that a portion of the aerodrome was flooded and unsuitable for landing purposes. The original is shown on the left and the map as received on the right.

tion in designing the new picture receiver for aeroplanes.

Another field of research is being explored by the Lufthansa Co., viz., the use of short waves for aerial telegraphy and telephony. In this work the company is being aided by the combined firms of Telefunken and C. Lorenz, with the assistance of Professor Esau, of Jena, and the German Air Traffic Research Institute.

four-hour service. More recently attention has been turned to the Lübeck-Travemünde route, and a short-wave wireless equipment has been built into a Romar aeroplane. The results of these tests have not yet been published, but it is understood that the ultra-short waves are likely to prove of real value for aircraft navigation.

F. N.

## NEWS FROM THE CLUBS.

### Meetings Twice a Week.

The Kentish Town and District Radio Society commenced its new session on January 7th. New members are heartily welcomed. Meetings are held at 8 p.m. on every Tuesday and Friday at the Carlton Road Schools, Kentish Town, N.W. On Tuesday, January 14th, a lecture with lantern slides on the "Screened Grid Valve," prepared by the Marconiphone Co., Ltd., will be delivered. This will be the first of a series of three lectures. The Society caters both for novices and advanced amateurs. The keenness of its members can be gauged from the fact that bi-weekly meetings were held throughout the summer months. All enquiries should be addressed to the Hon. Secretary, Mr. A. H. Sartain, 40, Harrington St., Regents Park, N.W.

o o o o

### All About Mains Sets.

Mains units and their use with wireless receivers was the subject of a lantern lecture given by the Marconiphone Co. at a recent meeting of the Tottenham Wireless Society. Early difficulties met with in the design and satisfactory operation of mains sets, particularly in respect of the filament heating, were dealt with, and interesting details were given regarding the latest types of all-electric receivers. The lecturer gave valuable hints on the most suitable voltages and adjustment of grid bias.

Hon. Secretary, Mr. W. B. Bodemeaid, 10, Bruce Grove, Tottenham, N.

o o o o

### Mains Operation.

"Operation from A.C. Mains" was the title of a lecture given by Mr. Youle, B.Sc., A.C.G.I.,

A.M.I.E.E., of the Marconiphone Co., at a recent meeting of Slade Radio (Birmingham). Commencing with the question of H.T., the lecturer gave useful information regarding rectification, valves, chokes, and smoothing circuits. The question of L.T. was next explained, and details were given of A.C. mains, valves, etc. A convincing demonstration was given of a Marconi four-valve set and moving-coil speaker, together with a new gramophone pick-up.

The Society offers exceptional facilities to those interested in wireless, and full information may be obtained from the Hon. Secretary, 110, Hillaries Road, Gravelly Hill, Birmingham.

o o o o

### Pick-ups on Trial.

A fascinating demonstration of various types of electrical pick-ups took place at the recent annual general meeting of the Croydon Wireless and Physical Society. Members formed the "jury" for the evening, and the results were interesting and instructive.

The next meeting will be held on the 20th January, when Mr. A. J. Webb will give a lecture on selectivity.

Visitors are heartily welcomed to the meetings. Particulars regarding membership may be obtained from the Hon. Secretary, Mr. H. T. P. Gee, Staple House, 51-52, Chancery Lane, W.C.2.

o o o o

### The Siemens Film.

A combined meeting of the Whitgift Middle School Wireless Society, the Thornton Heath Radio Society, and the South Croydon Radio Society will be held in St. Paul's Hall, Thornton Heath, on January 28th, when a cinematograph

film dealing with Messrs. Siemens' products will be the chief feature.

All wireless enthusiasts will be welcome.

o o o o

### Society Offers to Help.

That highly controversial question, the separation of 2LO's two wavelengths, was the subject of an open discussion at a recent meeting of the South Croydon and District Radio Society. Views on the subject were not lacking, for many members had them to air, and it soon appeared that the two transmitters were quite capable of being separated, but with precisely what type of set was debatable.

It was realised that the ever present "man-in-the-street" might be in difficulties if he did not possess a stage of high-frequency amplification. The majority of speakers agreed, however, that without a high-frequency valve it was still quite easy to perform the divorce of the two wavelengths, but then attention must be paid to the coils and tuning arrangements if reasonable results were to be expected. Some speakers insisted that at least two stages of high-frequency would be necessary.

The Hon. Secretary, Mr. E. L. Cumbers, 14, Campden Road, South Croydon, said that the Society was only too eager to get in touch with Croydon's wireless set owners who were troubled by the problem of selectivity, and he felt certain that as a result the Society could help them not a little. Indeed, he concluded, it was for matters such as this that the Society existed and it was essentially its duty to do all it could to ensure that the "man-in-the-street" received his alternative programme without trouble.

B 32

BROADCAST

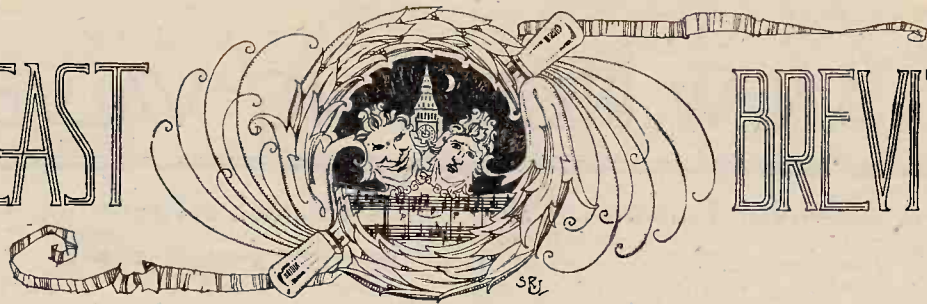

BREVITIES

By Our Special Correspondent.

**The Dominions and Empire Broadcasting.—“Go Home and Listen.”—Something for Everybody.**

**New Stimulus to Empire Broadcasting.**

How much longer is 5SW to be known as the “experimental short-wave transmitter”? Possibly the project for a permanent Empire broadcasting station will receive a fresh impetus on January 21st, when the speech of His Majesty the King at the International Naval Disarmament Conference will be sent out from Chelmsford primarily for reception throughout the Empire.

○○○○

**Cash from the Colonies?**

The B.B.C. can, I think, be spared any further criticism in the matter of Empire broadcasting, as the question is now in the hands of the Colonial Office. I understand that the Dominions and Colonies are now being canvassed for contributions towards defraying the expenses of a permanent service. His Majesty's speech will thus come at an appropriate juncture; the Dominions are sure to make a determined effort to hear it (as well as the speeches of the Dominion representatives on the Conference), and the degree to which 5SW can make itself heard on this occasion may directly affect the financial enthusiasm of its audience.

○○○○

**Pre-breakfast Enthusiasm.**

American keenness over the transmission is illustrated by the news that the National Broadcasting Company of America is arranging to relay the speeches through its chain of stations despite the fact that New York will hear the event at 6 o'clock in the morning!

○○○○

**Regional Developments in 1930.**

Several promising developments on the technical side should occur before we sing dirges for 1930. Everybody knows that twin programmes are to be expected from Brookmans Park, but nobody (no, not even the Chief Engineer himself) knows when.

After London Regional the next regional station to be officially constituted as such will be Daventry, the Midland Regional. The Northern Regional at Slaithwaite will begin testing by the autumn, but before then constructional work will have begun on the Scottish station at Falkirk and a site will have been chosen for the Western Regional in the Cardiff district.

B 33

**“Go Home and Listen.”**

I have already referred to the embarrassment of the Savoy Hill Programme Department when faced with an appeal for specially brilliant programmes in National Wireless Week, which begins on Sunday next, January 12th. The programme people felt it necessary to explain that all programmes nowadays are brilliant, so why gild the lily, etc. However, prodigious tearing of hair and burning of midnight oil have produced a bill of fare which is admittedly above the ordinary standard, and I would recommend everybody to follow the slogan of the week, viz., “Go Home and Listen.”

○○○○

**An Appetising Menu.**

Among the coruscating items must be mentioned the appearance of Madame Suggia in a 'cello recital from 2LO, 5XX

on Wednesday, a work in which Robert Louis Stevenson and his stepson, Lloyd Osborne, collaborated. And on Thursday we are to have “The Immortal Memory of Sir Walter Scott,” toasted by the Rt. Hon. Stanley Baldwin at the dinner of the Sir Walter Scott Club in Edinburgh.

○○○○

**Something for Everybody.**

A first-class symphony concert from the Queen's Hall, with Szigeti as solo violinist, the veteran Sir George Henschel singing to his own accompaniment, and two microphone appearances of Gracie Fields are among the additional attractions. So why stay out-of-doors?

○○○○

**That New Year Broadcast.**

Once again the B.B.C. “went all out” in its New Year celebrations. The idea of touring European cities was a good one, and was well carried out in spite of atmospheric. True, we had only a cough or two from Bratislava, but a cough from Eastern Europe is better than a paroxysm in the B.B.C. talks studio.

I listened to the “Grand Good Night,” or rather, part of it, *via* Hilversum. Eventually our Dutch friends gave up struggling with an alien tongue and broadcast orchestral music on their own account.

○○○○

**Where Opportunity Counts.**

America's latest record is that of a woman who listened to broadcasting continuously for “more than five days.” If the B.B.C. could be persuaded to broadcast continuously, the American record would probably be broken by the licence-holders of Aberdeen.

○○○○

**Things we Want to Know.**

Whether Big Ben is developing a bigger crack, or whether a new microphone is needed.

○○○○

**“Burns Nicht.”**

This year Mauchline will again be the stage for the broadcast celebration of the poet's birthday on January 25th. Instead of in Poozie Nansie's Inn, the microphone will be installed at Mossiel Farmhouse, outside the town, in which Burns wrote some of his best works. The celebrations will be broadcast from all stations except 5GB.

**FEATURES FOR NATIONAL WIRELESS WEEK.**

**London and Daventry (5XX).**  
 JANUARY 13TH.—Cello recital by Suggia.  
 JANUARY 15TH.—“The Wrecker,” play adapted from “R.L.S.”  
 JANUARY 16TH.—The Toast of “The Immortal Memory of Sir Walter Scott,” proposed by Rt. Hon. Stanley Baldwin, relayed from Edinburgh.  
 JANUARY 17TH.—Symphony Concert relayed from Queen's Hall.  
 JANUARY 18TH.—Running Commentary on Rugby Football Match, Wales v. England, S.B. from Cardiff.

**Daventry Experimental (5GB).**  
 JANUARY 12TH.—Oratorio programme.  
 JANUARY 16TH.—“Helmet and Haversack,” a Page of Military History.  
 JANUARY 17TH.—“As You Choose,” a reasonable Pantouque by Robert Rutherford.

**Cardiff.**  
 JANUARY 13TH.—“Mists of Sedgemoor,” a story of the Men of the West, by Dorothy Champion and David Thornton.

**Manchester.**  
 JANUARY 13TH.—“Cousin Sarah's Quilt,” a play of Lancashire life, by Florence Bone.

**Glasgow.**  
 JANUARY 14TH.—Folk Music of Caithness, Orkney and Shetland and Scottish Country Dances.

**Belfast.**  
 JANUARY 13TH.—Concert of First Prize Winners, North of Ireland Bands Association.

and other stations on Monday at 10.15 p.m. Those to whom radio drama appeals should not miss “The Wrecker”

# A NEW RECTIFYING VALVE

A Gas-filled Full-wave Valve with Remarkable Regulation Curve.

By E. R. DIETZE.

ONE of the features of the Berlin Wireless Exhibition was the great number of mains-operated receivers and power-amplifiers as compared with those operated from batteries. The latter have practically disappeared altogether from the German market. One of the reasons for the great popularity of the entirely mains-operated set is, of course, the fact that throughout Germany the mains are standardised to a far greater extent than in England, where any number of different A.C. and D.C. voltages exist, where even the cycles of the A.C. mains are not standardised, but vary between 25 and 100 cycles. Also, there are still large stretches of country without any electric power supply whatever, such stretches, however, being comparatively rarer in Germany. On the other hand, the development of efficient and inexpensive battery eliminators for the mains operation of receivers, power-amplifiers, and radio-gramophones, has been greatly facilitated by the fact that a certain type of full-wave rectifying valve of the gas-filled variety possessing most remarkable characteristics has been available for some length of time.

The Rectron valve, under which name it is known in Germany, is filled with a mixture of rare gases and mercury vapour at low pressure. The effect of the mercury vapour is to keep the internal resistance of the valve as low as possible. It is this negligible internal resistance which is the outstanding feature of this valve, so that the rectified D.C. potential is to all practical purposes the same even when the load on the valve changes by as much as 100 per cent. Naturally, this property is of great value in the design of battery eliminators; for instance, the pot winding of a moving-coil loud speaker may be energised from the rectifier supplying the high tension to the receiver if thought fit, without the potential dropping to any serious extent, or, in the case of the pot winding being disconnected, rising to a value liable to harm the valves in the receiver. Another great advantage is the negligible loss of energy across the internal resistance of the rectifier valve, which is quite a considerable per-

centage of the D.C. wattage delivered in the case of the more usual rectifier of higher internal resistance. Incidentally, of course, the valve is capable of handling very large power without undue development of heat, even although the electrodes are very small.

A full-wave rectifying valve of this design yielding 120 watts D.C. is no larger than an ordinary receiving valve of the super-power type. The most remarkable property of all, however, is that the same valve may be used for both low-tension work up to more than one ampere and high-tension work up to 500 volts, according to the A.C. potential applied to the plates. This makes it possible to combine an L.T. charger with an H.T. battery eliminator by simply changing over the plates of the valve to a low-tension winding on the mains transformer and applying the rectified potential to the L.T. accumulator on switching off the set. All these properties, of course, are the natural result of the negligible internal resistance of the valve due to the mercury vapour present.

### Low Internal Resistance Due to Mercury.

Considering this, it is remarkable that this valve is as suitable and as reliable for high-tension work as it has proved itself to be, the largest of these valves at present available handling 1,200 volts and 300 mA of D.C. output with ease and safety. A complete range for all low- and high-tension requirements is available, including heavy-duty types yielding 280 watts at 220 volts. A special type is manufactured with three or six plates to rectify three- or six-phase A.C. without the use of a transformer, yielding 280 or 560 watts of D.C. at 220 volts. The price of these valves compares favourably with those of other valves, and thus they have become very popular in Germany, especially for medium- and high-power work in large receivers, power-amplifiers, and radio-gramophones, where their use is a standard practice.

The conventional full-wave rectifying circuit is used for this valve. It possesses a filament heated at about 1.8 volt and taking about 2.5 amperes. The filament

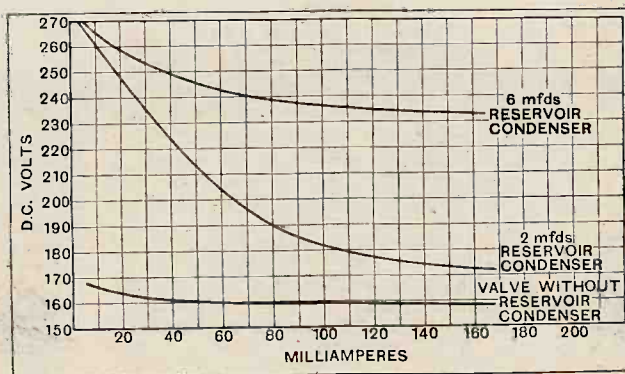

Fig. 1.—Regulation curves for different shunted capacity. With 6 mfd. there is little change in potential at the terminals of the filter when widely different loads are applied. With no capacity the regulation curve is better still.



**A New Rectifying Valve.—**

glows at a very dull red, and is extremely substantial, as its low resistance indicates, and therefore has a very long life. In fact, the life of these valves is only terminated by their vacuum reaching a degree of "hardness" at which the glow-discharge can no longer be effected and maintained in the usual way. The glow of the filament has the effect of evaporating the mercury, which is present for the greater part in liquid form when the valve is cold, due to the comparatively low vacuum and high gas pressure in the valve. The mercury then evaporated reduces the internal resistance and assists the glow-discharge taking place.

It would, therefore, seem advantageous to apply A.C. potential to the plates and heat the filament for several seconds before applying the load to the rectified potential, and this is borne out in practice. The life of the valves is considerably prolonged if this precaution be taken, especially if the load is near the maximum capacity of the valve. The average life of the valve under such conditions is in excess of a thousand hours, which

is a very good figure for a gas-filled valve of this design. Momentary peaks of load up to three to four times the normal maximum, such as would be brought about by accidental short-circuits, etc., can be sustained without "backlashing," which is the inevitable result of continuous overloading and applying maximum loads without first heating up the filament, especially in a valve of such low internal resistance working at potentials of several hundred volts.

Fig. 1 shows a series of curves taken of the D.C. output potential in relation to the load for different reservoir condensers. Especially the curve taken of the valve alone without any reservoir condenser shows scarcely any potential drop whatever with the rising load, the result of the extremely low internal resistance.

The development of this valve, largely due to Dr. Spanner, has been of the greatest importance for the mains-operation of sets in a simple and economic way, and has supplied mains-operated apparatus with a source of H.T. of such "elasticity" as to compare quite favourably even with an H.T. accumulator.

**I**N designing this instrument the makers kept in mind two salient points: (1) the attainment of a high standard of quality in the reproduction of both radio and gramophone records, (2) the maintain-

**THE CLARITH  
RADIO-GRAMOPHONE.**

ance of engineering standards of robustness and reliability in manufacture and testing.

The accompanying photograph of the interior of the set shows that there is no suggestion of the delicate scientific toy about the amplifying equipment. The layout and massive quality of the components are reminiscent rather of transmitting practice.

The amplifier, which is common to both radio and gramophone pick-up circuits, is assembled on the base platform, which is metal covered. There are two transformer-coupled stages, the output valve being an AC/P1 capable of an undistorted output of 1,000 milliwatts, which is sufficient to drive the moving coil loud speaker at full volume.

Indirectly heated valves are used in both the A.C. and D.C. models. In the A.C. model illustrated H.T. is derived through a Mazda S.P.42/U (U60/250) full-wave rectifier, while the loud speaker field is energised from a Philips P.506 full-wave rectifier.

The moving coil loud speaker is also mounted on the base platform in a position coinciding with the aperture in the cabinet. The diaphragm is of the corrugated type which automatically adjusts its effective diameter to the frequency applied.

The radio unit and control panel, which is wired as a separate unit, is mounted immediately above the loud speaker, and is linked to the amplifier through cleated leads running down the side supports. A leaky grid detector in conjunction with a dual range reacting tuner unit provides local station reception with the possibility of alternative programmes. An external aerial varying in length accord-

ing to circumstances is necessary. The volume control takes the form of a Centralab which controls both radio and gramophone volume.

We have had an opportunity of testing one of the receivers and found the reproduction full and round with excellent volume. A noticeable feature of the reproduction from gramophone records is the entire absence of surface scratch.



General view of the Clarith radio-gramophone, showing simplified control panel and moving coil loud speaker grille.

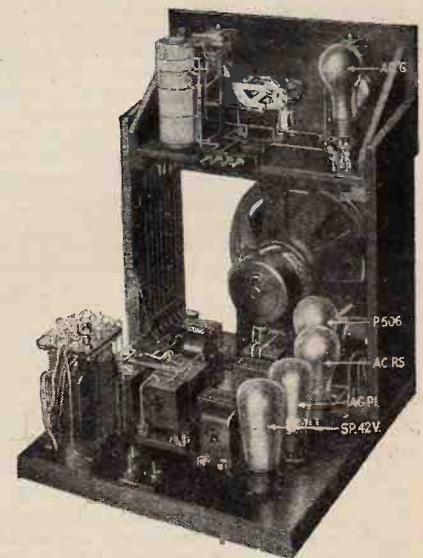

Amplifier-receiver unit for A.C. mains. The receiver unit and control panel are mounted above the loud speaker, while the power amplifier and rectifier units occupy the base platform.

A rigorous system of testing has been evolved for each component and for the various stages of assembly, and taking into account the rugged appearance of the finished product it is safe to predict that this reproducer is destined to set new standards in reliability and long service.

The makers are Messrs. Clarith Reproducers, Ltd., East Street Mills, Leeds.

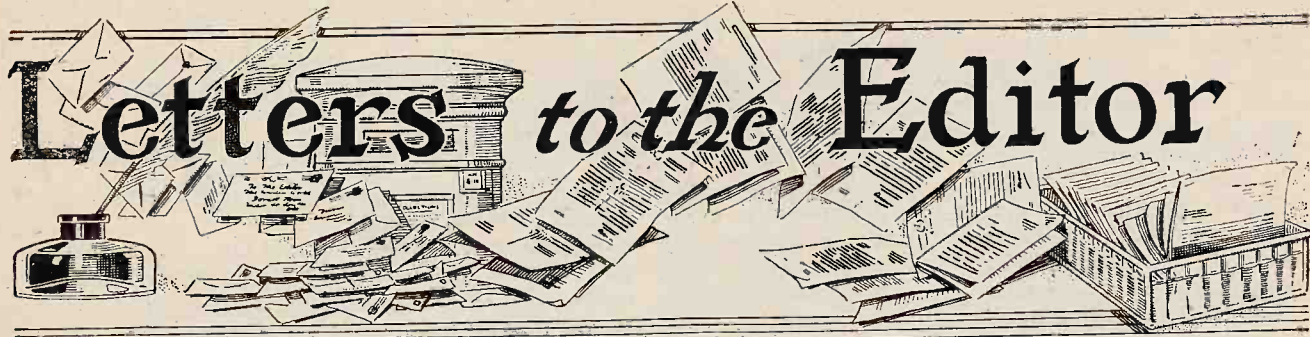

# Letters to the Editor

The Editor does not hold himself responsible for the opinions of his correspondents.

Correspondence should be addressed to the Editor, "The Wireless World," Dorset House, Tudor Street, E.C.4, and must be accompanied by the writer's name and address.

## EMPIRE BROADCASTING.

Sir,—The many letters published in your paper convince me that G5SW is a washout east of Suez. One correspondent thinks we are rather rubbing it in when we say that nearly everything but British is on the SW. In vain do I tune in to 25.53, and for days, and even weeks, I could not get the carrier till last week at 7 p.m., I.S.T. (1.30 p.m., G.M.T.) I heard the announcer say, "G5SW at Chelmsford, England, closing down till 7 p.m. G.M.T." Also that G5SW *sometimes* worked on 11.55 metres—that is, if I heard correctly the wavelength, and note, please, the "sometimes." Why not send the wireless Press a short paragraph giving times and days? Why so casual? Within a few minutes of this (of G5SW on R2 or 3 strength) Stockholm came roaring in up to 9.30 p.m.

These are the hours we want, i.e., between 2 to 7 p.m. G.M.T., and if Holland, Germany, Manila, and now Sweden can do it, what is wrong with G5SW? I have before mentioned there are 50,000 British lads in the Army out East who would be glad to get some home-news, etc. Most of the present Army had their crystal sets in England, and by clubbing together could get a 3-valver to while away the often too long evenings between sunset and bedtime. Is the British manufacturer unconcerned, and is he going to allow the opportunity to slip by? If Britain is on the "air," then people will buy British sets to hear her. Geographically, Huizen, Hilversum, Leesen, and Stockholm are not so situated as to make things different for G5SW, and so far as Irak, India, and the F.M. States are concerned, G5SW is included in the fanwise direction, and "what one fool can do, etc."

India.

RADIOX.

December 11th, 1929.

## THE PROGRAMME DIFFICULTY.

Sir,—Referring to the article with the above title in your issue of December 25th, you were good enough some time ago to publish a letter from me in which I suggested a scheme of broadcasting on lines similar to that put forward by your contributor. I mention this particularly because in the article referred to your contributor states, "It is somewhat remarkable that the means by which these alternatives can be provided have not previously been suggested."

The scheme I suggested called for a large number of stations of low power, each relaying simultaneously a number of programmes produced at a central controlling station, wavelengths being employed to distinguish the separate programmes only, and not the individual stations as at present. The relay stations would be fed either by land line or wireless.

The chief objection to the scheme, apart from expense, would appear to be the difficulty of providing land lines capable of transmitting the programmes without appreciable distortion. There is also the question as to the practicability of radiating on four (or more) wavelengths from the same site without mutual interference, especially as the frequency separation might in certain cases have to be quite small.

Bristol.

G. B. BENNETT.

Sir,—Major MacCallum's suggested synchronised transmission scheme is either five years too late or at least five years too soon. In the old days of bad receivers and horn speakers it mattered little that land lines added adenoids to artistes. But wireless can no longer amuse by its novelty. The possibilities of reception have reached a very high standard, far higher than that of present land-line transmission. S.B. is no longer tolerable. Possibly in the uncertain future, when line transmission has been enormously increased in quality, it may become acceptable. For the present, however, any extension of the use of land lines is a step in the wrong direction. Admittedly the Regional Scheme is not ideal, but it is the best solution of the problem yet advanced.

Bexley Heath.

A. G. WARREN.

## "KILOHMS."

Sir,—May I suggest that much time, ink, paper and breath would be saved by the introduction of a term for thousands of ohms? I have had this in mind for some time, and the need is emphasised by a perusal of the "Valve Data Supplement" (*The Wireless World*, December 4th, 1929) with its armies of noughts in the A.C. resistance column.

The obvious suggestion for such a term is "kilohms." Your assistance in securing the general adoption of this would, I have no doubt, be greatly appreciated.

E. H. LAISTER.

Hon. Sec., North Middlesex Radio Society.

## THE SELECTIVITY-QUALITY PROBLEM.

Sir,—I expected to see in *The Wireless World* at least one letter commenting on Mr. Bertram Hoyle's article in the November 27th issue, for there must be several of your readers who were not deceived by his explanation of the greater selectivity obtained as he describes. The following extract from a paper on the detector read before the Cambridge University Wireless Society last October bears on the point.

"There is a fallacy which has appeared in different forms so much in the literature on this subject that I think it is worth pointing out here. It is said that when a rectifier is insensitive to weak signals the strong components of the input are relatively enhanced. This is not a mathematical consequence; in some cases it is true, in others it is not. This is because the rectifier does not act on each input component separately, but on their sum.

"When the rectifier has the simple 'square law' characteristic  $i = av + bv^2$  (where  $i$  = current,  $v$  = applied voltage,  $a$  and  $b$  are constants) if the input is a strong signal  $V \sin pt$  and a weak  $v \sin qt$  we have:

$$i = a(V \sin pt + v \sin qt) + b(V^2 \sin^2 pt + v^2 \sin^2 qt + 2Vv \sin pt \sin qt) = a(V \sin pt + v \sin qt) + \frac{b}{2}[V^2 + v^2 - V^2 \cos 2pt - v^2 \cos 2qt + 2Vv \cos(p-q)t - 2Vv \cos(p+q)t]$$

In this case the direct current in the output is  $\frac{b}{2}(V^2 + v^2)$ , so that the strong component  $V$  is relatively enhanced. We may

also note the term  $bVv \cos(p-q)t$ , the heterodyne beat note, which is proportional to  $v$ . If the two input signals are carrier and sideband, this is the required audiofrequency note, and is DIRECTLY PROPORTIONAL to the amplitude of the sideband. [This was forgotten in an article in *The Wireless World* in December, 1927.] The detector is, however, not ideal, as unwanted beat notes are also produced between the sidebands, resulting in distortion.

"When the rectifier has the characteristic  $i=av+bv^2$ , which is even less sensitive to small inputs, we find the direct current in the output for the same input as before is  $\frac{2}{3}b(V^2+v^2+4V^2v^2)$ . Hence if the signal  $V \sin pt$  stopped, this would fall by  $\frac{2}{3}b(V^2+4V^2v^2)$ , and if the signal  $v \sin qt$  stopped it would fall by  $\frac{2}{3}b(V^2+4V^2v^2)$ , so the ratio of the two components in the output is  $\frac{V^2+4V^2v^2}{v^2+4V^2v^2}$

"If  $V=2v$ , and  $V$  is not enhanced, this ratio should be  $\frac{V}{v}=2$ , but it is  $\frac{16+16}{1+16} < 2$ , so that the WEAK component  $v$  is relatively enhanced."

The above applies to a rectifier alone or a detector in which the load impedance is negligible. A simpler explanation is that the weak signal modulates the stronger signal at the difference frequency  $p-q$ , the input varies from  $V+v$  to  $V-v$ , hence the response is quite independent of the response to  $v$  alone.

The variation of selectivity with variation of detector grid bias is connected with the de-modulation effect described by Dr. Beatty in *Experimental Wireless* for June, 1928, and is not as simple as suggested by Mr. Hoyle. W. B. LEWIS.

Beckenham, Kent.

Sir,—I was interested to read Mr. Lewis's letter commenting on my recent article, "The Selectivity-Quality Problem."

The article he refers to was published after I had sent in mine. It shows mathematically the ratio of the two components in the output to be  $\frac{V^2+4V^2v^2}{v^2+4V^2v^2}$ , so that unless  $\frac{V}{v}$  to begin with is  $>2$  no gain is obtained; in fact the weaker signal is enhanced. Where the device works as described is with a considerable difference between  $V$  and  $v$ . With  $\frac{V}{v}=10$  the ratio given above comes out to 26, and is greater for larger values of  $\frac{V}{v}$ .

Since it was only on stations having a large difference of initial intensity that the scheme was attempted, no cases of its failing were noted.

I am glad of this opportunity of thanking Mr. Lewis for his criticism, which gives readers this more accurate outlook on the phenomenon.

The references given in his letter should prove useful to readers wishing to follow up the mathematics of the case.

Heaton Moor, near Stockport. BERTRAM HOYLE.

RECEPTION OF CONTINENTAL STATIONS.

Sir,—I have read with awe and veneration the descriptions of various achievements in the way of reception of distant programmes which certain of your correspondents have related in letters which you have published. I am particularly intrigued by one gentleman's account of his "conveniently agreeable" reception of some twelve Continental programmes which he assures us he usually receives on a four-valve portable receiver (admittedly expensive!)

If only these wizards could be prevailed upon to come to the assistance of the B.B.C. with what delights might we not be regaled in the way of Continental relays, and no land-line distortion to spoil the excellent quality for which so many Continental broadcast stations are noted.

I remember a somewhat sweeping assertion of one "Ixion" in your sister journal, *The Motor Cycle*, which runs, "Motor cyclists, like anglers, are constitutionally untruthful."

I hardly like to be rude enough to suggest that certain wireless listeners might be included in the same category.

Salisbury. E. W. ARNOLD.

B 37

Sir,—It is possible to receive foreign transmissions without all the interference of which Mr. A. W. Scott complains. It just depends on the receiver and one's ability to use it to the best advantage. With two efficient stages of screened grid high-frequency amplification and anode bend rectification it is possible with careful control of input and output to cut out interference. My receiver is a "Kilo-mag Four," with a resistance-capacity coupled low frequency stage, and I can receive Budapest, Vienna, Prague, Milan, Rome, Bucharest, Radio-Toulouse, Barcelona and all the powerful German stations at good strength on a moving-coil speaker. I listen regularly to operas from Vienna, Milan and Rome. The long-wave stations are there, too; one has only to select a suitable programme.

I suggest that as Mr. Scott is disappointed with foreign station reception he should build a "Kilo-mag Four." I am certain that he will not be disappointed with the results.

Grimsby. J. H. BORRILL.

Sir,—It is not the set usually that causes the trouble but the locality in which it is used.

My own house is dreadful for reception, which is much upset by local static, Sunday evenings excepted. The set used is a Superhet.

I also have a set exactly similar at a relative's near where the Trent and Ouse meet to form the Humber, apparently miles from anywhere. Here the foreign stations come in with a clarity unbelievable, on a background of silence.

I also pay a weekly visit to a friend two miles outside Rotherham; he also uses a Superhet, and his reception is perfect, with just a slight trace of interference from trackless trams now and again. The quality and strength of foreign stations are quite equal to that of our own British stations. ALFRED FRANCE.

Rotherham.

Sir,—I am interested to note that Mr. W. Oliver has taken up the cudgels on behalf of the "reacher out" in your issue of December 11th. I quite understand his point of view and congratulate him upon his faculty for enjoying upwards of twenty Continental transmissions on most evenings. Happy man! How I envy him! Let him now add a second H.F. stage to his receiver and he can then enjoy twenty or thirty more.

Perhaps my expressions "absolute myth" and "awful noises" were a trifle more forcible than accurate—they should not be read too literally. Doubtless there are people who enjoy these noises—Mr. Oliver appears to be one of them. I myself, and I believe the majority of your readers, are not so easily pleased, and I entirely agree with the remarks of your correspondent, Mr. L. N. Grover, in this connection.

Of course, the main point of my letter was that it is no concern of the B.B.C. to give the slightest regard or consideration to the "reacher out."

Chipstead, Surrey. A. W. SCOTT.

Sir,—I get a great deal of enjoyment by listening to some of the foreign stations, and I will admit that some of their programmes are well worth listening to. But I think that for quality of transmission and quality of programmes the B.B.C. stations can claim first place every time.

Croydon. K. H. RANDALL.

B.B.C. TRANSMISSIONS.

Sir,—Mr. E. C. Richardson's suggestion in your issue of 4th ult., that amateurs should combine in constructive criticism by comparing notes, is very apt. I think listeners must accept the fact that variations in output from different studios and halls may be technically necessary, and that errors of judgment as to the moment of modulation may humanly occur. Secondly, we must accept the testimony of experts (not all on the B.B.C. staff) that there really are such effects (or causes) as "transients" with which even the best receiver or loud speaker may fail to cope. There may be very costly three- or four-valve sets which get over this "transient" difficulty, but they are out of the question for the majority. My own set consists of one S.G. H.F. stage, anode-bend detector without reaction, R.C. coupled to L.F. stage which again is transformer coupled to a P.625a output valve, working a Magnavox M.G. speaker through a

choke-capacity filter circuit. The detector anode circuit includes H.F. choke, H.F. by-pass condenser, and stopping resistance between coupling condenser and grid of L.F. valve. The H.T. is supplied by a mains unit, and the L.T. is kept "up to scratch" by a trickle charger. My ear is fairly sensitive, but my only complaint as to errors in reception is an overload effect with high soprano solo notes or heavy choral work, manifesting itself as a horrible "hard breathing" effect below the musical note. I cannot fairly blame the transmission on the engineering side for this effect. Again, one piano only in one of the London studios broadcasts with horrible "dithers" almost through its entire compass. On the same evening, without any adjustments to my set, other pianos either from Savoy Hill, or outside, have broadcast with perfectly pleasing results.

Now, to what conclusions do these details point? I suggest that the trouble is not so much in the engineering output or modulation, but in the input from the instrument or vocalist.

To my mind, most of these transmission troubles are due to the old telephone speaking fallacy, translated into various forms, i.e., that to make one's self heard clearly it is necessary to shout into the mouthpiece. Most habitual telephone users know with sorrow that the effect is precisely the reverse.

I am not a great lover of dance music, but honour should be given where due—Jack Payne seems to have discovered the art of "positioning" his players to a nicety; the result is a perfect balance of tone. And his voice is always clear. Other more ambitious players and singers, please copy.

W. C. BURBRIDGE.

Sir,—I trust your readers have not been misled by that deceiver of the young, Mr. Munn, and his vivid similies.

The human ear may be compared in some respects with the loud speaker, but the senses have little in common with a thermionic valve amplifier.

In addition to varying sensitivity at different frequencies, the amplifier rectifies above a maximum amplitude, the actual maximum varying with the frequency and with the characteristic of the amplifier. Hence the great piano controversy, which I had hoped was long since dead.

A comparison between 5GB and 2LO is very misleading; with most receivers the side-band cut-off is more pronounced in the case of 5GB owing to its higher wavelength. Its modulation is also deeper, and, in my experience, it requires a diode detector.

I am using a modification of the receiver described by Mr. Kirk in *The Wireless World* about a year ago; I work on up to 1 milliamp. rectified current, the L.F. amplifier being a 6,000 ohm valve resistance coupled (20 ohms, -25 mfd., 100,000 ohms) to two P.625s in parallel, 230 volts H.T., and choke filter output.

It may interest Mr. Richardson to know that I never experience lipping or blasting on the ordinary transmissions from 2LO, 5GB, or 5XX, although occasional "O.B.s" or long-distance land-line transmissions (e.g., Liverpool, Plymouth) through London are sometimes distorted.

The speaker I use is a moving coil built to Dr. McLachlan's specification, but I have obtained satisfactory high-note reproduction from a 12in. reed-driven cone employing Brown, Blue-Spot or Lissen (old type) units.

Finally, I tested, and found quite satisfactory, a linen-diaphragm speaker, which gave very poor results on a neighbour's conventional set; incidentally, he had found 2LO far superior to 5GB, but on making alterations in detector bias, anode resistance and shunt capacity the position was reversed!

Wherefore I am in full agreement with "Fair Play," and say: Look to your set, especially the detector valve and associated circuits.

G. G. HANKEY.

Maidenhead.

Sir,—

No, Mr. "Fair Play," of Yalk, Yalks, I'm afraid you are wrong, by long chalks.

It's long land-lines which mangle

Transmissions and tangle

Up Hamilton Hartly and Talks.

Woking.

G. M. PART.

Sir,—The differences in land-line qualities noted by your correspondent, Mr. E. C. Richardson, obviously point to that much-maligned B.B.C. department, the Control Room, and as the B.B.C., in their own interest, and not being bigger fools than their critics, must have done their level best to maintain the highest possible equality of control throughout their long transmissions (most days 10.15 a.m. till midnight), no fair-minded person can believe that this department has yet succeeded in perfecting this matter, although it must be generally admitted that its transmissions taken as a whole are the best in Europe. Incidentally, I have yet to read any constructive criticisms in this connection.

HERBERT S. COPPOCK.

Didsbury, Manchester.

Sir,—Mr. Bertram Munn, who writes in your issue of December 4th, has missed his vocation in life; he should have been a comic writer (he may be!), but, having finished with the comic stuff, I take it that he thinks outside broadcasts rotten. I am afraid that I and a great many other people up here think that transmissions from Queen's Hall, People's Palace, and various other public places absolutely eclipse the studio quality, which is stuffed up and unnatural.

Arnside, Westmorland.

WILFRID SHARPE.

Sir,—I have spent a considerable amount of unnecessary time "looking to my set," when the fault has proved to be the "other end."

Some weeks ago the quality of the service relayed from Bournemouth was so bad that I dismantled the M.C. speaker, as the coil is wound with a copper strip, and I had decided that this was causing the chatter. To my great annoyance, on substituting a spare coil, I found the trouble persisted, only to become perfect on reverting to London for the "news."

Crawley, Sussex.

ERIC J. PEARCE.

Sir,—There is one point which has so far not been clearly brought out, viz., the general poor level of the quality of transmissions from 5XX Daventry. The higher and lower frequencies seem both sadly lacking, and improving the L.F. amplifier, increasing the H.T. voltage, and improving loud speaker response on the receiving side only seem to bring this fact into greater prominence.

It is, however, a matter of common experience that programmes performed in London and transmitted from 5GB can be, and usually are, of excellent quality, with a brilliant upper register and thumping bass. And yet, presumably, the same length of land line exists in each case.

A. M. ROACH.

Kingston Hill.

Sir,—With reference to your correspondence regarding land-line transmissions, it may interest your readers to hear that from here (Geneva) the difference in quality and volume between direct and relayed broadcasts from British stations is always noticeable, and often most marked.

At a distance of roughly 500 miles one has, of course, to be content with comparatively imperfect reception, and the good old days of five years ago, when one could pick up all the main British stations (even relays), are past, and the only British station now left unswamped by the Germans is 5GB. Nevertheless, there is always a sharp difference between the woolly obscurity of the first news bulletin, for instance (relayed from 2LO), and the second (broadcast from the Birmingham studio); and the light music following the first bulletin seems suddenly to jump out of the loud speaker after one has been straining one's ears and nerves to hear how Lindrum and Smith are progressing.

Moreover, it is sheer nonsense to say that imperfect reception is invariably the fault of the receiving set. One has only to turn the dial over from a British station at its best or from the German stations (which also give excellent quality, though rather hard tone) to stations like Lyons, Toulouse, or Seville, which seem to suffer from perpetual sore throat, due to rank bad modulation. After all, if one can get good and bad quality signals on the same set within a few minutes of each other, the fault for the bad signals obviously lies at the transmitting end.

G. D. MILLAR.

Geneva, Switzerland.

READERS

PROBLEMS

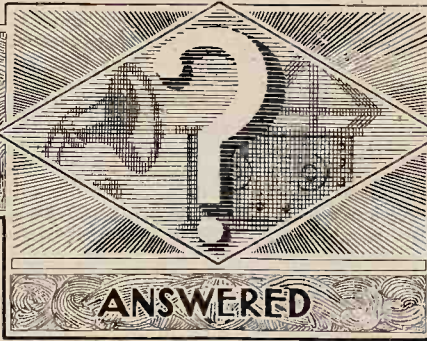

The Service is subject to the rules of the Department, which are printed below; these must be strictly enforced in the interest of readers themselves.

A selection of queries of general interest is dealt with below, in some cases at greater length than would be possible in a letter.

"The Wireless World" Supplies a Free Service of Technical Information.

H.F. Transformer Primaries.

I am using "The Wireless World" Kit Set coils in constructing a four-valve A.C. mains receiver having a single H.F. stage with a Mazda A.C./S.G. valve. Will you please tell me how many turns should be added to the primary windings of the H.F. transformer?  
D. G. B.

In order to attain maximum amplification a considerable increase should be made in the number of primary turns, but actually the windings specified make a good compromise between the requirements of range and selectivity, even though the valve in question has a considerably higher impedance than that for which they were originally designed.

We recommend that you should try the H.F. transformer as it stands, and then, if selectivity and stability are both in excess—the latter quality will, of course, depend to some extent on circuit details and screening—add another primary section to both long and medium wave transformers.

o o o o

Modernising an Eliminator.

I have a rather out-of-date eliminator giving a main output rated at 120 volts 25 milliamps, and another terminal intended for feeding a detector valve, which is supposed to give up to 100 volts, variable in five steps by a rotary switch. It was thought that this latter output would be suitable for supplying the screening grid of my "S.G. Regional" receiver, but a test shows that this is not so. As a temporary measure I am feeding the three anode circuits from the main output terminal, and have connected a battery of small dry cells for the screening grid. These cells now show signs of decline, and, if possible, I should like to devise a more satisfactory and permanent arrangement. Can you help me?

I should perhaps make it clear that, as far as results go, the present eliminator leaves nothing to be desired; it is mainly to avoid renewing the cells that a change is desired.

M. M. R.

We advise you to try the arrangement suggested diagrammatically in Fig. 1; this requires the addition of a wire-wound

potentiometer of between 30,000 and 50,000 ohms, which is connected externally between eliminator and set in the manner shown.

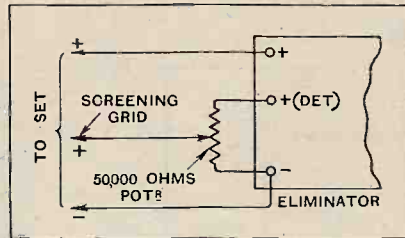

Fig. 1.—Critical adjustment of eliminator output voltage is obtained by adding an external high-resistance potentiometer.

In the absence of full details as to the method adopted for "breaking down" the voltage supplied from the "detector" terminal of your eliminator, we cannot say definitely that this connection will afford the desired voltage for the screening grid. In all probability all will be well, but if any trouble is experienced the external potentiometer must be joined between the negative and main positive terminals of the eliminator.

RULES.

- (1.) Only one question (which must deal with a single specific point) can be answered. Letters must be concisely worded and headed "Information Department."
- (2.) Queries must be written on one side of the paper, and diagrams drawn on a separate sheet. A self-addressed stamped envelope must be enclosed for postal reply.
- (3.) Designs or circuit diagrams for complete receivers cannot be given; under present-day conditions justice cannot be done to questions of this kind in the course of a letter.
- (4.) Practical wiring plans cannot be supplied or considered.
- (5.) Designs for components such as L.F. chokes, power transformers, etc., cannot be supplied.
- (6.) Queries arising from the construction or operation of receivers must be confined to constructional sets described in "The Wireless World" or to standard manufacturers' receivers.

Readers desiring information on matters beyond the scope of the Information Department are invited to submit suggestions regarding subjects to be treated in future articles or paragraphs.

Long Wave Troubles.

My "2 H.F. set," built in accordance with suggestions made in recent articles is working exceptionally well on the medium broadcast waveband, but is totally lacking in stability on the long waves. This puzzles me, as I have always thought that the small residual capacity of a screen-grid valve has little effect at comparatively low radio frequencies, and that, having achieved stability with regard to high frequencies, the rest should automatically follow.  
J. W. W.

It is correct to assume that there should be less tendency towards H.F. instability on the long waveband in an amplifier such as you describe. When a set of this kind fails to operate satisfactorily on this band, although it puts up a good performance on medium waves, the first thing to suspect is imperfect separation of H.F. and L.F. components in the anode circuit of the detector valve; failure in this respect often gives rise to an effect not quite the same as ordinary self-oscillation due to interaction, but very similar to it.

To assure yourself if this is at the root of the trouble it is a good plan temporarily to connect a much larger condenser—say 0.002 mfd., or even more—than can be generally tolerated from the "L.F." point of view between detector anode and earth. If this provides a cure for instability, it can safely be assumed that the normal filtering devices are inadequate.

It should be added that trouble of this kind is sometimes traced to the use of decoupling condensers of excessively low value.

o o o o

Parallel-fed L.F. Amplification.

Will you please tell me if the parallel feed method of L.F. amplification is applicable only with modern inter-valve transformers having high-permeability cores, or whether it can be used with ordinary transformers.

V. H. R.

Generally speaking, this system confers greater advantages when dealing with the modern "Mu-metal" transformers, but it is a mistake to assume that it cannot be successfully applied to the larger transformers with ordinary cores.

**Unsuspected Current Leakage.**

Will you please examine my circuit diagram (on which resistance values and details of valve types, etc., are marked), and say whether I am correct in assuming that the total anode current consumed will amount to about 25 milliamps with a common input of 150 volts. My problem is to know whether it is safe to take this figure in calculating the value of resistance necessary to absorb the surplus voltage delivered by my eliminator. J. B. V.

With regard to the valve anodes, your estimate as to total current consumed is as correct as need be, but you have ignored the fact that the screening grid potentiometer will also impose a load on the eliminator. This potentiometer is, according to your diagram, composed of

wavelength adjustments, and it might possibly be found that your aim to achieve a simple switch changeover would be defeated by the fact that the reaction adjustment for one wavelength might not hold good for the other. However, as you are situated at less than 20 miles from Brookmans Park, we do not think that this objection will hold in your case, as it should be quite unnecessary to tighten the reaction coupling to anything approaching the oscillation point for either wavelength. It should be easy to find an adjustment which holds good for both stations.

We have shown a fixed condenser in series with the aerial; you might find it convenient to make this either variable or semi-variable in order that it may be used as a rough-and-ready form of volume control.

trame limit of their range where a good deal of reaction is necessary.

**Increasing Wavelength Range.**

I find that my det.-L.F. set will not tune down to the new Regional station working on 261 metres; a reduction in aerial length does not have any appreciable effect in extending the lower limit of its wavelength range. Should this be so? Will you please suggest a way of altering the set so that the alternative transmissions may be received. E. C.

From the fact that alterations in aerial length (and consequently in aerial capacity) do not have any appreciable effect in changing the tuning range of the grid circuit, it is fair to assume that your set includes either an "aperiodic" aerial-grid transformer, or that the aerial is coupled to the grid through a very small fixed condenser. In either case the remedy is the same; you must make a reduction in the inductance of the tuned circuit, and if provision is not made for using interchangeable coils the only way of doing this is to remove a few turns from the winding. We suggest that you should take off a few turns at a time until the desired wavelengths are received.

**A Composite Receiver.**

Can you see any disadvantage in combining the high-frequency amplifier of the original Everyman Four with the detector and L.F. amplifier of the new (1930) set? The aerial tuning arrangement of the latter receiver would be embodied, and interchangeable coils would be used for the two wavebands. D. W. B.

Up to a point, this circuit arrangement should be highly satisfactory, but it must not be expected that it will provide as much H.F. amplification as that afforded by the "1930" Everyman Four" with the best type of modern screen-grid H.F. valve. Selectivity will be of a very high order if proper use is made of the aerial coupling adjustment.

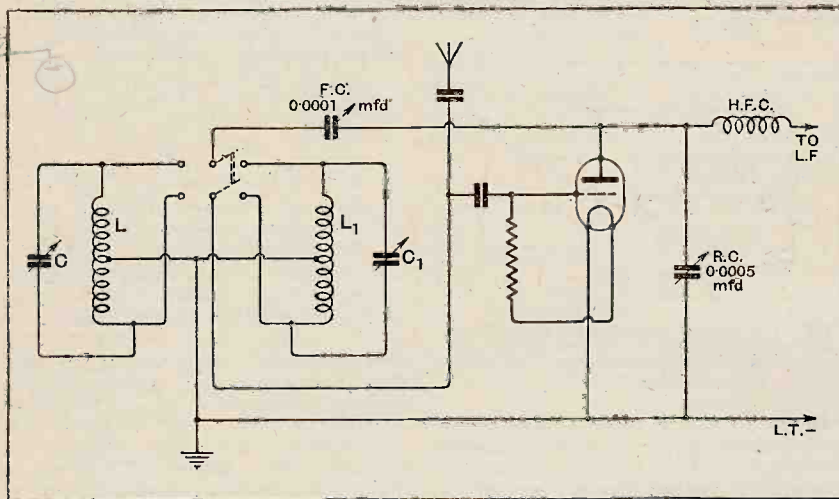

Fig. 2.—A regenerative detector circuit arranged for easy switching-over to alternative transmissions. Standard components may be used.

a fixed and variable limb, with values, respectively, of 10,000 and 20,000 ohms. This gives a total of 30,000 ohms, which will pass 5 milliamps when 150 volts are applied. This extra current must be added to that consumed by the anode circuits, so you should allow for a total of 30 milliamps.

o o o o

**Alternative Programme Reception.**

Will you please give me a circuit diagram of a throttle-controlled reacting detector valve arranged for alternative programme reception? I should like so to arrange matters that it is possible to change programmes by switching over from one tuned circuit to the other. I am, of course, prepared to use separate pairs of tuning coils and condensers. T. S. S.

We think that the circuit shown in Fig. 2 should be entirely suitable for your purpose. In this diagram the two separate tuning circuits are represented by L, C and L<sub>1</sub>, C<sub>1</sub>.

It will be observed that the reaction control condenser R.C. and the reaction feed condenser F.C. are common to both

**Frame Aerials and Quality.**

The majority of frame aerial sets to which I have listened seem to be deficient in the matter of quality, or at any rate they do not give such good reception as receivers with outside aerials. Do you consider that this is inherent in the design of a self-contained set? S. D. H.

There is no basic reason why a frame aerial set should not give quite as good results as one with an outside aerial, although it is admitted that risk of trouble is somewhat increased in the case of the self-contained receiver. In the first place, there is generally greater tendency towards H.F. instability, and some sets are found to be on the verge of self-oscillation over a considerable part of the tuning scale; this incidental reaction will naturally impair quality. Again, many sets must of necessity be fitted with small-capacity H.T. batteries in view of the space available, and this in turn leads to the use of an output valve with strictly limited power-handling capacities.

Further, it is possible that you may have formed your opinion after listening to frame aerial sets working at the ex-

**FOREIGN BROADCAST GUIDE.****TUNIS-KASBAH**  
(North Africa).

Approximate Geographical Position: 36.48° N. 10.18° E.

Approximate air line from London: 1,360 miles.

Wavelength 1,350 m. Frequency 222.2 kc. Power 0.6 kW.

Time: Central European (one hour in advance of G.M.T.).

Transmits daily from 8.15 p.m. G.M.T. Male Announcer. Call: *Allo! Allo! Ici le Poste Radiotéléphonique de Tunis-Kasbah.* Announcements are made in French and Arabic.

Under the heading "Foreign Broadcast Guide," we are arranging to publish a series of panels in this form, giving details regarding foreign broadcast transmissions.

# MISCHA LEVITSKI

## hears 'the impossible'!

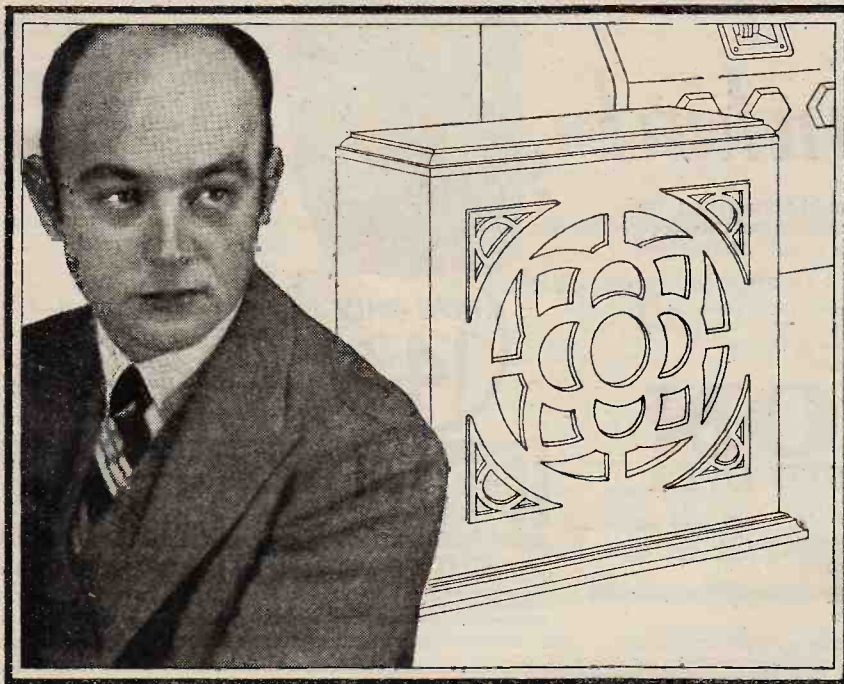

*"I have heard what I thought impossible," says Mischa Levitski, the brilliant pianist—"the true authentic notes of a piano coming from a radio loud speaker. The radio was a Marconiphone, and so was the speaker."*

Choose your programme—orchestra, dance music, a speech. On a Marconiphone loud speaker it will come through clear-cut, flawless. Sir Edward Elgar, Theodor Chaliapine, Albert Coates, many other famous musicians, have found in the Marconiphone tone and volume unrivalled today.

Marconiphone engineers make these speakers. All the skill of thirty years' leadership in wireless is in their construction. Ask any dealer for a demonstration. If there is no dealer near you, write to the Marconiphone Company Limited, 210-212 Tottenham Court Road, London, W.1.

Listen with a

# MARCONIPHONE LOUD SPEAKER.

THE FIRST AND GREATEST  
NAME IN WIRELESS



MODEL 60 CABINET CONE  
*(shown on left)*

Obtainable at the very moderate price of £3, the Model 60 is an extremely efficient "all-purpose" speaker. Embodying the Marconiphone reed system, it is outstandingly clear in tone.

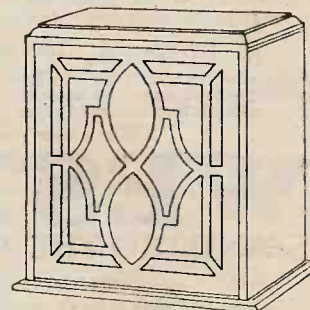

THE FAMOUS  
MOVING COIL SPEAKER

The highly accurate centring of the Moving Coil and the one-piece fibrous diaphragm ensure absolutely accurate reproduction. Units from £4.10.0. Cabinet models: for 6-volt accumulator, £7; for D.C. mains, £7.10.0; for A.C. mains, £12.12.0.

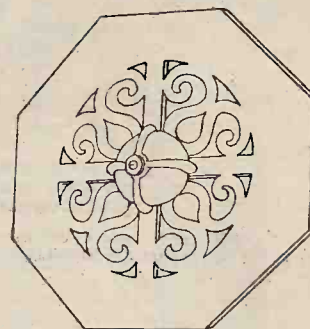

ONLY 30/-!

The Octagon Cone gives excellent reproduction equally from a 2- or a 5-valve receiver. Made in two different and pleasing designs, it can be placed on the table or hung from the wall.

# Weston sets the world's standard

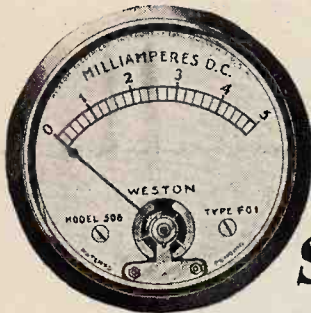

Our Model 506 MIL-AMMETER Panel Mounting type should be placed in the High Tension Circuit of the valve to ensure correct operation and to check distortion.

Prices £1 : 15 : 0—£2 : 15 : 0

Write now for your copy of "Radio Control," the Weston FREE Booklet that explains the necessity for accurate electrical control of your Radio Receiver, and gives much helpful advice.

Address your postcard to:—

## WESTON

STANDARD THE WORLD OVER  
Pioneers since 1888,

WESTON ELECTRICAL INSTRUMENT CO., LTD.,  
15, Great Saffron Hill, London, E.C.1.

A3

## IT'S SO MUCH EASIER

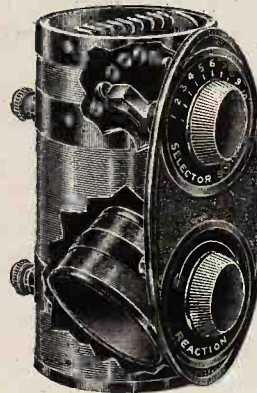

—to tune-in with a British General Aerial Tuning Unit. There is no fussing with plug-in coils. Tuning is on one dial and covers all wavelengths between 220 and 2,000 metres. Easy two-hole fixing and connections are simple and clearly defined.

And this new model is not only better but cheaper.

From all dealers of repute or direct from the manufacturers.

NOW ONLY  
**14/6**

## BRITISH GENERAL

MANUFACTURING COMPANY LTD.,  
BROCKLEY WORKS - LONDON, S.E.4.

# ENGINEERS!



### Can't we get together?

All we ask is the chance to prove that you can earn £300, £400, £500 per year or more. Other men are doing it, and you can do the same.

We have an unrivalled and world-wide organisation, waiting to help you whether you be novice or expert. If you wish for something more than a "bread and butter" job you owe it to yourself to investigate our Service.

Our handbook "Engineering Opportunities" has pointed the way to better things to over 20,000 of your fellows. It contains details of A.M.I.Mech.E., A.M.I.E.E., A.M.I.C.E., A.M.I.A.E., A.M.I.Struct.E., London Metric, C. & G., G.P.O., etc., Exams., outlines home study courses in all branches of Electrical, Mechanical, Motor and Wireless Engineering, and explains our unique guarantee of



Write for this Book today IT'S FREE!

**NO PASS—NO FEE.**

In a Brilliant Foreword Prof. A. M. Low shows clearly the chances you are missing.

"Engineering Opportunities" and our advice are quite FREE. Don't neglect this offer—give vent to that "upward urge" and send a postcard NOW, stating Branch, Post or Exam. which interests you.

BRITISH INSTITUTE OF ENGINEERING TECHNOLOGY,  
387, SHAKESPEARE HOUSE, 29-31, OXFORD STREET, W.1.

An entirely new M-L production for the ALL ELECTRIC RECEIVER, the D.C. to A.C. Converter.

40 WATT Model      85 WATT Model  
£13-0-0              £19-0-0

Power Supply Units our Speciality.

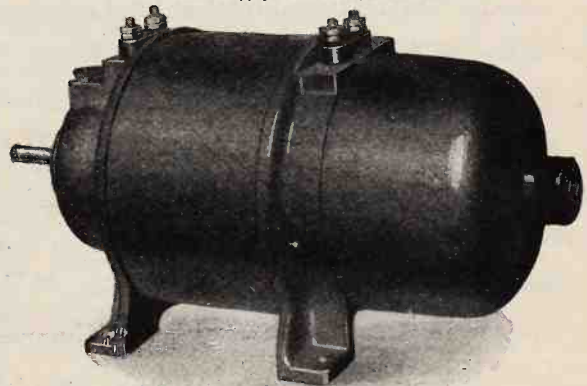

IF YOU ARE ON D.C. MAINS employ the above machine for running your ALL ELECTRIC RECEIVER. The only safe way to operate receivers from D.C. Mains. Suitable for well-known makes of Receivers

M-L MAGNETO SYND. Ltd.,  
Radio Dept., COVENTRY.

Telephone: 5001.

Mention of "The Wireless World," when writing to advertisers, will ensure prompt attention.

B42



# MISCELLANEOUS ADVERTISEMENTS.

## NOTICES.

**THE CHARGE FOR ADVERTISEMENTS** in these columns is :  
12 words or less, 2/- and 2d. for every additional word.

Each paragraph is charged separately and name and address must be counted.

**SERIES DISCOUNTS** are allowed to Trade Advertisers as follows on orders for consecutive insertions, provided a contract is placed in advance, and in the absence of fresh instructions the entire "copy" is repeated from the previous issue : 13 consecutive insertions 5% ; 28 consecutive, 10% ; 52 consecutive, 15%.

**ADVERTISEMENTS** for these columns are accepted up to **FIRST POST on THURSDAY MORNING** (previous to date of issue) at the Head Offices of "The Wireless World," Dorset House, Tudor Street, London, E.C.4, or on **WEDNESDAY MORNING** at the Branch Offices 19, Hertford Street, Coventry ; Guildhall Buildings, Navigation Street, Birmingham ; 260, Deansgate, Manchester ; 101, St. Vincent Street, Glasgow, C.2.

Advertisements that arrive too late for a particular issue will automatically be inserted in the following issue unless accompanied by instructions to the contrary. All advertisements in this section must be strictly prepaid.

The proprietors retain the right to refuse or withdraw advertisements at their discretion.

Postal Orders and Cheques sent in payment for advertisements should be made payable to **ILIFFE & SONS Ltd., and crossed & Co.** Notes being untraceable if lost in transit should not be sent as remittances.

All letters relating to advertisements should quote the number which is printed at the end of each advertisement, and the date of the issue in which it appeared.

The proprietors are not responsible for clerical or printers' errors, although every care is taken to avoid mistakes.

### NUMBERED ADDRESSES.

For the convenience of private advertisers, letters may be addressed to numbers at "The Wireless World" Office. When this is desired, the sum of 6d. to defray the cost of registration and to cover postage on replies must be added to the advertisement charge, which must include the words Box 000, c/o "The Wireless World." Only the number will appear in the advertisement. All replies should be addressed No. 000, c/o "The Wireless World," Dorset House, Tudor Street, London, E.C.4. *Readers who reply to Box No. advertisements are warned against sending remittance through the post except in registered envelopes ; in all such cases the use of the Deposit System is recommended, and the envelope should be clearly marked "Deposit Department."*

### DEPOSIT SYSTEM.

Readers who hesitate to send money to unknown persons may deal in perfect safety by availing themselves of our Deposit System. If the money be deposited with "The Wireless World," both parties are advised of its receipt.

The time allowed for decision is three days, counting from receipt of goods, after which period, if buyer decides not to retain goods, they must be returned to sender. If a sale is effected, buyer instructs us to remit amount to seller, but if not, seller instructs us to return amount to depositor. Carriage is paid by the buyer, but in the event of no sale, and subject to there being no different arrangement between buyer and seller, each pays carriage one way. The seller takes the risk of loss or damage in transit, for which we take no responsibility. For all transactions up to £10, a deposit fee of 1/- is charged ; on transactions over £10 and under £50, the fee is 2/6 ; over £50, 5/-. All deposit matters are dealt with at Dorset House, Tudor Street, London, E.C.4, and cheques and money orders should be made payable to Iliffe & Sons Limited.

### THE SALE OF HOME-CONSTRUCTED UNLICENSED APPARATUS.

#### A Service to our Readers.

We have made an arrangement with the Patentees whereby readers who wish to dispose of a home-constructed receiver not licensed under the patents made use of, can license the set by means of the Deposit System referred to above.

The person desiring to sell, in sending us particulars for his advertisement, will in every case make use of a Box No., and should add to the price which he requires the amount of royalty customarily paid by manufacturers.

If the purchaser is satisfied with his purchase, the sum realised will be forwarded to the seller, less the amount due in respect of royalties, which amount will be paid by "The Wireless World" to the owners of the patents concerned, and a certificate will be handed on to the purchaser of the set.

**SPECIAL NOTE.**—Readers who reply to advertisements and receive no answer to their enquiries are requested to regard the silence as an indication that the goods advertised have already been disposed of. Advertisers often receive so many enquiries that it is quite impossible to reply to each one by post.



## ALL WIRELESS WORLD COILS

1930 EVERYMAN FOUR	47/3 set
KIT SET, Coils with Switches	45/- set
NEW KILOMAG.	45/- set
RECORD III	45/- set
FOREIGN LISTENERS 4 B.B.C.	30/- set
METAL CABINETS	5X 37/6 set
5 1/2" DRUM DIALS with Escutcheons	38/3 to 46/6
WAVETRAP, Litz Wire	5/6
	10/6 eac

## B&J Wireless Co.

2, 3, & 4, Athelstane Mews,  
Stroud Green Road, N.4.

Arclway 1695

"END OF YEAR CLEARING."

## APPLEBY'S

FOR BARGAINS WATCH Phone : Paddington 8928 (3 lines)  
THE MISCELLANEOUS COLUMNS THIS MONTH.

For Modern High-grade Material Only.

CHAPEL ST., LONDON, N.W.1

OPEN TILL 7 P.M. SAT. 1 P.M.

# KUSHA PICK-UP ARM

Showing a new swivel "Continental" fitting which allows turn of pick-up for easy insertion of needle from the top whilst maintaining the advantage of the long drop section.



LENGTH 10 1/2 ins.  
HEIGHT 3 1/2 ins.

## 12'6

Also H.M.V. Fitting.  
STANDARDISED BY G.E.C.

Vibrationless. Weight-relieving (adjustable). Adaptable in angle and length to ensure true tracking under all conditions.

Of G.E.C., all best Factors and Dealers, or

R. H. GLASSCOE & CO.,

71, MOORGATE, LONDON, E.C.2.

MUCH IMITATED

## CLAROSTAT

NEVER EQUALLED

REDUCED PRICES!

STANDARD. WAS 10/6 NOW 9/6

VOLUME. " 8/6 " 7/6

POWER TYPES. WERE 15/- " 13/6

FREE

40 Page Illustrated Booklet with Scale Drawings all types mains apparatus etc.

CLAUDE LYONS LTD.

76, OLDHALL ST., LIVERPOOL.

## RECEIVERS FOR SALE.

**SCOTT SESSIONS and Co.**, Great Britain's Radio Doctors.—Read advertisement under Miscellaneous.

**3-VALVE All-wave Receiver**, latest type, powerful, perfect; £4.—V. Taylor, 57, Studley Rd., Stockwell, London. [0274]

**RECEIVERS for Sale**—Portable 5-valve, suit case type, complete, as new, perfect; £9/17/6.—N. Taylor, 57, Studley Rd., Stockwell, London. [0323]

**G.E.C. 7-valve Supersonic Portable Receiver**, complete with valves, L.T. battery, and H.T. unit (A.C.), as new; reasonable offer accepted.—T. Bridger and Son, High St., Slough. [7710]

**MARCONIPHONE Type 35 Screened Grid 3-valve Sets**, brand new; £9, with valves; hire purchase arranged; only a few at this price.—Hall, 91, Fore St., Edmonton. [7722]

**WIRELESS Portable Sets**, with 5 Cossor new process valves, for 9 guineas; less than components cost, comparable with any set double this price, Royalty paid; seen between 1 and 2 p.m., or particulars sent on receipt of stamped addressed envelope.—G. Hodgson, 53, Windsor House, Victoria St., Westminster. [7737]

**READ and MORRIS, Ltd.**, the mains pioneers, who in 1925 equipped the hospital with mains sets, still supreme in all-mains receivers and units.

**LOW Tension A.C. Eliminators**, permanently replacing batteries, now only £5/15; electrolytic condensers, 2,000 m.f., as used in above, 13/-; including postage.

**BARGAINS**—Second-hand sets, units, meters, speakers.—Read and Morris, Ltd., 31, Eastcastle St. (facing back of Warrings), Oxford St., W. [7769]

**OSRAM Music Magnet**, latest 1930, perfect, used a few hours only, £7/10.—Touchstone: Four, single dial, 60 stations, faultless, but no cabinet, 28/-; Bus Spot 66K, unused, 17/6; R.I. transformer, 5/-; P.625A, as new, 9/6; P.M.I.H.F., 5/-—51, Beechwood Av., Kew. [7766]

**SILVER Marshall Intermediate Unit**, including 4 valves, oscillator couplers and coils, 0.20 to 2,000 meters; £3/10.—W. V. Hughes, 7, North Rd., Caerparvon. [7765]

**PHILIPS Model 2514, 3-valve, A.C.**, absolutely unused; £17.—Box 4364, c/o *The Wireless World*. [7786]

**SPLIT New 1930 Osram Music Magnet and Orgola**, tested sets, Brown speaker; £7/10, £8/10, 35/-.—Box 4366, c/o *The Wireless World*. [7788]

**MAHOGANY 4-valve Radio Gramophone**, complete, wonderful tone and volume; write for demonstration; £35, cost £65.—Box 4365, c/o *The Wireless World*. [7787]

**F. W. SMURTHWAITE, A.M.I.R.E.**, manufacturer of all types of high grade radio apparatus, desires to announce that orders can again be accepted for reasonably quick delivery.

**ALL A.C. Receivers of Unique Performance**, radio-gramophone outfits, etc., specially made to your particular needs, all first class published designs quoted for, etc.

**WHATEVER Your Wireless Requirements may be**, my unbiased advice is at your disposal. I quote the lowest prices for guaranteed first class work; contractor to the B.B.C., Board of Guardians, etc.

**F. W. SMURTHWAITE, A.M.I.R.E.**, 15a, Onslow Gardens, Wallington, Surrey. 'Phone: Wallington 1982. Showrooms, 104, South End, Croydon. [7783]

**MARCONI 5-valve Receiver**, 2 S.G., Det., and 2 L.F., complete valves, extra coils, £10; speaker, extra; offers; demonstration.—Write F. K., 44, Lordship Park, N.16. [7780]

**SOLOBYNE Five (2 S.G.)**, complete in handsome mahogany cabinet; cost £20, for quick sale, £6/10.—4, The Drive, Edgware. 'Phone: 0626. [7772]

**WE Offer You the Following Inducements to Purchase Your New Receiver or Other Apparatus from us.**

**FIRSTLY**—Unbiased advice. The Principal of the firm has twenty years' professional wireless experience, having been at Government Experimental Stations in 1910. He has been Manager for the Sterling Telephone Co., radio expert to the G.E.C., and Chairman of the Technical Committee of the National Association of Radio Manufacturers. His advice has saved our clients many thousands of pounds, for, as everybody knows, there is no hobby on which more money is wasted on useless apparatus by the uninitiated.

**SECONDLY**—We take your old apparatus in part exchange for new. Send us a list of your old apparatus, or, better still, send us the apparatus, and state your new requirement. We will then make our offer for your goods, and if you do not approve, which is unlikely, we will return the parcel, carriage paid.

If you are in Doubt as to the Make of Receiver or other Apparatus you should Purchase, write to us, and we will advise you; we have no leaning towards any particular maker, and will tell you the particular instrument you should buy for your purpose.

**SCIENTIFIC DEVELOPMENT Co.**, 51, Fishergate, Preston. Tel.: 1364. [0226]

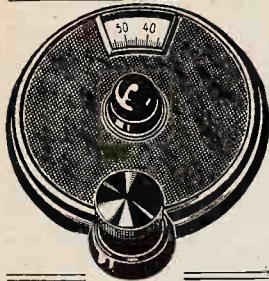

**BABY JUNIOR**  
2½" - 2/4  
**BABY**  
3" - 2/6  
**STANDARD**  
4" - 2/9  
In Black or Brown.

# "ISO" DIALS

"Iso" Dials have a definite grip. They do not slip.

**ISOMONA 70 PRECISION**

SIZE PRICE  
3" 4/-

**HAW & Co. Ltd.**

20, CHEAPSIDE, London, E.C.2. Tele.—CITY 9510. Sole Distributors for "Iso" Products. Coils, Units, Transformers, Chokes, Condensers, Trickle Chargers, Eliminators, etc.



Our 1930 Super Power Model.

## "THE MUSIC LOVER'S CHOICE."

Radio - Gramophone music and speech reproduced with amazing and uncanny realism. The most efficient speaker money can buy.

**BAKER'S 'selhurst' RADIO**

SEND TO-DAY FOR OUR FREE 36-PAGE BOOKLET "SOUND ADVICE."

Offices: 89 SELHURST ROAD, SOUTH NORWOOD, S.E.25. Works and Demonstration Room: 42 CHERRY ORCHARD ROAD, EAST CROYDON.

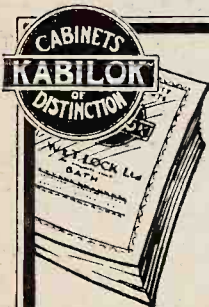

**BUILDING THE Mullard Orgola, Magic 3 or a set described in "Wireless World" or other radio publications?**  
Select a **KABILOK CABINET** of distinction. Illustrated Catalogue Free on request.

**W. & T. LOCK LTD.**  
ST. PETER'S WORKS - - - - BATH.  
LONDON: 11, Red Lion Square. W.C.1.

### Receivers for Sale.—Contd.

**SIMMONDS BROS.**—Receivers constructed to your own or any published design; also repairs, reconstructions; and modernisations at moderate charges; best materials and workmanship guaranteed; numerous testimonials; quotations free.—Address, Shireland Rd., Smethwick. [5882]

**SUPER** Range 3-valve Set, guaranteed, genuine, complete with all accessories, new; 9 guineas; approval 7 days.—Box 4377, c/o *The Wireless World*. [7828]

**KOLSTER-BRANDES** 169 All Mains 1930 Model, perfect condition, guaranteed, 13 guineas; also Stork speaker, as new, 40/—Box 4374, c/o *The Wireless World*. [7818]

**COSSOR** Melody Maker, 1929, S.G., Pentone Amplion, A.C.4, speaker, £7, or offers.—Box 4373, c/o *The Wireless World*. [7817]

**2-VALVE** Amplifier, output 25 milliamps, complete with valves, accumulator, charger, H.T. eliminator (200/220 A.C.); the lot £10, bargain.—19, Gairloch Rd., Eltham, S.E.9. [7807]

**MARCONI** V.1 Receiver, mahogany cabinet, valve, headphones, coils, accessories, 35/-; Dinkie L.S. 7/6.—Lawrence, Park Lodge, Holbeach, Lincs. [7798]

**3-VALVE** S.G. All-mains Transportable, for 100/250v. A.C., beautiful cabinet, amazingly selective and sensitive, superb reproduction, brand new; £22/10; demonstrated London area willingly, or sent on approval.—Heaton, 42, Green Lane, Thornton Heath, Surrey. [7797]

**PHILIPS** All-Electric 3-valve, with Celestion speaker; cost £28, just new; for quick sale, £20, or nearest offer.—McEwen, 17, Craven Rd., London, W.2. [7793]

**GREAT Opportunity.**—Having many requests for famous Royal Air Force 3-valve receivers, we have now procured limited number; these receivers give excellent loud-speaker reception, each set specially tested before delivery to ensure satisfaction, all are guaranteed brand new and perfect; the original cost of these sets was £18; special travelling case with each set; we are sacrificing at the absurdly low price of 32/6.

**GUARANTEED** and Absolutely New McMichael Supersonic Kits, including mahogany cabinet, book instructions, blue prints, clearance price only £3; these sets can get the whole world; without cabinet, price £2.

**J. B. HUMPHREYS** and Co., 23, College Hill, Cannon St., London, E.C.4. [7802]

**TRUVOX** Concert Grand, radio-gramophone, incorporating the famous 120-inch exponential horn, superseding moving coil, quite new, cost £55, wonderful instrument; reasonable offer accepted.—12, Wembury Rd., Highgate, London, N.6. [7808]

**BURNEDEPT** Superhet De Luxe, 7 P.M. valves, Brown Q15 loud-speaker, cost £91, all in excellent condition; seen any day after 6 p.m.; what offers?—Address: Bruzard, 9, Atherstone Terrace, Gloucester Rd., London, S.W.7. [7827]

**NATIONAL**, Portable, as new, £7/10; new battery.—Box 4379, c/o *The Wireless World*. [7830]

**PANATROPE** Super Cinema Model for Sale, cost recently £200, twin turntables, 3 power speakers, etc., in perfect condition, owner installed talkies; accept £95 for quick sale.—Box 4380, c/o *The Wireless World*. [7831]

**5-VALVE** Portable, new, list 21 guineas, sell £12; also 5-valve transportable in mahogany cabinet, complete, £4; also wireless surplus, cheap.—2, St. George's Rd., Bedford Park, W.4. [7835]

### ACCUMULATOR HIRE.

**DON'T** Buy Accumulators or Dry Batteries, join our C.A.V. low- and high-tension accumulator hire service, the largest and best in London; better and cheaper reception with no trouble; regular deliveries within 12 miles of Charing Cross; no deposit, payment on delivery or by subscription; over 10,000 satisfied users; explanatory folder post free; phone or write to-day.—Radio Service (London), Ltd., 105, Torrington Av., N.W.5. Phone: North 0623-4-5. [7596]

**C.D.E.S.** Accumulator Hire and Maintenance Service (5 mile radius).—98, Cherry Orchard Rd., Croydon. [6374]

### BATTERIES.

**WET** H.T. Replacements.—Sacs (capped or uncapped), highest grade, No. 1, 10d. per doz.; No. 2, 1/9 per doz.—See below.

**ZINCS.**—Best quality (wired), No. 1, 8d. per doz.; No. 2, 9d. per doz.; orders valued 5/- carriage paid, otherwise 6d. for postage.—British Battery Co., Clarendon Rd., Watford, Herts. [0258]

**PENTODE** Users.—Write for details of new size self-charging wet battery; 20,000 milliamps, 6d. per volt; illustrated catalogue giving data, post free.—U. Taylor, 57, Studley Rd., Stockwell, London. [0273]

**WET** H.T. Batteries.—Parts per dozen, jars, No. 1, 2¼x1½ square, 1/3; No. 2, 1/6; zincs, No. 1, 10d.; No. 2, 11d.; sacs, No. 1, 1/2 dozen; No. 2, 1/9; terminals, 8d., 10d.; dozen cells (18 volts), complete with bands and electrolyte, No. 1, 4/1; No. 2, 5/-; post 9d.; high efficiency, long life, self charging, upkeep small; send 6d. for sample unit; illustrated booklet free, carriage free order 10/-; write for free list wireless bargains, trade supplied.—W. Taylor, 57, Studley Rd., Stockwell, London. [0039]

## APPLICATIONS invited for POSITIONS AS REPRESENTATIVES by TELSEN ELECTRIC CO. LTD.

The positions are for whole time, and salary, commission and expenses will be paid.

Applications must state full detailed experience during the last seven years, age, number of years experience in car driving and remuneration required, also the particular area or district preferred, or, where best known.

Only first-class men with good references need apply.

All applications will be treated with strict confidence.

**TELSAN ELECTRIC CO. LTD.**  
Miller Street, BIRMINGHAM.

## Order Your 1930 "EVERYMAN FOUR" Metal Cabinet as described in "Wireless World," January 1st, 1930.



Eaton metal cabinet, with screened compartments. Delivery from Stock,

**46/6 each; Without Woodwork 35/-**  
Metal Cabinets for all "Wireless World" Sets in stock. Finished crystalline Brown, Black or Blue.

Trade Enquiries invited.  
Samuel Eaton & Sons (Manufacturers of Lighting Goods), 66/72, Barr Street, Birmingham.

## ENGRAVED ON THE TOP



—like the Terminals

The finishing touch that stamps Belling-Lee as the best. Completely insulated engraved top. The prongs, made of special spring metal, make a firm efficient connection. Entire flex—copper, rubber and braiding—individually gripped without use of tools.

**BELLING-LEE**  
FOR EVERY RADIO CONNECTION

Ask your dealer, or send to us, for Belling-Lee Handbook, "Radio Connections."  
Advertisement of Belling & Lee, Ltd., Queensway Works, Ponders End, Middlesex.

Mention of "The Wireless World," when writing to advertisers, will ensure prompt attention.

**CHARGERS AND ELIMINATORS.**

**VORTEXION** Transformers, chokes, etc., wound to any specification; write or 'phone for quotation; best quality components only.—Vortexion, 72, Merton Rd., Wimbledon, S.W.19. Tel.: Wimbledon 2814. [0319]

**TANTALUM** and **Lionium** for A.C. Rectifiers; make up your own inexpensive chargers; blue prints for H.T. and L.T., 1/- each; Lionium electrodes fitted with terminals, 2-3 amps. and 5-8 amps.—Blackwell's Metallurgical Works, Ltd., Speke Rd. Works, Garston, Liverpool. 'Phone: Garston 980 (2 lines). [6282]

**PHILIPSON'S** Safety High Tension Battery Eliminators.

**10/-** Down and the Balance in Easy Monthly payments secures the finest high tension supply available.

**PHILIPSON'S** Safety Eliminators are Guaranteed for 12 Months.

**PHILIPSON'S** Safety Eliminators are the Cheapest to Install and the Cheapest to Run; prices: Model A.C.5 £4/17/6, A.C.7 £3/17/6, complete with full wave, rectifiers; D.C.4 37/6, D.C.5 45/-.

**ALL** Models Obtained for 10/- Deposit; take advantage of this and get constant high tension immediately.

**WRITE** for Our Booklet, "Radio Power" to Philipson and Co., Ltd., Radio Engineers, Astley Bridge, Bolton. 'Phone: 2038. 'Grams: Safety, Bolton. Est. over 50 years.

**CHEBROS**—Chebros for all types of transformers and chokes, high grade instruments at a very moderate price; enquiries invited.—Chester Bros., 244, Dalston Lane, London, E.8. [5290]

**TRANSFORMERS** and Chokes for Battery Eliminators and for all wireless purposes, receiving or transmitting; enquiries invited.—Chester Bros., 244, Dalston Lane, London, E.8. [7587]

**FEL-ECTRIC** High Tension Eliminator Kits, improved output 15 milliamps at 120 volts; complete; 25/-.

**FEL-ECTRIC** Eliminator Kits are the Best and cheapest in England; complete, 25/-.

**FEL-ECTRIC** Kits are Complete, except valve, and we recommend Philips 373; 15/-.

**FEL-ECTRIC** Kits have been Sold in Hundreds, and are guaranteed, satisfaction or money returned.

**FEL-ECTRIC** Kit will be sent c.o.d. if desired, state voltage and periods, also whether Philips valve is required at 15/- extra.

**FEL-ECTRIC** Eliminator Kit is Post Free; price 25/-.

**FOLDER** and Lists on Request to Fel-Ectric Radio, 56, Garden St., Sheffield. [7742]

**PHILIPS** Charger, 12 volts 1.3 amps., 200 volt 50 cycle; £2/10.—Nichols, 74, Childbeart Rd., Balham. [7762]

**SAVAGE'S** Specialise in Wireless Power from the Mains, reliable apparatus at reasonable prices. **SAVAGE'S** Transformer Laminations and Bakelite S. Hobbins; intending home constructors should write for list.

**SAVAGE'S** Reliable Smoothing Condensers.—1,000 volts D.C. test, 2 mid. 3/-, 4 mid. 5/3; 500 volts D.C. test, 1 mid. 1/6, 2 mid. 2/3, 4 mid. 3/8.

**SAVAGE'S** Super Smoothing and Output Chokes.—Many types available, write for list.

**SAVAGE'S** Mains Transformer for Westinghouse Rectifiers.—H.T.4, 19/6; A3, 17/-; A4, 20/-.

**SAVAGE'S** Mains Transformer for Westinghouse H.T.4 Unit, with additional winding, 4 volts 3 amps.; 23/-.

**SAVAGE'S** Mains Transformer.—V.T.31, 200-0-200 volts 60 m.amps, 2+2 volts 2 amps., 2+2 volts 3 amps.; 28/-.

**SAVAGE'S** Mains Transformer.—B.T.3 500-0-500 volts 120 m.amps., 3.75+3.75 volts 3 amps., 3+3 volts 3 amps., 2+2 volts 3 amps.; 51/-.

**SAVAGE'S** Mains Transformers and Power Chokes are carefully and individually constructed from first class materials with an exceptionally generous margin of safety.

**SAVAGE'S**, 146, Bishopsgate, London, E.C.2. 'Phone: Bishopsgate 6998. [6808]

**REGENTONE** Eliminator A.C. W.I.B.S.G., 200-250, 40-60, new, unused; 70/-, cost 100/-.—Bailey, 28, Birchwood Rd., West Byfleet, Surrey. [7822]

**RECTIFIER**, output 300 milliamps at 200 volts, input 230 volts, 50 cycles, full smoothing equipment, Ediswan H.M. 235X valve, cost £10, guaranteed perfect condition; £5/10.—186, Normandy Rd., Handsworth, Birmingham. [7789]

**CABINETS.**

**ARTCRAFT** Radio Cabinets are Britain's Best Value. [0313]

**DIGBY'S** Cabinets.—Table models in solid oak and mahogany; from 11/6 to 71/-.

**DIGBY'S** Cabinets, fitted with Radion or Resiston ebonite if required.

**DIGBY'S** Cabinets.—Pedestal model, with separate battery components; from 58/- to £12.

**DIGBY'S** Cabinets Made to Customer's Own Designs.

**DIGBY'S** Cabinets.—Write for new 16-page art catalogue.—F. Digby, 9, The Oval, Hackney Rd., E.2. 'Phone: Bishopsgate 6458. [0128]

**ARTCRAFT** Radio Cabinets are Britain's Best Value. [0309]



**THE SET THAT CUTS OUT BROOKMANS PARK**

Tests made in various parts of the country prove the amazing selectivity of the Climax All-electric Chelloset. Definitely eliminates Brookman's Park, yet maintains full volume. It costs less than £10, yet these are among its many important features: one dial tuning—dual wave switch to eliminate coil changing—Westinghouse metal rectifier—volume control. No batteries whatever—it operates entirely from A.C. Mains. Walnut finished cabinet.

**£9.17.6** COMPLETE

Complete with valves, royalties, and full mains equipment.

**IMPROVED MAINS UNITS**

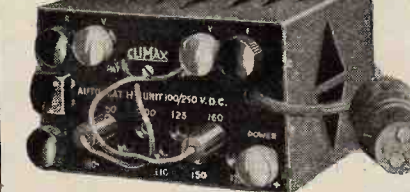

**IMPROVED D.C. MAINS UNITS** For H.T. Mains. The most popular D.C. Mains Unit on the market. Has **TEN VOLTAGE TAPPINGS**—50, 60, 75, 100, 110, 125, 150, 160, 175 and 200. Output 50 m/a total, 10 m/a tappings.

**34/-** COMPLETE

**IMPROVED A.C. MAINS UNITS.**

A.C. Models have new metal rectifying units eliminating all valve trouble. Negligible upkeep costs. **TEN VOLTAGE TAPPINGS.** For all Mains voltages 40/100 cycles. A.C. Model U.20, Price £4/5/0 up to 120v. H.T. up to 20 m/a. A.C. Model U.50, Price £5/15/0 up to 200v. H.T., up to 50 m/a. Obtainable from all radio dealers.

**CLIMAX**  
**A YEAR AHEAD**  
CLIMAX RADIO ELECTRIC, LIMITED,  
Haverstock Works, Parkhill Road, Hampstead,  
London, N.W.3. Telephone: Primrose 1171-2

**Cabinets.—Contd.**

**ARTCRAFT** Radio Cabinets; Britain's best value; lowest prices consistent with highest quality; illustrated list free from actual manufacturers.—Artcraft Co., 156, Cherry Orchard Rd., Croydon. 'Phone: Croydon 1981. [0040]

**CABINETS**, 16 1/2 in. x 7 1/2 in. x 11 in., hand mahogany finished 7/6, unpolished 5/6; oval front, 10 1/2 in. x 6 1/2 in., 6d. extra; portable cabinets, 16 1/2 in. x 16 1/2 in. x 8 in., £1/5; baseboard, 6d.; carriage free.—F. W. Ramsey, 63, Shaftesbury St., London, N.1. Clerkenwell 7139. [7584]

**ARTCRAFT** Radio Cabinets are Britain's Best Value. [0311]

**KAY'S** Cabinets, the greatest range of pedestal cabinets in the kingdom; original creative designs at prices 50% lower than elsewhere; quotations for specials by return; delivery at short notice guaranteed; moving coil, portable, baffle, vignette, radiogram, electric pick-up, television, etc.; illustrated lists free.—H. Kay, Wireless Cabinet Manufacturer, Mount Pleasant Rd., London, N.17. 'Phone: Walthamstow 1626. [7745]

**ARTCRAFT** Radio Cabinets are Britain's Best Value. [0310]

**COILS, TRANSFORMERS, ETC.**

**WIRE-WOUND** Non-inductive Resistances of all sizes, guaranteed, 600 and 1,000 ohms, 1/3; 25,000 ohms, 2/6, etc.; H.F. chokes, ebonite formers, silk covered, wire-wound, guaranteed 2,000 turns, 2/6 binocular type, 4/6.—Omnivox Products, 20, Brooke St., Holborn, E.C.1. [7727]

**NEW Kilo-Mag** Four Coils, 37/6 set; ebonite formers (slotted), for winding, 12/6 set of 3; all post free; trade supplied.—Groves Bros., St. Mary's Place, Shrewsbury. [7750]

**FERRANTI** A.F.5C, 20/-; O.P.30, 15/-; R.I. mains, suitable for 2 L.S.5A.s, £2; 1928 Everyman Four coils, 20/- pair.—Nichols, 74, Childbeart Rd., Balham. [7761]

**IGRANIC** Transformers, E and F, 15/- pair, bargain.—40, Harrington St., Regent's Park, N.W. [7777]

**SIMMONDS BROS.**—Bercliff coils, Record Three, 50/- pair; new kilo-mag four, 50/- set; foreign listeners four, low, 30/-; long wave, 37/-; screened grid Regional, 40/-; Mullard S.G.P. dual range coils, 30/- pair; Bercliff standard coils, for new all-wave four, standard four, A.C. three, Everyman four, etc., 63/6 set of 4, with bases; the same coils for the Lodestone series ("Wireless Magazine"), 65/9 set of 4, with bases; Titan unit, 15/-; decoupling resistances, 600 ohm, 1/6; 1,000 ohm, 2/-; all "Wireless World" and similar coils in regular production by the leading specialists; list free; trade supplied.—Simmonds Bros., Shireland Rd., Smethwick, Tel.: Smethwick 751. [6314]

**600-OHM** Decoupling Resistances for New Kilo-mag Four, foreign listeners' four, and all "Wireless World" circuits, hand made and tested in our own workshops; improved model wound with Constantan wire, 1/6 each, post free.—Groves Bros., St. Mary's Place, Shrewsbury. [7832]

**1,000-OHM** Decoupling Resistances for "Wireless World" Circuits; 1/6 each, post free.—Groves Bros., St. Mary's Place, Shrewsbury. [7833]

**FOREIGN** Listeners' Four Boxes, 19/- set of 4; coils, 37/6.—Stott.

**RECORD III** Coils, 35/-; Kilo-Mag 4 coils, 35/-; decoupling resistances, 1/3.

**KIT** Set Coils and Switches, 37/6; dials and plates, 5/- pair.—Stott.

**1930** Everyman Coils, 42/6 set; all special parts to order; trade supplied.

**S.G.** Short Wave III Set of 4 Coils; 20/-.

**METAL** Cabinets, in oak or mahogany, with moulded wood top and base; Record III, K.M., and 1930 Everyman, 45/-; Kit set, 35/-; metal box only, 32/6 and 27/6 respectively.—Arthur T. Stott, 11, Duke St., Rochdale. [7834]

**DYNAMOS, ETC.**

**STAGGERING** Value! in Dynamos and Switchboards. —Guaranteed, modern totally enclosed ball bearing type, 16-20-volt 10 amp. charging and lighting dynamo, with driving pulley and slide rails, together with beautifully polished teak switchboard, fitted with ampere meter, main switch, double fuses and automatic magnetic charging cut-out; written guarantee given (only few left); better wire if you wish to secure set; £3/19/6; switchboards (if separate) £1/5.—Universal Motors, St. James Rd., Derby. [7792]

**GRAMOPHONE PICK-UPS, ETC.**

**ELECTRIC** Pick-up, with arm, adaptable to any gramophone; pick-up 14/-, arm 7/-; c.o.d.; remarkable value.—G. Hodgson, 53, Windsor House, Victoria St., Westminster. [7738]

**BURNDIPT** Pick-up, very little used, excellent condition.—Smith, Norwood Rd., Tiverton, Devon. [7764]

**R.I.-VARLEY**, with Mellotron arm, 35/- approval.—Redgewell, "Penrhyn," Chartfield Rd., Reigate, Surrey. [7774]

**CELESTION** Woodroffe Pick-up, 21/-; Amplion Pick-up, 9/-; slightly used.—Box 4371, c/o The Wireless World. [7815]

**R.I.-VARLEY** Compound Mass Suspension Pick-up, a new, cost £3/5, 19/6.—Ingham, "Chestnuts," Church Lane, Walthamstow, London. [7816]

### SUPER-MICROPHONES

New, highly sensitive, made on the latest principle, a vast improvement over all other types; will pick up whispered words from a distance of several yards, also strongly amplify and transmit speech and music over a distance, through Loud-speaker or Headphones. Splendid instruments for making Detectaphone, DEAF AID, LOUD-SPEAKING TELEPHONE. Announcements through Loud-speaker, Amplifier for Crystal or Valve Sets. Electric Sound Detector, Experiments.

NO OTHER MICROPHONE OF EQUAL SENSITIVENESS KNOWN; each instrument finely black enamelled and fitted with a 3-ft. silk connecting cord. Despatched by return post. **8/6**

#### "BABY ALARM"

By suspending Super-Microphone over or near baby's cot and connecting through Microphone Transformer to Loud-speaker every sound in bedroom is reproduced with great volume at any distant point.

SPECIAL MICROPHONE TRANSFORMER for connecting Super-Microphone to Radio Head-phones, Loud-speaker, Valve Set, or Valve Amplifier **6/-**

#### SMALL 10 OHMS EARPIECE

for use with Super-Microphone as a HIGHLY EFFICIENT DEAF AID, or Detectaphone, etc.; thin 3-ft. silk connecting cord fitted. Earpiece finely black enamelled **6/-**  
Full Directions for use of Super-Microphone for many purposes and diagrams of connections free.

### NEW PUBLIC ADDRESS MICROPHONE

The Ideal Instrument for addressing an Audience through Loud-speaker (via Valve Amplifier or L.F. Stages of Wireless Set), and for relaying Speech and Musical Entertainment to any distance. Powerful Loud-speaker Reproduction with perfect Fidelity.

#### Hand Type,

highly distance-sensitive, yet guaranteed entirely free from distortion or microphonic noise, absolutely silent background; far superior to ordinary Microphone Transmitters and obsolete Government surplus; for use with Valve Amplifier or Valve Set (through leads of Gramophone Pick-up if desired) at Open-air Meetings, in Cinema, Theatre, or Concert Hall. Operates from 3 Volt Tapping of L.T. Accumulator, through Microphone Transformer. Current consumption one-tenth Ampere. Provided with detachable Sound Collector, handle, hook for suspension, and a 9-ft. silk connecting cord, as illustration. **16/-**

Microphone Transformer for the above **6/-**  
DIAGRAM OF CONNECTIONS FREE.

FREDK. ADOLPH, Actual Maker, 'Phone: MUSEUM 8329  
27, Fitzroy Street, London, W.1.

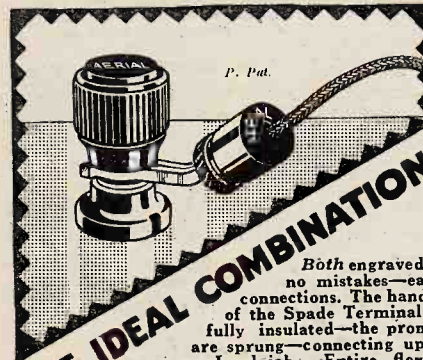

**THE IDEAL COMBINATION**  
Both engraved—no mistakes—easy connections. The handle of the Spade Terminal is fully insulated—the prongs are sprung—connecting up is a one-hand job. Entire flex—rubber, copper, and braiding—individually gripped without use of tools.

Ask your dealer, or send to us for Belling-Lee Handbook, "Radio Connections."

Price **4 1/2 d.**

**BELLING-LEE**  
FOR EVERY RADIO CONNECTION

Advertisement of Belling & Lee Ltd.,  
Queensway Works, Ponders End, Middlesex

### BONA FIDE TRADERS' GUIDE.

Send for our comprehensive Illustrated List.  
QUICK SERVICE QUICK SERVICE.

### THE QUALITY HOUSE.

PERSEUS MFG. CO., LTD. (Dept. W.W.),  
BRANSTONE RD., BURTON-ON-TRENT.

### LOUD-SPEAKERS.

EPOCH Moving Coil Speakers.  
EPOCH.  
EPOCH.  
EPOCH.  
EPOCH.  
EPOCH.  
EPOCH Moving Coil Speakers Speak for Themselves.  
EPOCH.  
EPOCH.  
EPOCH.  
EPOCH.  
EPOCH.  
EPOCH.—Test an Epoch against any other make. It will persuade you more than the best salesman.  
EPOCH.  
EPOCH.  
EPOCH.  
EPOCH.  
EPOCH.—Ask any of the thousands of users of even the older models. But this season's models? Well, let the speakers tell you themselves.  
EPOCH.  
EPOCH.  
EPOCH.  
EPOCH.  
EPOCH.  
EPOCH.—Please to test them against any or every make on the market—preferably with a quick switch over  
EPOCH.  
EPOCH.  
EPOCH.  
EPOCH.  
EPOCH.—Order one for 7 days' free trial.  
EPOCH.  
EPOCH.  
EPOCH.  
EPOCH.  
EPOCH.—Your deposit instantly refunded in full if you are not more than satisfied. No catch. No red tape.  
EPOCH.  
EPOCH.  
EPOCH.  
EPOCH.  
EPOCH.—The most comprehensive range of moving coil speakers in the world.  
EPOCH.  
EPOCH.  
EPOCH.  
EPOCH.—Send for catalogue W.S.2.  
EPOCH.  
EPOCH.  
EPOCH.  
EPOCH.  
EPOCH.—16 pages crammed full of real information. Post free.  
EPOCH.  
EPOCH.  
EPOCH.  
EPOCH.  
EPOCH RADIO MANUFACTURING Co., Ltd., are the manufacturers. City Office and Service Station, 3, Farringdon Avenue (Ludgate Circus end), E.C.4. 'Phone: Central 1971 (2 lines). Private Branch Exchange. [7754

# STUPENDOUS!

A recent advertiser in "THE WIRELESS WORLD" writes as follows:

"As the results from my advertisement in 'The Wireless World' were stupendous, I shall be glad if you will cancel my advertisement in next week's issue as I am cleared out.

I might add that 'The Wireless World' is the best journal I have read."

W. F. Macbeth,  
"Bramar,"  
Ballymena, Ulster.

w.w.89.

# So Many Replies!

A recent advertiser in "THE WIRELESS WORLD" writes as follows:

"I HAVE received so many replies to my advertisement in 'The Wireless World,' which appeared under a Box Number that I am sending herewith stamps to the value of 6d. as further payment towards your postage expenses. Thanking you for the quick despatch of all replies."

R. W. CAPEWELL,  
52, Chapel Terrace,  
Trent Vale,  
Stoke-on-Trent.

W.W.88.

# H. & B. Service for You.

If it's Kits it's H. & B.

We specialise in kits for all circuits described in this and other Radio Journals.

## S.G. Short Wave!!!

Complete kit of specified parts, including a Trelleborgs Panel and Strip ready drilled, base-board, wire and screws.

Cash price **£8 - 18 - 0**

or supplied on our Gradual Payments System, **38/-** down and 10 monthly payments of **15/5**.

3 Mullard or Cossor Valves **45/-** extra.

Write for detailed price list of this kit.

**Buy the H. & B. Way.  
It's Easier It's Better**

No References. Strictly Confidential.

**Climax All-electric A.C. Chelloset.** One-dial tuning, dual wave, amazingly selective. In walnut cabinet. Cash price, **£9 17s. 6d.**, valves included; or **£2** down and 10 monthly payments of **17/6**.

**Cossor 1930 Battery Kit,** complete with cabinet, valves, and full instructions. Cash price, **£8 15s.**; or **16/-** down and 11 monthly payments of **15/10**.

**Pye Popular Two.** Remarkably efficient two; one-dial tuning, dual range. Cash price, **£4 17s.**; or **15/-** down and 10 monthly payments of **9/-**.

**Amplion A.C.4.** Oak cabinet speaker. Splendid tone, handsome appearance. Cash price, **£3**; or **15/-** down and 5 monthly payments of **10/-**.

**M.P.A. Popular Cabinet Speaker.** Oak cabinet. Cash price **45/-**; or **5/-** down and 9 monthly payments of **5/-**.

**Ekco A.C. Eliminator.** 3.F.20, S.G., 600-120, 120/150. **10/-** down and 8 monthly payments of **9/8**.

**Ultra Air Chrome Speakers,** 14 by 14. Cash price **52/-**; or **11/-** down and 4 monthly payments of **11/-**.

**Climax Eliminator, D.C.** Suitable for any set up to 5 valves. Has 9-volt. tapings. Cash price **34/-**; or **7/-** down and 5 monthly payments of **6/-**.

**Climax A.C. Eliminator.** Suitable for all voltages. Has ten tapings. Cash price **85/-**; or **10/-** down and 8 monthly payments of **10/-**.

**H. & B. 1930 115-page Catalogue** now ready, price **9d.** Refund on first order over **5/-**.

Carriage Paid on all orders. C.O.D. Charges Paid over **£1**.

WE CAN SUPPLY ANYTHING RADIO.

## H. & B. RADIO Co.

34, 36, 38, BEAK ST., REGENT ST., LONDON, W.1

'Phone: Gerrard 2834.

Loud-speakers.—Contd.

BAKER'S

BAKER'S

SELHURST RADIO Moving Coil Speakers are of the Highest Grade and Proved Efficiency.

BAKER'S

BAKER'S

SELHURST RADIO Moving Coil Speakers Obtained on 14 Days' Approval for Comparative Test.

BAKER'S

BAKER'S

SELHURST RADIO Moving Coil Speakers Used by Music Lovers Throughout the World.

BAKER'S

BAKER'S

SELHURST RADIO Moving Coil Speakers.—Write now for new 36-page booklet, "Sound Advice."

BAKER'S

BAKER'S

SELHURST RADIO Moving Coil Speakers Reproduce both Speech and Music with Wonderful Realism.

BAKER'S

BAKER'S

SELHURST RADIO Moving Coil Speakers can Always be Heard at the New Demonstration Room.

BAKER'S

BAKER'S

SELHURST RADIO Moving Coil Speakers.—The new 36-page booklet is full of truthful information

BAKER'S

BAKER'S

SELHURST RADIO Moving Coil Speakers are the Best that Money can Buy; ideal New Year presents.

BAKER'S

BAKER'S

SELHURST RADIO, the leading manufacturers of high grade coil speakers.

OFFICE: 89, Selhurst Rd., South Norwood, S.E.25. 'Phone: Croydon 1618. Works and Demonstration Room (always open): 42, Cherry Orchard Rd., East Croydon (15 minutes non-stop Victoria or London Bridge). [0231

# KUSHETTE PICK-UP ARM

A new Arm for Radio-Gramophones where price is a consideration: functions perfectly, and is more efficient than a cheap tone arm. Suitable for Portables or for use with existing Tone Arms to avoid removal of Sound Box.



Price **5'9**

Weight-relieving—adjustable. Lifts out from base: lies flat: correctly angled for best alignment: bushed bearing: no vibration: well finished in aluminium.

R. H. GLASSCOE & CO.,  
71, MOORGATE, E.C.2.

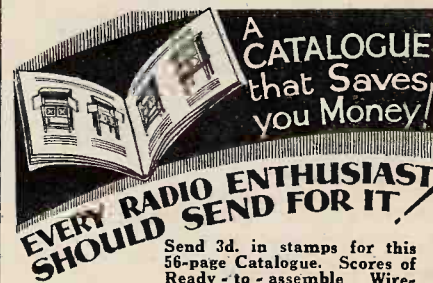

Send 3d. in stamps for this 56-page Catalogue. Scores of Ready-to-assemble Wireless Cabinets and Special Osborn Offers.

**CHAS. A. OSBORN** (Dept. W.W.),  
The Regent Works, Arlington Street, London, N.1.  
Telephone: Clerkenwell 5095. Open to 7.30 p.m. Saturdays 4.30 p.m.  
And at 21, ESSEX ROAD, ISLINGTON, N.1. Open until 8 p.m. 9 p.m. SATURDAYS. 'Phone: Clerkenwell 5634.



SWITCH ON for **£2. 7. 6**

No bother, no more batteries to buy, in fact "trouble free" radio, always perfect reception at a touch of a switch.

You can buy a mains unit all ready to connect up, or you can have components complete with blue print to build into your present set. Use the electric mains and get better radio in every form.

**THE TULSEMERE MFG. CO.,**  
1-7, Dalton Street, West Norwood, S.E.27  
Telephone: Streatham 6731.

## RADIO-GRAMOPHONE CABINETS

Beautifully finished in highly polished OAK.

Will take sets  
18" x 7" x 16" or 21" x 7" x 16".  
Spacious compartment for speaker and batteries. Overall size 36" x 24" x 19".  
9-ply motor board.

£4-19-6

(Mahogany Finish £5-15-0.)  
Delivered free in England and Wales. Scotland 2/6 extra.

Send for our Illus. Catalogue.  
Fitted complete with D.S. Motor, B.T.H. Pick-up and Arm, Ormond Unit and Chassis... £9-17-6

This is all you need to turn your present set into a modern RADIO-GRAMOPHONE.

### PREMIER SUPPLY STORES

Radio & Gramophone Specialists,

165, Fleet St., London, E.C.4.

'Phone: Central 2833

Large selection of Gramo. Motors and Pick-ups always in stock

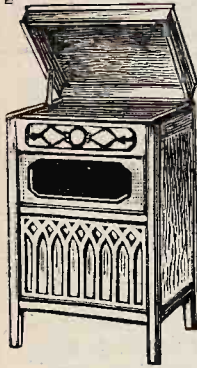

These Cabinets are made by experts and are thoroughly electrically sealed with Fine Brass Gauze.

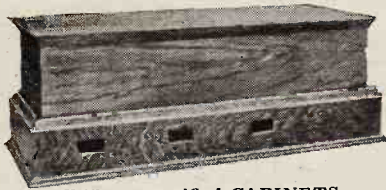

W. W. as specified CABINETS.  
**RIGBY & WOOLFENDEN,**

Sheet Metal Workers,

Milnrow Road, ROCHDALE.

'Phone 2948.

## ELEX

2DH

2DS



SPADES and PINS  
HOOKS and EYES

6 Colours .. 2d. each.

2DP



Write for List X92

J. J. EASTICK & SONS,  
118 Bunhill Row, London,  
E.C.1.

2DI



## REPAIRS

Any make of L.F. Transformer, Loudspeaker or headphones repaired and dispatched within 48 HOURS—TWELVE MONTHS' GUARANTEE with each repair. 4/- Post Free.

Terms to Trade.

**TRANSFORMER REPAIR CO.,**

Dept. W.

214, High Street, Colliers Wood, London, S.W.19

## PAREX



**Bakelite Drum Dials**  
with Escutcheons

**5/6**

(from stock).

Cabinets, Coils, Valve Holders, etc., for New Kilo-Mag 4 and 1930 Everyman 4.

Order direct from:

**E. PAROUSSI,**

10, Featherstone Buildings, High Holborn, W.C.1

'Phone: Chancery 7010.

### Loud-speakers.—Contd.

**MARCONIPHONE** Popular Horn Loud-speakers, adjustable unit, dark mahogany crystalline finish, absolutely new, in makers' original sealed boxes; formerly 42/-; clearance price 15/- each, postage 1/-.—F. J. A. Hall, 91, Fore St., Edmonton, N.18. [7720]

**NEW B.T.H.** C2, 35/-; Amplion A.R.9, 27/-; Amplion A.R.19, 25/-; Amplion A.R.65, 25/-; A.R.19 and A.R.65, horns slightly damaged.—Box 4287, c/o *The Wireless World*. [7726]

**BARGAIN**—Amplion cone, new 1928; £3/15, sell £1/17/6; carriage paid.—Wayre, Brackendale, Lovelace Rd., Surbiton. [7757]

**CONE** Speaker, B.T.H. unit, excellent tone; cheap—38, Methuen Park, Muswell Hill. [7767]

**GOODMAN** Moving Coil, £2; 3ft. ornamental baffle, 25/-—Nichols, 74, Childerburt Rd., Balham. [7763]

**BRANDS** Elliptic cone, £2; Celestion C12, £3; mahogany cases, in new condition.—Marshall, Rose, Hill, Ilfley, Oxford. [7782]

**MAGNAVOX** 230 A.C. Moving Coil Speaker, all mains; cost £11/11, sell £6; perfect working order, heard any time.—Brooklands, Moor Lane, Great Crosby, near Liverpool. [7784]

**GREAT Bargains.**

**GREAT Bargains.**

**GREAT Bargains.**—Epoch model A moving coil speaker kit (or complete units), brand new; a large number of these famous instruments made for a special order for use in talkies, but not executed, for credit reasons only; regular prices, £3/10, £4/2, and £5/17/6, to clear at 50/- for accumulator operation, 55/- for D.C. mains operation, 85/- for A.C. mains; kits comprising copper plated super magnet-pot (weight 23 lb.) Crystalline frame, fully adjustable, moving coil, any impedance, paper, leather and mounting rings, made up complete, if desired, 6/- extra.

**GREAT Bargains.**

**GREAT Bargains.**—In fact, the greatest bargains ever offered! A number of Epoch model A used kits at given away prices, guaranteed in perfect working order; early 1928 model, 35/-; latest model, 42/6; made up complete, if desired, 6/- extra.

**ENJOY** Marvellous Epoch Reproduction at Ridiculous Cost; don't wait until they are all gone, but secure one immediately by writing, phoning, telegraphing, or hurrying to Epoch, 5, Farringdon Av., E.C.4. [7077]

### TRANSMITTERS.

**CHEBROS.** Chebros. Chebros transformers and chokes of all descriptions, special transformers for transmitting and modulation; choice a speciality; enquiries invited.—Chester Bros., 244, Dalston Lane, London, E.8. [5240]

### VALVES.

**AMPLIFIER** Valve.—If you require power you cannot do better than one of these:—

**FILAMENT** Volts 6, plate volts 400 (maximum), grid bias 84 volts (approx.), impedance 800 ohms., amplification factor 3.8, mutual conductance 4.35 m.a./volts; price £5/10; see article "The Wireless World" 24th July, 1929, then send to North London Valve Co., Ltd., 22½, Cazenove Rd., Stoke Newington, London, N.16. [7702]

### COMPONENTS, ETC., FOR-SALE.

**BELLING-LEE** Panel Fittings are designed to give an expert finish to any home-constructed set; catalogue post free.—Belling and Lee, Ltd., Queensway Works, Ponders End, Middlesex. [0018]

**POWER** Chokes, substantially built, for smoothing circuits in eliminators dealing with currents 100-300 milliampères, inductance 30 henries; 8/6 each; guaranteed 12 months.—Transformer Repair Co. (Dept. W.), 214, High St., Colliers Wood, S.W.19. [0327]

**WESTON** Model 301, milliammeters, ammeters, and voltmeters. 21/- each; hot wire ammeters 0-1 amps., 4/-; 0-0.5 amp., 3/-; instrument repairs and alterations; send for list.—The Victa Electrical Co., 47, High St., Battersca, S.W.11. Established 1910. [7563]

**POTENTIAL** Dividers 10,000, 15,000, 20,000, 25,000 and 30,000 ohms, 5 variable tappings; 2/- each.

**POTENTIAL** Dividers, heavy duty, wire wound, 15,000 and 20,000 ohms, 7 tappings, 5/6; 4 tappings, 3/9.

**CONDENSERS**, 2 mfd., 2/3; 4 mfd., 4/-; guaranteed; tested 500 volts.

**CHOKES** (L.F.)—Excellent for smoothing, up to 20 milliamps, 2/-; special heavy duty, 100 milliamps, 3/6.

**ELIMINATORS**, A.C. wired for half or full wave, complete with valve; £3/17/6.

**H.F.** Chokes; 3/-.

**GRAMOPHONE** Motors, well known make, double spring, silent, complete with fittings; 30/-.

**SPECIAL** Bargain.—B.T.H. 40 henry chokes; 9/6; any article on approval against cash.—Huggins, Radio Engineer, Clacton-on-Sea. [7398]



# TUNING COILS and METHODS of TUNING.

By W. JAMES.

A VERY useful manual giving the maximum of information on the subject. Following a simple explanation of the principles of wireless, the author discusses the many methods of tuning circuits, with explanations of spade, condenser and variometer tuning. Other chapters treat in detail of the choice, construction and design of coils, and give particulars as to size of coil required, the best shape, size of wire, type of insulation, and special uses of the various coils.

Price 2/6 net.  
By Post 2/10.

From leading booksellers or direct from the Publishers:

ILIFFE & SONS LIMITED,  
Dorset House, Tudor Street,  
LONDON,  
E.C.4.

W.W.32.

Mention of "The Wireless World," when writing to advertisers, will ensure prompt attention.

B48

Components, Etc., for Sale.—Contd.

**600 OHMS** Decoupling Resistances; see advt. under Coils.—Groves Brothers, Manufacturers. [7751]  
**AMPLION LION** L18 Power Chassis, new condition, £5/5; Burndept pick-up, 14/-; Beamer pick-up carrier, 5/-.—Gordan, 74, Delancey St., Regent's Park, N.W.1. [7781]  
**PICK-UP** Igranite, unused, 16/-; Ormond unit, 8/-.—Austen, 60, Vaughan Rd., Harrow. [7785]  
**SLIGHTLY Used** only, and guaranteed.—Fultograph picture receiver, complete with extras, £6; Igranite type G output choke, 15/-; Igranite tapped output choke, 13/-; Lissen L.F. chokes, 2/-; R.I. Varley filter choke, 13/-; Marconi 110 henry choke, 10/-; Pye 110 ditto, 8/-; all postage extra.—Scientific Development Co., 51, Fishergate, Preston. [7779]  
**CRESCENT** Mullimeter, five ranges, 30/-; 8 short wave coils, 7/6.—Hanson, Verwood, Dorset. [7775]  
**YOUR Old** Components Taken in Part Payment for Latest Type; see our advert. in column Receivers for Sale.—Scientific Development Co., 51, Fishergate, Preston. [0228]

**WIRELESS** Transmitting Sets for Morse Telegraphy or distant Control of Models, etc., in spark coil, condenser, spark gap, helix, etc., very compact, complete and ready for use, 12/6; high note buzzer with heavy Morse key, very high quality, 7/6.—Below.  
**ELECTRIC** Motors, 1/4 h.p. to 1/2 h.p., 110v. and 220v. D.C., silent running, carbon brushes, in perfect condition and working order, suitable for gramophones, television, or any small power uses, 10/-; a few with overheated windings, if rewound make good dynamo for H.T. accumulators, 6/-.—Below.

**COMPLETE** Portable Telephones, ready for use, high class instruments, 17/6; hand telephones, 4/6; 1,000 ohm choke coils, 1/-; Dewar switches, 1/-; large earphones, 1/3; Morse keys, 4/-.—Below.

**HIGHLY** Sensitive Microphones for Transmission of Speech or Music or Sensitive Amplifying, 2/6; microphone transformers to suit, 2/6; microphone buttons, 1/-; G.P.O. relays, 2,000 ohms, very sensitive, very low operating current, 6/6.—Below.

**2 IN.** Spark Coils, 11in. x 7in. x 6in., complete with contact breaker and condenser, 12/6; lin. spark coils, 4in. x 4in. x 5in., fully complete, 6/-; Ford ignition coils, 1/4 in. spark, complete, 4/-.—Below.

**DYNAMOS**, shunt wound, for charging or lighting, 50v. 4 amp., ring oiler bearings, carbon brushes, 35/-; 100v. 3 amp., ditto, 50/-; 110v. 3 amp., ball bearing, carbon brushes, 55/-; 110v. 2 amp. ditto, 45/-.—Below.

**ELECTRIC** Motors, all ball bearing and carbon brushes, 1/4 h.p. to 1/2 h.p., 110v., 30/-; 6-volt car starter motors, 10/-; 12-volt ditto, 12/6; 110v. motor direct coupled to air blower, mounted on iron bed-plate, 1/4 h.p. motor, 45/-.—Below.

**STARTERS**, please state requirements; starter regulators make good field rheostats for dynamos, to carry 2 amps., 7/6, to carry 5 amps., 10/-, to carry 8 amps., 12/6.—Below.

**ALL** Above Goods Guaranteed, cash with order, or c.o.d. all goods 3 days' approval from date of delivery; all letters answered.—Galpin, Binfield Heath, near Henley-on-Thames. [7809]

**FERRANTI** Trickle Charger, 30/-, little used; many modern components; state requirements.—Dick, Alvechurch, Worcestershire. [7806]

**UNUSED** Osram H210, 8/-; Ormond 4-pole adjustable, 9/-; R.I. Varley R.C.C. unit, 6/-.—Small, 64, Hockley Hill, Birmingham. [7805]

**SALVAGE** Stock, all sound.—Ten Varley push-pull output transformers, 12/- each; 10 Pye L.F. chokes, various, 8/- each; M.H. 7-valve superhet, no cabinet, 50/-; 10 Ferranti milliammeters, various, 20/- each; 15 Brownie transformers, 6/- each.—Franks, 42, St. George's St., London, E.1. [7821]

**RADIO HOUSE**, Huddersfield, issues the Reliability Wireless Guide, which will be sent post free upon request by Messrs. J. H. Taylor and Co., 15, Macaulay St., Huddersfield. [7823]

**ONE** Unused Amplion Lion Chassis, £6, accept 75/-; Ferranti unused trickle charger for A.C. mains, 100-130 volts, 32/6; 1 Lewcos aerial and 1 split primary coil, cost 36/- pair, accept 17/6 pair; all above as brand new and unused.—Green, 16, Corporation St., Chesterfield. [7822]

**TRIPLE** Gang Condenser, 0.0005 (Cylidon); cost £3/10, 40/-, offers.—Maxted, 71, Chaplin Rd., Stapleton Rd., Bristol. [7800]

**CANCELLED** Shipment of World Renowned Make of High Tension Accumulators Enables Us to Sell at Prices Much Less than Wholesale; each battery contained in solid oak cabinet and fitted conveniently for carrying, all brand new, perfect, and guaranteed; the absurdly low prices are: 40 volts battery, 18/6; 50 volts, 22/6; 60 volts, 26/6; 80 volts, 32/6; why throw money away on dry batteries?—J. B. Humphreys and Co., 23, College Hill, Cannon St., London, E.C.4. [7801]

**METRO-VICK** H.T., G.B., L.T. Eliminator, £5; Lion L14 speaker, £4; Ferranti A.F.5, £1; 0.50 milliammeter, £1; E.M.1 transformer, 26/-; L.F. choke, 14/-; Philips charger, 35/-; Siam Elimeter, £1; Lewcos S.G.P. transformer, 14/-; Varley pick-up, 23/-.—Newsome, Fairhill, Styecheale Hill, Coventry. [7811]



# VOX VERITAS

## 3-CORNERED BAFFLE

Board dimen.: 30" x 30", Oak 1/2" ply.  
 Mahogany 3/4" ply.  
 Centre opening 7 1/2" diameter.

"The Wireless World," Dec. 18th, says:  
 "... a handsomely finished baffle."

This hand-polished baffle board is built with open sides and bottom which entirely eliminate box resonance. Removable top and rear leg folds flat against front.

Oak, Jacobean - 38/6  
 Mahogany, Queen Anne - 42/-

Carriage forward.

MOROGORO TRADING CORPN. LD.,  
 12, Union Court, Old Broad St., London, E.C.2.

Phone: London Wall 8236.



"The Wireless World," Jan. 1st, says:

### "... this useful accessory"

"A practical test was made on a rather unselective receiver, on which 2LO could not be tuned out at any part of the 250-600 metre waveband. With the rejector in use the interference was restricted to a small band of wavelengths between 344 metres and 367 metres only; transmissions above and below these limits being received free from interference from the Regional Station."

# REGIONAL STATION REJECTOR



- (a) Doubles the Selectivity of your set.
- (b) Fitted in 30 seconds. No alteration to your set.
- (c) Illustrated leaflet post free.

Post Free.

I.D.S. 4, Golden Square, Piccadilly Circus, London, W.1.

Telephone: Gerrard 2437.



Components, Etc., for Sale.—Contd.

**READ** This, there is bound to be something you want; all slightly used, but guaranteed to operate as new; we must clear before removal to new premises.

**TRANSFORMERS**.—Ferranti A.F.4, 10/-; A.F.3, 15/-; A.P.5, 21/-; A.P.5C, 22/6; O.P.6C, 16/-; O.P.3C, 16/-; O.P.1, 14/-; R.I. Varley general purpose, 8/-; straight line super, 15/-; Hypermu, 16/-; Pentam output, 15/-; old type, 5/-; pair B.I. Duplex push-pull, 38/-; B.I. Duplex heavy current, 27/6 type, 15/-; Formo, 5/-; Lissen, 5/-; Lissen Super, 13/-; Geophone, 9/-; Royal, 6/-; Eureka, 5/-; Telsen Ace, 5/-; B.T.H., 7/6; Brandes, 5/-; Igranite shrouded, 5/-; Marconi universal output, 15/-.

**SLOW** Motion Dials.—Ormond white face, 2/6; Burndept, 3/-; Utility, 3/-; Cleartron, 1/9; Brownie, 2/-; Igranite Patent, 2/6; others, 1/6; anti-microphonic holders, all makes, 9d. each; 2-coil holders, all makes, 1/6 each; rheostats, all makes, 9d. each; fixed condensers, all capacities to 0.05, 9d. each.

**WIRE** Wound Resistances, R.I. Varley, Dubilier, Mullard, 100,000 ohm 1/9, 250,000 ohm 2/3 each; bases, 6d.

**R.I. Varley** Permanent Crystal Detectors, 1/6; plug-in coils, all makes, half list price; also 6-pin coils and bases, ditto; Bowyer Lowe short wave chassis, with coils, H.F. choke, L.F. transformer, screens, metal panel, etc., £3.

**IGRANITE** Neutroregenerative Short Wave Kit, with 1 extra coils, short wave chokes, etc., 55/-.

**LOTUS** Relays, 10/-; Centralab 500,000 ohm resistance, 6/-; Igranite megohm ditto, 3/-; Clarostat volume control, 5/-; Royalty eliminator resistances, zero-5,000, 1,500-100,000, 10,000-700,000, 100,000-7 megohms, each 5/6; Gambrell wavemeter, with chart, 25/-; R.I. volume control, 5/-; loud-speaker units, gramophone or horn type, Lissen 5/-, Brown C.T.S. 6/-, Bullphone 7/-, other 4/-.

**LASSMAN** 4-pole Cone Unit, 10/-; Goodman P.G.3, with cone chassis, 25/-; Blue Spot 66K, 15/-; Goodman P.G.4, 20/-; Cylidon, 6/-.

**VARIABLE** Condensers.—0.0005 Geophone S.M., 7/6; Brandes, 7/6; Ormond 20/- type, 8/-; Igranite Lokvane, 6/-; Burton, 4/-; Ormond, 4/-; Formo, 3/-; others from 2/6 each; all S.L.F. or L.M.L.

**ALL** Makes 0.0003 Condensers Two-thirds Above Prices; Cylidon dual condensers, 0.0005, 5/-; J.B. twin gang condenser, 39/6 type, 20/-; Cylidon triple gang, 20/-.

**ELIMINATORS**.—A.C. Benjamin Majestic, 160 volts 60 m.a., £4; Metvick, 220 volt 60 m.a., £6; Burndept, 50 m.a., £4; direct current type, Radielle, give 220 volts 100 m.a., £4; Ecco, 10 m.a., 17/6; Climax, 20 m.a., 20/-.

**NESPER** Trickle Charger, 25/-; Burndept ditto, 25/-; Metvick elastic aerial units, 7/6; Harlie wave trap, 7/6.

**VALVES**, all guaranteed full emission.—P.M.256, 7/-; P.M.5X, 4/-; P.M.5B, 4/-; P.M.6, 5/-; P.M.6D, 5/6; Philips 505, 8/-; D.E.H.610, 5/-; P.M.26 Pentode, 14/-; H.L.610, 5/-; D.U.2, 10/-; P.X.650, 14/-; D.E.5A, 5/-; D.E.5, 2/6; D.E.5B, 2/6; L.S.5A, 10/-; S625, 8/-; Cosor S.G.210, 8/-.

**H. F. Chokes**.—R.I. Varley, 5/6; Lewcos, 5/-; Varley, 3/-; Climax, 4/-; Sovereign, 3/-; Lissen, 2/6; Success, 4/-; Weatite, 4/-; Detex, 3/-; Colvern All Wave, 5/-.

**BASEBOARD** Mounting Neutralising Aerial Condensers, Peto-Scott 2/-, Formodenser 1/6, McMichael 1/9, Igranite 2/-, Bowyer Lowe 2/-, Gambrell 2/6.

**VARIABLE** Reaction, panel mounting, Ormond, Dubilier, Peto-Scott, Magnum, 2/6; resistance capacity coupling units, R.I. Varley 7/-, Mullard 9/-, B.T.H. 5/-, Cosmos 4/-, Dubilier 4/-, Ediswan 3/-, Carborundum 3/-, Polar 2/-; Ready Radio selectivity unit, 13/-.

**CLIMAX** Mains Transformer, 20/-; Ferranti E.M.1, 100 milliamps, 27/6; Climax smoothing chokes, 7/6.

**LOUD-SPEAKERS**.—Loewe cone, mahogany cabinet, 28/-; Primax, 27/6; Brown disc, 50/-; Sterling-Mellox, 10/-; Brandes Tablecone, 50/-; Mullard cone and unit for portable, 20/-; Six-Sixty ditto, 15/-; Marconi 105 speaker, 55/-; Celestion C14, as new, £8; Webson M.C., 55/-; Marconi 6-volt chassis, £3.

**SETS**.—McMichael All Mains Screened Dimic Three, 200-240 volts, £19/10; Burndept 1929 model Screened Grid Four, £17/10, as new; R.I. Varley, 4 valves, in mahogany cabinet, with folding doors, with valves, £6; Marconi 4-valve type 42, £6, in mahogany cabinet, with doors; Mullard Portable, less valves and H.T. battery, £7/10; Burndept Super-het Ethodyne, H.T. battery, cabinet damaged at back, but otherwise perfect, with 2 frame aerials, £6; Burndept 2-valve, in mahogany cabinet, wonderful results on loud-speaker, with valves, £3; General Radio 2-valve, new, £2; Marconi V2 long range, 20/-; etc.

**WATMEL** Pick-up Arm, 4/-; Kusha balanced ditto, 7/6; Ferranti portable meter, 7.5v., 150v., 30 m.a., 32/6; another, but only 15 m.a., 27/6; Weston Piujack voltmeter, 30/-.

**ALL** Above Items Postage Extra or Carriage Forward; sent c.o.d. if required; no part exchange.

**SCIENTIFIC DEVELOPMENT** Co., 51, Fishergate, Preston. Tel.: 1364. [7778]

## WATTS AN OHM WITHOUT A DIX-ONEMETER

50 Electrical Instruments in 1  
AMPS VOLTS OHMS

Only Six Terminals, but what Ranges!

The DIX-ONEMETER is portable size to go in the pocket, but big enough to cover the whole range of D.C. electrical measurements. You can have multipliers to work from 50 micro-amps to 150 amps and 20 milli-volts to 2,000 volts. What other instrument to Brit. Elec. Standard Asscn. Standard of Accuracy for First Grade meters is available at the price? None! A novice can use it as accurately as an expert. No switch to be accidentally turned with disastrous results, as each range has its independent multiplier and a safety button controls the moving coil.

## PRICE REDUCTION OF THE MULTI-RANGE DIX-ONEMETER

Dix-onemeter 50/- ONLY  
Range Multipliers 6/6 each

Electrical and Radio Test Booklet Free

The extensive sale and increased use has enabled a reduced price to be offered below the already exceptionally low price.

DIX-ONEMETERS are now 50/- only, a remarkably small price for a meter worth £10 in comparison with others.

Latest Model. To 1st Grade Brit. Eng. Standard Mirror Double Scale. Moulded Base. The finest Precision Multi-measuring instrument is the DIX-ONEMETER, the acknowledged Radio standard beloved by Expert and Amateur.

**ELECTRADIX RADIOS**  
Apparatus Depot

218, Upper Thames Street, E.C.4.  
City 0191.

## BERCLIF COILS

1930 EVERYMAN 57/- the Set.  
NEW KILO-MAG 50/-  
RECORD III 50/-

CABINETS AND DIALS.

**SIMMONDS BROS.,**  
SHIRELAND ROAD SMETHWICK

**"It may  
interest you  
to know**

that my advertisement in 'The Wireless World' brought over 70 replies in three days, which is, I think, a wonderful testimony to the advertising efficiency of your paper."

J. MITCHELL,

10, Hilton Avenue, Frizinghall,  
Bradford, Yorks.

Full particulars of advertising in the Classified Columns of "The Wireless World" are given on the first page of Miscellaneous Advertisements.

W.W.76.

## Components, Etc., for Sale.—Contd.

WESTON Moving Coil Relay; 30/-, or offer; unused, exchange for Brown microphone amplifier.—Coffey, Daisyhill, Rawdon. [7777]

A.F.S.C. 20/-; A.F.5, 20/-; 0-100 Weston milliammeter, 20/-; 3 P625A valves, 22/6; Philips pick-up, 30/-; all as new.—Murray, Coldstream. [7770]

L.F. Transformers, Lissen, 5/6; Success, 7/-; Lissenola unit, 8/-; mains winding for moving coil speaker, 18/-.—Pritchard, Granville Gardens, Ealing, W.5. [7759]

FERRANTI A.F.50 Transformer, Metro Vic A.C., S.G. valve, indirectly heated, for use with adaptor, Brown pick-up, with Kusette arm; lot £2/10, or 15/-, 12/-, and 23/-.—C. O. Pattison, 548, Shields Rd., Newcastle-on-Tyne. [7760]

COMPONENTS for 3-valve Set, dual wave, choke output, and 3 valves; £2/10.—Box 4361, c/o The Wireless World. [7768]

METER Suprecision 3, 12, 120 mA., 1.2, 6 amp., 6, 24, 120, 480 volts, 30/-; also 6-volt moving coil speaker, £2.—71, Burbage Rd., Herne Hill, S.E. [7812]

R1 Hypermu Transformer, 12/6; Celestion Woodruff pick-up, 30/-; Lewcos 75X, 200X coils, 2/6 each; all guaranteed new.—Box 4369, c/o The Wireless World. [7813]

PRIVATE Sale Like New Goods.—Sets, no cabinet, 3-valve 25/-, 2-valve 20/-; pick-ups, Blue Spot, G.E. Co., 17/6; B.T.H. C2 speaker, 25/-; Brown's V unit, chassis cone, 27/6; double microphone amplifier, £3, cost £20; meters, coils, transformers, H.F. chokes, condensers, leaks, resistances, switches, etc.; send requirements; call evenings.—78, Lavender Sweep, S.W.11. [7804]

30/12/29.—Dear Sirs, I must say how pleased I am with your prompt attention to my order and the satisfaction of the part exchange; I had tried several other firms before writing to you to see what they would give me for my surplus parts, but every time was disgusted with their offers; I shall be pleased to get any further radio components from you when next requiring same. The above is genuine and unsolicited; we receive many of a similar nature. Why?—Bostock and Stonnill, 1, Westbourne Terrace, Park Rd., London, S.E. 23. [7799]

EKCO D.C. All-mains Units, hardly used, £3; A.F.5, 20/-; P.M.2, 9/6; pair Orgola coils, new, 11/6; Goltone D.C. eliminator, 15/-; Cosmos A.C. S.G., 18/6; large assortments of high class condensers, coils, valves, transformers, chokes, resistances, etc., both used and new, to be cleared; send for lists.—Heaton, 42, Green Lane, Thornton Heath, Surrey. [7796]

MULLARD H.T. Unit, new, £4; O.P. 3C, 10/6; Utility 3-pole, 4/6; Mullard 100,000 resistance, 5/-; headphones, 5/-; Brookmans rejector, 8/-; D.E.P. 7/6; S.S. 210, 5/-; 220 P, 7/6.—Lodge, Crookhill Hall, Conisbrough, Rotherham. [7794]

CONTROL your Receiver from that Other Room by Means of the Foolproof and Inexpensive Yarg Relay, no maintenance or attention; model for battery operated sets, 10/6 post free; mains models, 17/6, 22/6, 25/-; stamp particulars.—Yarg, 1, Eccles Old Rd., Manchester. [7790]

BANKRUPT Stock, guaranteed.—Dubilier R.C. units, 5/6; transformers, Telsen Radiogrand, 9/-; Varley Nicore I, 12/6; Nicore II, 7/6; R.I. Hypermu, 15/-; Ready Radio selectivity units, 15/-; B.T.H. phones, 12/6; cash with order or c.o.d.; satisfaction or money returned.—Sencer, Sheep St., Northampton. [7776]

BLUE Spot 66K Unit, as new, 17/6; Blue Spot chassis, 8/6; B.S.A. Kone, 35/-; Edison-Bell pick-up, 12/6; Mullard's new P.M. 24 pentode, 17/6.—13, Hawkesley Mill Lane, Northfield, Birmingham. [7791]

APPLEBY'S Bargains.

END of Year Clearing.—The following slightly used material is offered subject to sale; every article will be severely tested before despatch, and guaranteed in workable condition; the following items quoted are net cash and carriage paid in Great Britain (except condensers as below):—

END of Year Clearing.—L.F. transformers: Ferranti A.F.5, as new 25/9 each, second grade 21/9 each, limited number; Ferranti A.F.3, as new, 19/- each, second grade 15/9, limited number; Ferranti A.F.4, 12/6 each; Marconi Ideal, 2.7 to 1, 17/- each; other ratios, 15/9 each, limited number; small Ideal Marconi, 9/6 each; R.I. straight line transformers, 15/- each; Climax L.F.A., 13/9; Mullard Permacore, as new, 19/- each, second grade 15/9, limited number; likewise Phillips, 19/- and 15/9 each; Marconi Popular, 8/6; G.E.C. Pye and B.T.H., 9/- each; Telsen Grand, 7/6; R.I. Hypermu, 17/6, as new, limited number; more next week!

END of Year Clearing.—Variable condensers: Ormond No. 3 S.L.F. and Log, 0.005 and 0.00035, 3/9 each, as new; second grade, 3/- each; friction control model, 7/6 each, as new; in lots of two or more post paid; singles, postage 6d. extra; more next week!

APPLEBY'S, Number Forty-four, Chapel St., Marylebone, N.W.1 (four minutes from Oxford St., London). [0316]

## How to sell a Portable!

For the sale or purchase of Portable or other Receivers use the Miscellaneous Columns of "The Wireless World." A recent advertiser writes as follows:

"I am very satisfied with the results obtained. The Portable set was sold the same day, and I had over twenty other replies, including prepaid Telegrams. I also had a large number of callers, and altogether am very pleased with the pulling powers of your valuable paper."

M. A. FROST,  
54, Clerkenwell Road,  
London, E.C.1.

W.W. 85

## Wonderful Response!

A recent advertiser in "The Wireless World" writes:—

"I should like to inform you of the wonderful response to my advertisement in 'The Wireless World.' I have received no less than 20 applications for the Ferranti and Marconi Transformers and most of the other goods have been sold."

W. H. Trevett,  
80, High Street,  
Erith, Kent.

W.W.82.

Mention of "The Wireless World," when writing to advertisers, will ensure prompt attention.



MISCELLANEOUS.

ALEXANDER BLACK.

PLEASE Note New Address.

THE Original Wireless Doctor, will call (London and Home Counties) and cure your set.

CONSULTATIONS by Appointment Without Obligation, sets installed, maintained, and brought up to date, gramophone pick-ups, eliminators, and Webson moving coil speakers demonstrated; purity reproduction specialist.

55 Ebury St., Victoria, S.W.1. Sloane 1655. [0277]

EASY Payments.—We supply, by easy payments, components, accessories, and sets, any make; 10% down, balance spread over 10 months.—Send list of requirements to London Radio Supply Co., 11, Oat Lane, London, E.C.2. [0097]

WIRELESS Notes.—A monthly service of information for all those who want the very best in wireless or gramophone reproduction; frank criticism of receivers and components; immediate postal help and advice in all difficulties; something new and unique; you must have it if you want to know the truth.—Full particulars free from Ernest H. Robinson, Langmead, Pirbright, Woking, Surrey. [7607]

SCOTT SESSIONS and Co., Great Britain's radio doctors, officially approved as wireless repairs by Radio Society of Great Britain and Wireless League; old sets of every type repaired, rebuilt, modernised; send set for immediate quotation.

SCOTT SESSIONS and Co.—New sets constructed with your or our components, guaranteed finest workmanship; we specialise in "The Wireless World" circuits; remember, we have satisfied customers throughout the British Isles and in three Continents; if you so desire, we will design and construct high grade apparatus to suit your special circumstances for quality, range and selectivity.—Tel.: Tudor 5326. Muswell Hill, London, N.10. [0262]

ENGINEERS.—Can't we get together? All we ask is the chance to prove that you can earn £300, £400, £500 per year and more. Other men are doing it, and you can do the same. We have an unrivalled and world-wide organisation waiting to help you, whether you be novice or expert. If you wish for something more than a bread-and-butter job you owe it to yourself to investigate our service. Our handbook, "Engineering Opportunities," has pointed the way to better things to over 20,000 of your fellows. It contains details of A.M.I.Mech.E., A.M.I.C.E., A.M.I.E.E., A.M.I.A.E., A.M.I.Struct.E., C. & G., G.P.O., etc., exams, and outlines home study courses in all branches of Electrical, Mechanical, Motor, and Wireless Engineering. In a brilliant article Professor A. M. Low shows clearly the chances you are missing. The book and our advice are quite free. We guarantee No Pass—No Fee. Don't miss this opportunity; send a postcard—now (state branch, post or exam.)—British Institute of Engineering Technology, 87, Shakespeare House, 29, Oxford St., London, W.1. [7640]

PATENT AGENTS.

PATENTS and Trade Marks, British and foreign.—Gee and Co. (H. T. P. Gee, Member R.S.G.B. and A.M.I.R.E.), 51-52, Chancery Lane, London, W.C.2. 'Phone: Holborn 1525. [0001]

KING'S PATENT AGENCY, Ltd., 146a, Queen Victoria St., E.C.4.—Free advice and handbook on patenting inventions and registering trade marks by registered agent with 43 years' experience. [0002]

PATENTS.

THE Proprietor of Patents Nos. 262752 and 263753, Variable Directional Electric Wave Generating Device and Directive Projecting and Receiving System for use in Wireless Telegraphy or Telephony, is desirous of entering into arrangements by way of licence or otherwise on reasonable terms for the purpose of exploiting the same and ensuring its full development and practical working in this country. All communications should be addressed in the first instance to J. E. Evans-Jackson and Company, Registered Patent Agents, Bath House, 57 to 60, Holborn Viaduct, London, E.C.1, and 34, Dame Street, Dublin, Ireland. [7712]

PATENTS and Designs Acts, 1907 to 1928.

NOTICE is hereby given that The Mullard Radio Valve Co. Ltd., of 45, Nightingale Lane, Balham, London, S.W.12, seek leave to amend the Specification of Letters Patent No. 287,958 granted to Harold Wade for an invention entitled "Improvements in or relating to circuit arrangements and discharge tubes for amplifying electric oscillations." Particulars of the proposed amendments were set forth in No. 2136 of the Illustrated Official Journal (Patents), published on the 27th December, 1928. Any person, or persons, may give Notice of Opposition to the amendment by leaving Patents Form No. 19 at the Patent Office, 25, Southampton Buildings, London, W.C.2, within one calendar month from the date of publication of the said Journal.—W. S. Jarratt, Comptroller-General. [7826]

TO Manufacturers.—Loud-speaker patent for sale.—Box 4372, c/o The Wireless World. [7816]

POPULAR

The Brownie POPULAR Transformer is every bit as good as it looks. Its purity of amplification gives vivid clarity throughout the full musical range, while its sturdy British construction ensures that it will give this quality of reproduction not just now and then, but always. It costs only 9/6, and does the work of transformers at double its price.

BROWNIE WIRELESS CO. (G.B.) LTD.  
Nelson Street Works, London, N.W.1



BROWNIE WIRELESS

CLIX

21 VARIETIES for every form of contact

<p>No. 15</p>	<p>No. 15. ALL-IN PLUG AND SOCKET.</p> <p>Wherever a terminal of any sort is required, the Clix Plug and Socket can be utilised. It is entirely insulated as well as when connected or disconnected. Price complete 8d. Flex Portion 4d. Panel Portion 4d. Both Portions engraved.</p>	<p>No. 3</p>
<p>No. 4</p>	<p>No. 3. 'FIT-ALL' SPADE TERMINAL. 2d.</p> <p>No. 10. CLIX-LOX WANDER PLUG. 2 1/2d.</p> <p>No. 4. HOOK TERMINAL. 2d.</p> <p>No. 10</p> <p>Supplied with engraved insulators. Full range of markings 1/2d. extra. Write for the Clix Folder.</p>	<p>No. 10</p>

LECTRO LINX LTD. 254, Vauxhall Bridge Road, S.W.1

REPAIRS.

TWELVE Months' Guarantee Accompanies all our Repairs; any make of L.F. transformer, headphones, or loud-speaker repaired and despatched within 48 hours; 4/- post free; don't discard if burnt out; terms to trade.—Transformer Repair Co., (Dept. W.), 214, High St., Colliers Wood, S.W.19. [0011]

SCOTT SESSIONS and Co., Great Britain's radio doctors; read advertisement under Miscellaneous column. [0263]

REPAIRS Returned Post Free, and to ensure satisfaction send remittance after appraisal of same.—Leeds Wireless Repair Service.

LOUD-SPEAKERS, headphones, rewound to any resistance and remagnetised, 3/-; transformers rewound, 4/-; Blue Spots, Triotrons and 4-pole units, 4/6; work guaranteed.—Leeds Wireless Repair Service, 5, Boston Place, Green Rd., Leeds. [7652]

GUARANTEED Repairs by Experts; loud-speakers, headphones, cone units, pick-ups, any type, re-wound, remagnetised and adjusted; post free, 4/-; transformers from 4/-.—Howell, 91, Morley Hill, Enfield, Middlesex. [7795]

WANTED.

MARCONIPHONE Moving Coil Cabinet, oak or mahogany.—Phillips, 6, Cheapside, Spennymoor, Co. Durham. [7758]

WANTED, D.E.L. and D.E.P. 610; would exchange for P 625 and Mazda B 11.—Hoare, Brownlow, Hindhead. [7775]

GOOD Portable, full particulars.—X. P. Z., Smith's Bookstall, Warrior Square, St. Leonards, Sussex. [7820]

WANTED, two 2-volt Mullard S.G. valves, 50,000 and 10,000 ohms resistances, iron core H.F. choke, air core ditto, 3 0.01 and 3 0.001 condensers, 2 Coscor 250 X.P. valves, matched if possible, push-pull transformer, 1 Clarostat, Midget 0.0005 Ormond log, also Ormond drum dials; for sale. National portable, as new, £7/10; new H.T. battery.—Box 4378, c/o The Wireless World. [7829]

MARCONI Ideal, 2.7-1, heavy duty H.T. eliminator chokes, new pattern Tonatuna, variable 0.00025 transmitting condensers. P.625.—Particulars to Box 4370, c/o The Wireless World. [7814]

BUSINESSES & PROPERTY FOR SALE, TO BE LET, OR WANTED.

OLD Established Radio Business, with large shop and living accommodation, in main road; stock, workshop, plant, etc., well connected, excellent opportunity.—Box 4375, c/o The Wireless World. [7819]

EXCHANGE.

YOUR Old Apparatus Taken in Part Payment for Latest Type; see our advert in column Receivers for Sale.—Scientific Development Co., 51, Fishergate, Preston. [0230]

BRAND New Goodman Moving Coil Speaker; exchange for 3-valve set or good parts.—C. Jackson, 53, Lavender Sweep, Clapham Junction. [7825]

SITUATIONS VACANT.

SITUATIONS Guaranteed as Wireless Operators, age 15-30, day-evening postal courses; boarding students' fee payable after situation found.—School, 321, Mansfield Rd., Nottingham. [7746]

DRAUGHTSMAN for Radio Components and Sets, good, capable designer to take charge of section.—Full details of experience, age and salary to Box 616, Sells, Fleet St., E.C.4. [7803]

BOOKS, INSTRUCTION, ETC.

WET H.T. Batteries are now a proved success; write for new illustrated booklet, giving cost and method of building and maintaining free; mention paper.—Taylor, 57, Stuyley Rd., Stockwell, London. [0077]

STEP by Step Wireless; a complete course of the theory of electricity in relation to the practical design of wireless apparatus, eliminators, circuits, etc., with extracts from a designer's notebook, giving up-to-date practical application; issued weekly; send 1/- p.o. for first 4 weeks.—Clifford Pressland, A.M.I.E.E. Inc., Dept. W.W., Hampton-on-Thames. [0195]

FREE: Inventor's Guide on Patents.—T. A. A., 253 (W), Gray's Inn Rd., London, W.C.1. [6373]

LOUD-SPEAKERS, by C. M. R. Balbi.—A practical hand book for wireless amateurs on the selection, construction and performance of loud-speakers, with notes on the detection and remedying of faults; 3/6 net, of bookellers or Pitman's, Parker St., Kingsway, London, W.C.2. [7069]

Advertisements for "The Wireless World" are only accepted from firms we believe to be thoroughly reliable.

**INDEX TO ADVERTISEMENTS.**

	PAGE		PAGE		PAGE
Accumulators Elite	22	Garnett, Whiteley & Co., Ltd.	4	Premier Supply Stores	24
Adolph, Fredk.	19	General Electric Co., Ltd.	Cover iv.	Radiogramophone Development Co.	13
Appleyby, E. Hetherington	19	Glasscoe, R. H., & Co.	19 & 23	Rigby & Woodhendon	24
B. & J. Wireless Co.	19	Grosvenor Battery Co., Ltd.	6	Rothermel Corporation, Ltd. (Centralab)	14
Baker's "Selhurst" Radio	20	H. & B. Radio Co.	23	Rowley, Thomas A., Ltd.	14
Bayliss, Wm., Ltd.	6 & 28	Haw & Co., Ltd.	20	Sheffield Magnet Co.	7
Belling & Lee, Ltd.	20 & 22	Holzman, L.	Cover i.	Simmonds Bros.	26
British Ebonite Co., Ltd.	18	Hughes, F. A., & Co., Ltd.	12	Telegraph Condenser Co., Ltd.	13
British General Manufacturing Co., Ltd.	18	I.D.S.	25	Telsen Electric Co., Ltd.	Cover i. & 20
British Institute of Eng. Tech.	18	Igranic Electric Co., Ltd.	15	Thomas, Bertram	8
British Insulated Cables, Ltd.	Cover iii.	Jackson Bros.	8	Transformer Repair Co.	24
Brownie Wireless Co. (G.B.), Ltd.	27	Leetro Linx, Ltd.	27	Trelleborg Ebonite Works, Ltd.	28
Burton, C. F. & H.	Cover i.	Lisenin Wireless Co.	2	Tudor Accumulator Co., Ltd.	2
Carrington Mfg. Co., Ltd.	14	Lock, W. & T. Ltd.	20	Tulsemere Manf. Co.	23
Climax Radio Electric, Ltd.	21	Lyons, Claude, Ltd.	Cover i. & 19	Vandervell, C. A., & Co., Ltd.	5
Competition	11 & 12	Marconiphone Co., Ltd.	17	Varley (Oliver Pell Control), Ltd.	5
Cossor, A. C., Ltd.	16	McMichael, L., Ltd.	Cover ii.	Ward & Goldstone, Ltd.	28
Dubilier Condenser Co. (1925), Ltd.	4 & 14	M-L Magneto Synd., Ltd.	18	Westinghouse Brake & Saxby Signal Co., Ltd.	Cover iii.
Eastick, J. J., & Sons	24	Merogoro Trading Corp., Ltd.	25	Weston Electrical Instrument Co., Ltd.	18
Eaton, S., & Sons	20	Mullard Wireless Service Co., Ltd.	1	Whiteley, Bonelham & Co., Ltd.	15
Electradix Radios	26	Osborn, Chas. A.	23	Wilkins & Wright, Ltd.	2
Ever Ready Co. (G.B.), Ltd.	9	Paroussi, E.	24	Wingrove & Rogers, Ltd.	15
Ferranti, Ltd.	3	Perseus Radio Manf. Co.	22	Wolverhampton Die Casting Co.	2
Forno Co.	14	Pertrix, Ltd.	12		

**BE SURE OF YOUR PANEL**

**EBONITE IS GENUINE**



**BECOL**

Tested to 104,000 volts.  
USE THE PRIZE WINNING  
LOW LOSS FORMER.

LOOK FOR TRADE MARK.

Write for Handbook on Windings and Circuits, Post Free 4d.  
THE BRITISH EBONITE CO., LTD., HANWELL, LONDON, W.7.

**"GOLSTONE" 3-RANGE RADIO METER**

Reading 0-6 volts, 0-150 volts, 0-30 milli-amperes. The purpose of the milliamp. scale is to enable a correct reading of the current taken from the H.T. Battery. Also if there be distortion, this will be disclosed by the vibration of the needle when the instrument is connected into the extra H.T. positive lead.

No. R30/145  
**PRICE 8/6 EACH**

From all First Class Radio Dealers—Refuse Substitutes, if any difficulty, write direct.  
For full range of RADIO METERS see Catalogue R/121, sent FREE on request.



**Ward & Goldstone**  
PENLETON MANCHESTER

**Superior A.C. POWER TRANSFORMERS and CHOKES for the MAINS**

from  
**35/-**  
for all  
Inputs  
and  
Outputs

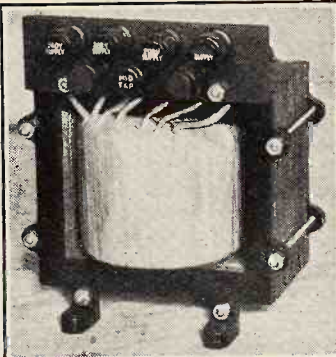

*Special Audio-Frequency Chokes and Transformers, and Smoothing Chokes for all purposes.*

**WILLIAM BAYLISS LTD.,** Sheepcote Street,  
Telephone: Mid. 1409.      Telegrams: "Drawbench, B'ham."  
**BIRMINGHAM.**

Superfine Quality  
**Trelleborgs**  
GUARANTEED  
FINE EBONITE

**25% REDUCTION ON RETAIL PRICES**

THE BEST PANELS—NOW THE CHEAPEST.

Trelleborg Ebonite Works, Ltd.,  
Union Place, Wells Street, London, W.7

Highly Polished 3/16" Black or Wavy, 9/16d. sq. in. 6x9, 2/8; 7x14, 4/8; 7x18, 6/-; 7x21, 7/-; 8x12, 4/8; 8x16, 6/-. Highly Polished, 3/16" Mahogany, 1/2" Black or Wavy, 1/4d. sq. in. 6x9, 3/8; 7x14, 8/3; 7x18, 8/-; 7x21, 9/3; 8x12, 8/-; 8x16, 8/-; Highly Polished, 1/2" Mahogany, 1d. sq. in. 6x9, 4/8; 7x14, 8/2; 7x18, 10/6; 7x21, 12/3; 8x12, 8/-; 8x16, 10/8.

**EXPERIMENTAL WIRELESS** W.W.2  
& The WIRELESS ENGINEER

**The Journal for Professional Engineers and Advanced Wireless Experimenters**

Monthly 2/6 net.      Annual Subscription 32/- post free.

ILIFFE & SONS LTD., Dorset House, Tudor Street, London, E.C.4.

Mention of "The Wireless World," when writing to advertisers, will ensure prompt attention.

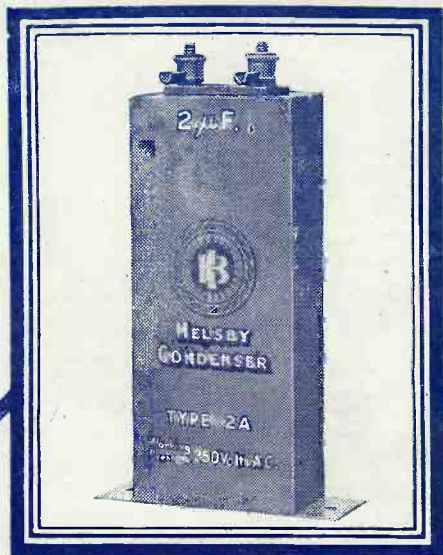

## FOR ELIMINATOR CIRCUITS

You cannot afford to use any but the best Condenser in an eliminator circuit.

### HELSEBY CONDENSERS

are made and guaranteed by a firm with 30 years' experience in condenser making, from small telephone and radio condensers to Power Condensers weighing upwards of 2 tons.

Guaranteed working voltages :-

Type M	-	-	150 volts D.C.
Type 2A	-	-	350 volts D.C.
Type 3A	-	-	450 volts D.C.
Type 4A	-	-	600 volts D.C.

All Helsby Condensers are vacuum dried and impregnated with a special non-hygroscopic material which renders them moisture proof.

If unobtainable from your dealer, write to us giving his name and address.



## BRITISH INSULATED CABLES LTD

PRESCOT - LANCS.

Makers of PRESCOT and HELSEBY cables



THE



## METAL RECTIFIER STYLE H.T.4 PRICE 37/6

D.C. output 180 volts 30 m.a. full wave, when used in the "Voltage Doubler" circuit.

Full details of this and other A.C. mains unit circuits are given in our 32-page book, "The All-Metal Way, 1930."

Send 2d. Stamp for a Copy.

The Westinghouse Brake & Saxby Signal Co., Ltd.,  
82, York Rd., King's Cross, London, N.1

EVERYTHING **The G.E.C.** ELECTRICAL  
*your guarantee*

# RADIO WEEK



## Go home and listen with

# Osram Valves

One of the famous  
**OSRAM**  
**SUPER-POWER**  
**VALVES**  
 will make  
 the programmes  
 louder, clearer and  
 more life-like.

**MADE IN ENGLAND**

Sold by all  
Wireless Dealers

with the

## "TENACIOUS COATING"

Advt of The General Electric Co., Ltd., Magnet House, Kingsway, London, W.C.2.

Printed for the Publishers, ILLIFFE & SONS LTD., Dorset House, Tudor Street, London, E.C.4, by The Cornwall Press Ltd., Paris Garden, Stamford Street, London, S.E.1.

Colonial and Foreign Agents:  
 UNITED STATES—The International News Co., 131, Varick Street, New York. FRANCE—W. H. Smith & Son, 248, Rue Rivoli, Paris; Hachette et Cie, Rue Réaumur, Paris.  
 BELGIUM—W. H. Smith & Son, 78, Marche aux Herbes, Brussels. INDIA—A. H. Wheeler & Co., Bombay, Aljabad and Calcutta. SOUTH AFRICA—Central News Agency, Ltd.  
 AUSTRALIA—Gordon & Gotch, Ltd., Melbourne (Victoria), Sydney (N.S.W.), Brisbane (Queensland), Adelaide (S.A.), Perth (W.A.), and Launceston (Tasmania).  
 CANADA—The American News Co., Ltd., Toronto, Winnipeg, Vancouver, Montreal, Ottawa, St. John, Halifax, Hamilton; Gordon & Gotch, Ltd., Toronto; Imperial News Co. Toronto, Montreal, Winnipeg, Vancouver, Victoria. NEW ZEALAND—Gordon & Gotch, Ltd., Wellington, Auckland, Christchurch and Dunedin.

# The Wireless World

4<sup>D</sup>

AND  
RADIO REVIEW

*The Paper for Every Wireless Amateur*

Wednesday, January 15th, 1930.

**NO MORE BATTERIES  
WITH YOUR  
PORTABLE  
SET**

*Run it off your  
Mains with an*



**"EKCO" H.T. UNIT**  
FOR D.C. or A.C. Mains

Write for Free Booklet on "All-Electric Radio" to:  
E. K. Cole, Ltd., Dept. W, "EKCO" Works, Leigh-on-Sea.



**NEEDS  
TONE  
VOLUME  
DISTANCE  
PUT NEW LIFE  
INTO YOUR RECEIVER**

**Mullard**  
THE MASTER VALVE



AWARDED THE CERTIFICATE OF  
THE INSTITUTE OF HYGIENE  
FOR QUALITY AND PURITY



Superfine Quality

## Trelleborgs

GUARANTEED  
FINE EBONITE

**25% REDUCTION ON RETAIL PRICES**

120000 VOLTS PER M/M  
National Physical Lab Report

TRELLEBORG EBONITE WORKS, LTD.,  
Union Place, Wells Street, W.1



There  
is  
nothing  
better

# EXACTNESS THAT COUNTS...



Supreme precision in construction allied with outstanding genius makes McMichael Receivers without equal for results achieved. Such perfection results in ideal selectivity, enabling the maximum number of stations to be obtained without interference, and with greater volume than usual.

## The McMICHAEL SUPER RANGE PORTABLE FOUR

Incorporating the latest Screened Grid Amplification—unsurpassed for power and high quality of tone. The most effective Receiver indoors or outdoors. Fitted in a beautifully finished furniture hide suit case with patent locking clips. Easy to tune—single dial. Exceptional volume and selectivity. Gives a wonderfully true reproduction of every note broadcasted. Superlative tonal quality. Low cost of upkeep. Special volume control.

CASH PRICE

**22** GNS.

(Including all Equipment and Royalties).  
or by our special "Deferred Payments on Hire Purchase Terms" system, £5 down and 10 monthly payments of £2:1:0.

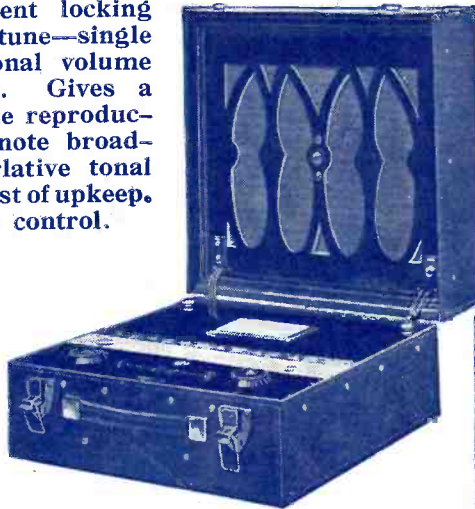

Owing to the high degree of selectivity in this, and our other Screened Grid Portable Receivers, we are able to guarantee complete selectivity between all main B.B.C. stations under the new scheme of wavelengths.

*The ideal combination of the latest valves and the most advanced circuit for portable and self-contained receivers—hear the McMichael Super Range Four (either model) demonstrated at any high-class radio store, or call at our London Showrooms.*

### L.M<sup>©</sup> MICHAEL LTD

Manufacturers of Wireless and Scientific Apparatus  
**WEXHAM ROAD, SLOUGH, BUCKS.**

Telephone: SLOUGH 441-442. Telegrams: RADIETHER, SLOUGH.  
London Showrooms: 179, STRAND, W.C.2, (Telephone: Holborn 2466.)

## The McMICHAEL SUPER RANGE FOUR (Table Model)

Containing a circuit of exactly similar design to that of the Portable Model, but fitted in a handsome Walnut Cabinet, mounted on a turntable. Designed with a self-contained frame aerial, this receiver is intended for use in the home where an outdoor aerial and earth are not necessary or desirable. An additional aerial and earth can be used to add to the normal and very remarkable range.

CASH PRICE

**26** GNS.

(Including all Equipment and Royalties.)



Mention of "The Wireless World," when writing to advertisers, will ensure prompt attention.

# A1 RADIO

## TELSEN TRANSFORMERS

**THE TRANSFORMER  
THAT PUT A1 IN RADIO**

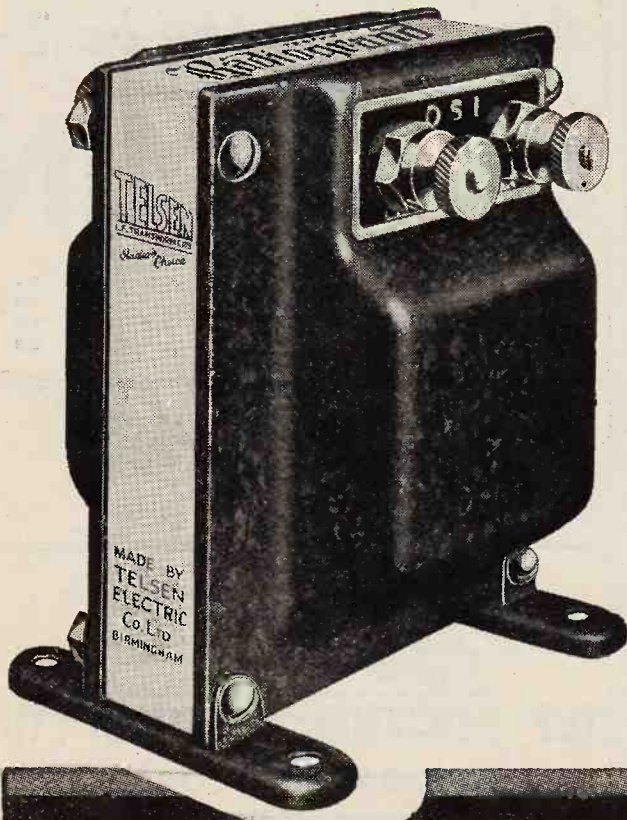

Telsens Transformers have set a standard of performance second to none in the history of Radio Component manufacture. They give equal rendering of the Treble and Bass notes and have been accepted as standard by many of the leading Set Manufacturers. Fit one in your set—notice the perfect rendering of all notes throughout the entire musical range; you will then appreciate Wireless in all its glory.

Radiogrand 12/6    Ace    8/6  
Ratios 3-1 & 5-1.    Ratios 3-1 & 5-1.

**TELSEN ELECTRIC CO. LTD.**  
Miller Street, Birmingham.

**THE NEW  
CELESTION  
LOUD SPEAKER  
MODEL Z.20**

PERCY HARRIS, a foremost radio expert, writes in the "Wireless Constructor"—"Z20, renowned for brilliancy and quality . . . speech and music particularly good . . . a handsome instrument."

Gloriously realistic in tone . . . holding undisputed rank as the finest of all loud speakers

*Model Z.20 is designed specifically to give the finest possible results with any set from a Two-Valve to a Power Amplifier. Crowned with the Celestion hall-mark—a beautifully designed and hand-polished cabinet.*

In Oak . . . . . £7 . 15 . 0.  
Mahogany . . . . . £8 . 5 . 0.  
Walnut (to-order) . . . £9 . 0 . 0.  
Other Celestion models from £3.15.0.

**CELESTION**

*The Very Soul of Music*

WRITE FOR AN ABSORBING FREE BOOK ON "SOUND RE-CREATION"

London Showrooms:  
106, Victoria Street, S.W.1

Write to: Celestion Ltd.,  
Dept. C  
Kingston-on-Thames

110



**Certainly-  
experiment  
with your set**

**BUT NOT WITH  
the COMPONENTS**

*Always use the best—*

**BENJAMIN**

**VALVEHOLDERS.**



Clearer Tone . . . . .	2/-
Vibroder . . . . .	1/6
5-Pin Holder . . . . .	1/9
Pentode . . . . .	2/3

**SWITCHES.**

Push-Pull . . . . .	1/3
Rotary . . . . .	1/9



**TURNTABLE.**



Ball-bearing and equipped with hinged and folding legs . . . 7/6

Send P.C. for fully illustrated leaflet No. 2003.

**THE BENJAMIN ELECTRIC LTD.**  
**BRANTWOOD WORKS, LONDON, N.17**



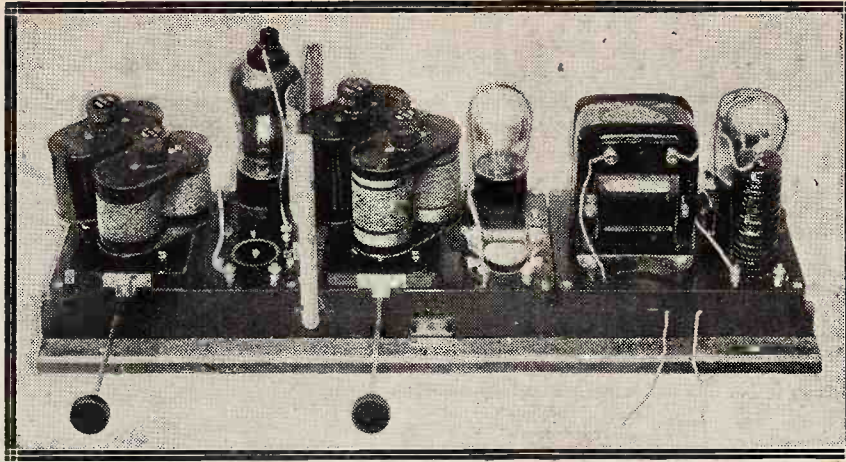

# An "all-mains" receiver constructed in 15 MINUTES !

**WITH THE LEWCOS  
3 VALVE KIT**

Eliminating troublesome complications, the Lewcos 3 Valve Kit, designed for use with either D.C. or A.C. valves, enables a safe and satisfactory all-mains receiver to be built in fifteen minutes. Highly satisfactory results of quality and strength, combined with selectivity and sensitivity, are provided by this receiver.

**SEND TO-DAY FOR BOOKLET R.58.**

This free booklet fully describes the construction, assembly, working and performance of one of the most efficient circuits ever conceived.

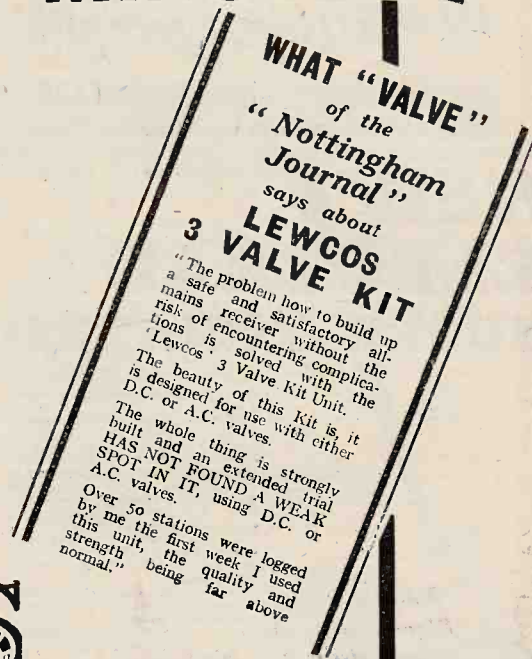

# LEWCOS

REGD.

# 3 VALVE KIT

**THE LONDON ELECTRIC WIRE COMPANY AND SMITHS LIMITED**  
Church Road    Leyton    London, E.10

Trade Counter : 7 Playhouse Yard, Golden Lane, London, E.C.1

# Use a **NON-SPILLABLE** battery in your home ~

It is so fatally easy for a few drops of acid to spill when changing over ordinary low tension accumulators. You may already have experienced the vexation of discovering damage to carpet or furniture on which acid has dropped.

The C.A.V. Non-spillable accumulator contains acid—but in a jellied form. You cannot spill it, and it does not flow, so you can use it in any position.

Because of its advantages over the free-acid type of non-spillable accumulator, its compactness, its safeness, it is the ideal battery for portable receivers. It is also the battery to relieve you of all anxiety. Why not use one with your home receiver?

Our latest Radio Battery catalogue No. T3 will gladly be forwarded upon application.

We have recently introduced an entirely new range of rechargeable high tension accumulators—built like car batteries. May we send you details?

**CAVandervell & Co., Ltd.**  
ACTON, LONDON, W. 3.



IF ANY OF YOUR FRIENDS  
DO NOT POSSESS WIRELESS  
—INVITE THEM TO LISTEN  
TO YOUR SET DURING RADIO  
WEEK—JAN. 12th TO 13th.

*All Position-Non Spillable Batteries*



*The Original Jelly Acid Battery Perfect for Portables*

## NEW / ELECTRAD SUPER-TONATROLS

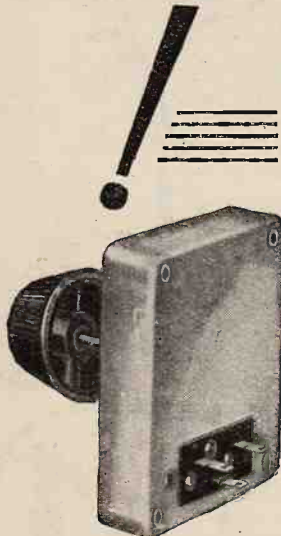

These new Electrad variable non inductive high resistances will safely dissipate 5 watts at any position of the contact, with one-tenth or more of the resistance element in circuit. The all-metal construction with the graphite resistance element fused to an enamel base obviates the necessity of using either a low current paper element or fine wire. The action is amazingly smooth, long lived and both mechanically and electrically perfect.

The Super-Tonatrol embodies new ideas of proved merit with generous factors of safety which more than fulfil all expectations.

Super-Tonatrols are made in seven resistance ranges, taking care of all possible requirements.

	List Price, each
No. 1 A, 25,000-ohm potentiometer	12/6
" 2 A, 10,000-ohm potentiometer	12/6
" 3 A, 50,000-ohm rheostat	12/6
" 4 A, 10,000-ohm rheostat	12/6
" 5 A, 100,000-ohm potentiometer	12/6
" 6 A, 25,000-ohm pick-up volume control	12/6
" 7 A, 50,000-ohm fourth terminal pick-up fader volume control	15/-

Write for our 1930 catalogue and audio manual. It tells you all about Electrad resistances, volume controls, power amplifiers, etc. for electrical gramophones.

Send 6d. in stamps for this 68-page booklet.

**ROTHERMEL CORPORATION Ltd.**  
24, MADDOX ST., LONDON, W.1.

'Phone: Mayfair 0578-9.

## MINIMUM LOSS

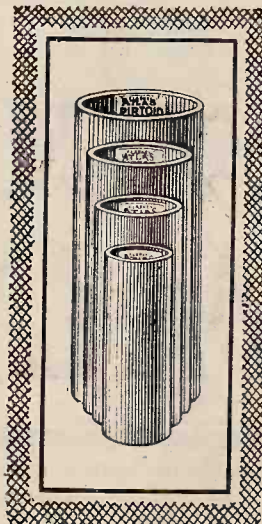

Hard and tough, almost unbreakable, "Atlas" Pirtoid Tubing is a unique and far superior material for High Frequency Transformers, Aerial Coils, etc. Drills and taps like hard wood or bone. "Atlas" Pirtoid Tubing can be obtained in any usual diameter, thickness of wall and length.

CLARKE'S  
**"ATLAS"**  
PIRTOID  
TUBING

Write for full particulars to the Sole Makers:  
**H. CLARKE & CO. (M/CR) Ltd.,**  
ATLAS WORKS,  
OLD TRAFFORD, MANCHESTER.

Mention of "The Wireless World," when writing to advertisers, will ensure prompt attention.

# Go home and listen to the MADRIGAL



Patent No. 317566

## The MADRIGAL The Instrument with the Golden Voice

The "Madrigal" Receiver only, in walnut or mahogany, handsomely figured and polished. Price, including all valves and royalties, for A.C. or D.C. Mains - - £30 : 0 : 0  
 Pedestal only, with moving coil loud speaker for D.C. - - - - - £15 : 15 : 0  
 Pedestal only, with moving coil loud speaker and rectifying equipment for A.C. - - - - - £18 : 18 : 0

Here at last is a musical instrument so near to perfection that reproduction, whether of a full orchestra or individual soloist, is so faithful that it is difficult to realise that the invisible æther alone is the sole medium between the "Madrigal" and the source of transmission. *Eminent musicians and scientists agree that the "Madrigal" will be standard radio for many years, and they are safe in their decision.*

The moving coil loud speaker within the pedestal has been selected for its perfect fidelity in reproduction of all sounds within the frequency range of Broadcast transmission. The absence of any aerial or earth, or even a frame aerial for the local station and Daventry, makes the instrument non-directional. The rubber-tyred castors enable it to be wheeled into any room at will, and a single connection to any lamp-holder or power point provides all the power. There are no batteries dry or wet.

The consumption of current is ridiculously low : less than a 50-watt lamp for both speaker and set. The cabinet work is a delight to the eye.

It is impossible here to give more than a brief survey of the many points which are of interest to every Radio Listener, but you can learn all about the instrument by asking your dealer for one of the artistic coloured folders; of the "Madrigal," in which are included the latest test reports from the Press. That you will ask for a demonstration after reading it, is inevitable.



12, HYDE STREET,  
LONDON, W.C.1.

Advertisements for "The Wireless World" are only accepted from firms we believe to be thoroughly reliable.



## FOR ELIMINATOR CIRCUITS

You cannot afford to use any but the best Condenser in an eliminator circuit.

### HELSEBY CONDENSERS

are made and guaranteed by a firm with 30 years' experience in condenser making, from small telephone and radio condensers to Power Condensers weighing upwards of 2 tons.

Guaranteed working voltages :-

Type M	-	150 volts D.C.
Type 2A	-	350 volts D.C.
Type 3A	-	450 volts D.C.
Type 4A	-	600 volts D.C.

All Helseby Condensers are vacuum dried and impregnated with a special non-hygroscopic material which renders them moisture proof.

If unobtainable from your dealer, write to us giving his name and address.



## BRITISH INSULATED CABLES LTD

PRESCOT - LANCS.

Makers of PRESCOT and HELSEBY cables

## Fit the DUBILIER BATTERY

Fitted with the long-life Dubilier Battery, your Set will give better quality performance over 66 volts a longer period. And it costs less! 7/9 Other Voltages Available.



Ask your dealer for a copy of the Dubilier Booklet—"A Bit about a Battery."

DUBILIER CONDENSER CO. (1925), LTD., Ducon Works, Victoria Road, North Acton, London, W.3.

—it is Cheaper than others—has longer life, and is British Made.

Cleaver B22

## DONOTONE THE BEST LOUD SPEAKER

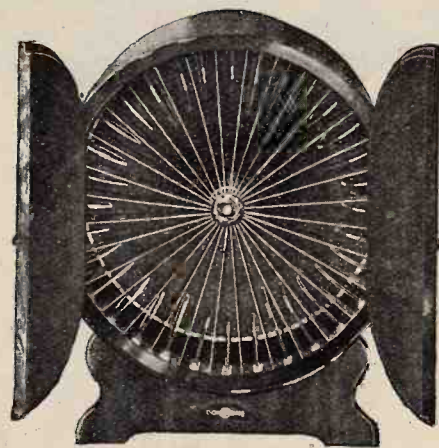

FROM 5 GNS.

The wonderful Loud Speaker with the tuned gongs which impart crispness and brilliance together with real purity and increased volume.

DEMONSTRATIONS DAILY.

THE DONOTONE (Regd.) LOUDSPEAKER, Dept. C 49, Farnival Street, Holborn, London, E.C.4.

Phone: HOLBORN 0523.

Mention of "The Wireless World," when writing to advertisers, will ensure prompt attention.

AB

# REPLACE IT WITH A BURTON!

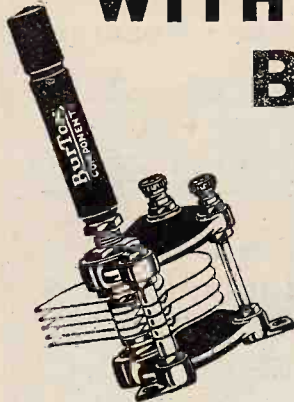

**BURTON REACTION CONDENSER.**  
Base-board mounting type. Price **4/-**

Every BurTon component embodies every latest improvement! It is at BurTon's Progress Works where these improvements are first discovered, first experimented with and first utilized —others follow. Examine your set! Replace any defective part with a BurTon!



## BURTON DIFFERENTIAL CONDENSER.

A new addition to the famous range of BurTon Condensers. Scientifically designed, brass vanes, interleaved with Bakelite leaves, this condenser makes shorting an impossibility. It means easier tuning, better selectivity and better detection.  
The price is only **5/-**

**BURTON BATTERY SWITCH.**  
Super finish, with Ebonite Knob and Nickel Plated. Price **1/-**  
With metal knob. Price **9d.**

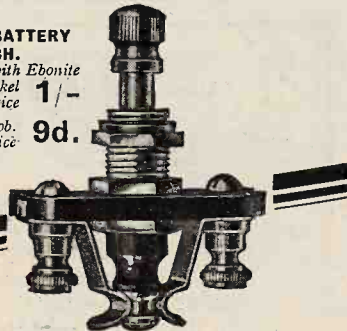

# BUY BURTON COMPONENTS

C. F. & H. BURTON, Progress Works, Walsail.

**BURTON RESISTER CONTROLS.**  
Supplied in 3, 6, 10, 15, 30 and 60 ohms resistances. Price **2/9**



## The FERRANTI A.C. Mains Receiver

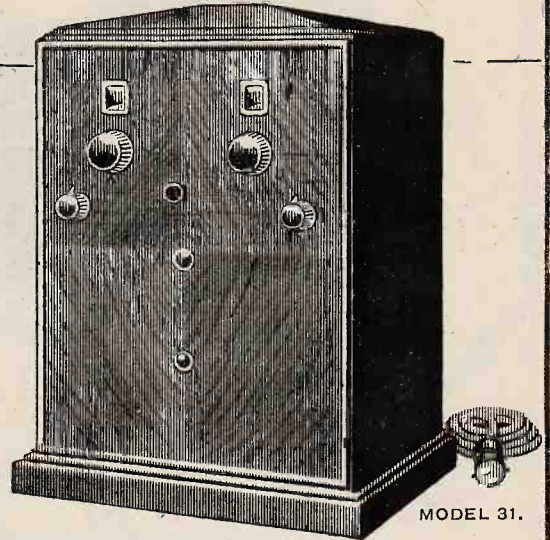

MODEL 31.

**PRICE, including Valves:**  
In Oak £25. In Mahogany £26. In Walnut £26  
Royalty £1 extra.

Handsome both in appearance and in the sense that 'handsome is as handsome does'; for the reproduction is very nearly true to life, and manipulation is of the simplest.

Available for Alternating Current only.  
Voltages: 200/250, 40 cycles or over.

FERRANTI LTD. HOLLINWOOD LANCASHIRE



## IF YOUR SUPPLY MAINS ARE D.C.

You can use an A.C. All Electric Receiver  
By Employing The M.L.—D.C. to A.C.

## ROTARY TRANSFORMER

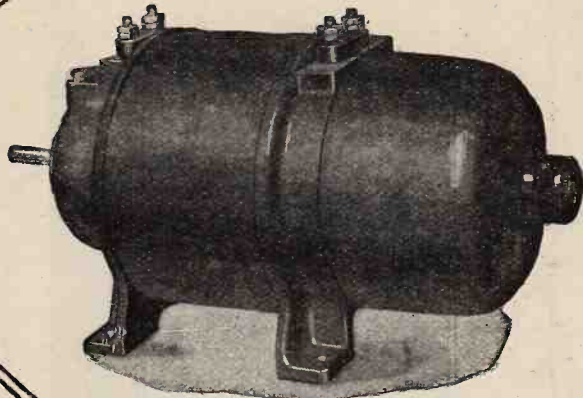

*Recommended and  
used by*

Philips Radio,  
Marconiphone,  
Burndept,  
Kolster-Brandes,  
M.P.A., Etc., Etc.

Can be supplied  
to run from  
any Voltage  
12-250 V.D.C.

40 WATT Model  
£13-0-0

85 WATT Model  
£19-0-0

M-L MAGNETO SYND. Ltd., Radio Dept., COVENTRY.  
Telephone: 5001.

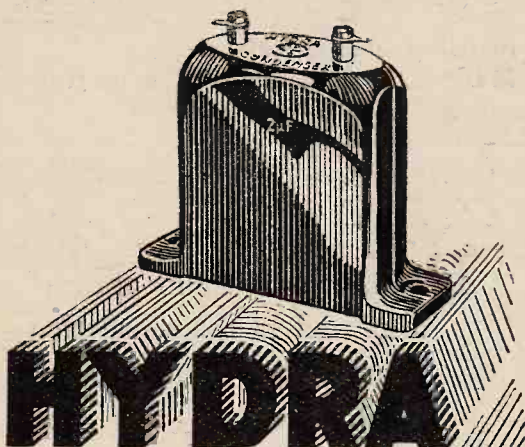

## THE STRONG POINT IN ANY MAINS UNIT!

The impregnable insulation of the paper dielectric in a Hydra Condenser is the "strong point" in any eliminator. When you put Hydra into the circuit, you cut out once and for all the risk of condenser-trouble—you safeguard your set and all who handle it.

*The best eliminators you can buy  
contain Hydra Condensers—write  
for list of makers' names.*

LOUIS HOLZMAN, 37, Newman Street, London, W.1.

## DURING RADIO WEEK

Will Day Ltd., as always, are co-operating with British Radio manufacturers, and all wireless receivers, component parts and accessories can be obtained immediately. Deal with a firm that has a *real* British reputation second to none.

### ALL MAINS RECEIVERS

Dubilier - (3-valve) £25  
39. Marconi (3-valve) £21  
Lotus - (3-valve) £21

ALL TYPES OF

LOUD SPEAKERS  
PORTABLE SETS  
RADIO-GRAMS

supplied on easy payments.  
Details and catalogue on request.

**WILL DAY LTD.**  
19, LISLE ST., LONDON, W.C.2.

'Phone: Regent 0921-22.

Mention of "The Wireless World." when writing to advertisers, will ensure prompt attention.

All who prefer Quality  
in Cigarettes



Say  
Player's  
Please.

5 for 3d. 10 for 6d.  
20 for 11½d.



N.C.C. 792

**Pertrix once —**



**Pertrix always**

**The Battery without CRACKLE**

Once use a "Pertrix" H.T. Battery and no other will content you. Being devoid of the ordinary sal-ammoniac electrolyte, "Pertrix" possesses these unique qualities:

- (a) It cannot develop "crackle."
- (b) It cannot lose power when out of circuit.
- (c) It gives—on every test—60% longer life.

**60%**  
LONGER LIFE —

**PERTRIX**  
SUPER  
H.T. BATTERIES

PERTRIX Ltd., Britannia House, Shaftesbury Avenue, London, W.C.2  
Factory—Britannia Works, Redditch, Worcs.



**THE  
POPULAR  
LOTUS  
ALL ELECTRIC  
RECEIVER**  
for  
**£19-9**  
DOWN

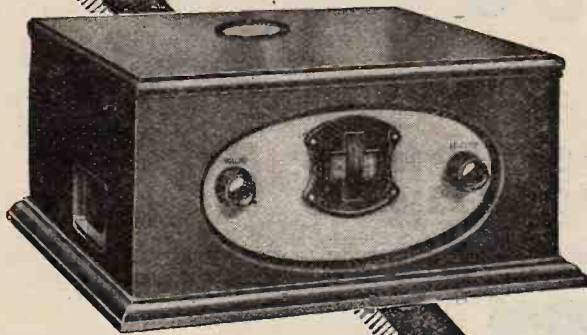

Go home and listen  
Radio Week 12th to 18th January

Easily operated by connecting to any A.C. Mains light socket—no batteries needed—this Lotus All Electric 3-valve S.G.P. Set is highly selective and covers a good range of British and Continental stations. Cash price £21 (Royalties paid, and including valves). The same circuit is used in the Lotus 3-valve S.G.P. Battery Model—Cash price £13 : 15 : 0.

For home construction get the Lotus 3-valve S.G.P. Battery Model Kit at £7 : 12 : 6. cash. See and hear these sets at any wireless dealer's or write to-day for the Lotus Sets Catalogue and Hire Purchase terms.

**LOTUS**  
**ALL ELECTRIC  
RECEIVER**  
*Gets the best reception.*

*Made by the makers of the famous Lotus components in one of the most modern radio factories in Great Britain.*

**GARNETT WHITELEY & CO., LTD., Dept. W.W.4,**  
Lotus Works, Mill Lane, Liverpool.

**NATIONAL  
RADIO  
WEEK**

**JANUARY 12th to 18th,  
1930.**

*We regret that some of our customers were disappointed over delivery at Xmas. With the New Year we are extending our factory to meet the demand.*

**Get the Experts to  
Advise You :—**  
**The R.G.D. Radiogramophone**

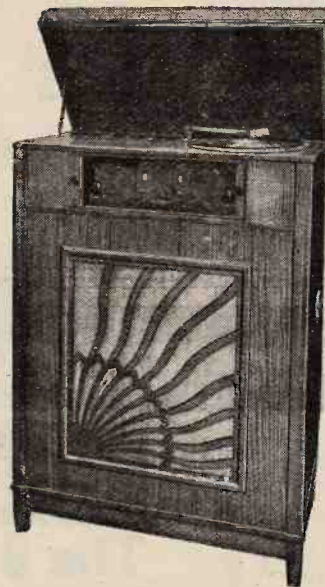

For the highest possible quality and tone for both radio and record, with ample volume, incorporating the latest developments in moving coil speaker; operates entirely from electric mains, A.C. any voltage, or D.C. 200 volts or over.

Mahogany  
**£80**

**A Pick-Up  
of  
Distinction.**



The R.G.D. Magnetic Pick-up is designed after years of experiments, and we believe it to be as perfect as possible. No record wear, perfect tracking, a scientific instrument, specially developed for moving coil speaker reproduction. Price £3 in bronze, £3-3-0 in oxidised silver.

*Place your order now to ensure delivery and we shall be pleased to supply literature on application.*

**The Radiogramophone Development Co.,**  
St. Peter's Place, Broad Street, Birmingham.

Mention of "The Wireless World," when writing to advertisers, will ensure prompt attention.



# DUBILIER FOR DURABILITY



MICA CONDENSER. Type B775  
 '01 4/- '18 6/- '5 37/6  
 Intermediate capacities at proportionate prices



PAPER CONDENSERS

.01 to .1	Each	2/-
.125 and .2		2/3
.25 and .3		2/6
.4 and .5		2/6
1.0		2/6
2.0		3/6

Prices of higher values on application

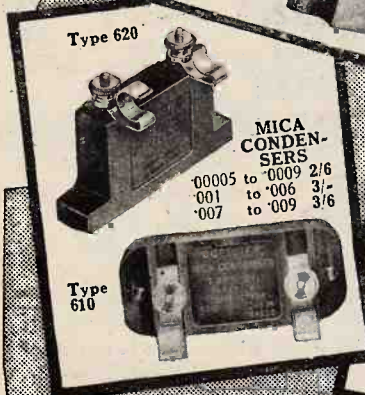

MICA CONDENSERS

00005 to 0009	2/6
001 to 006	3/-
007 to 009	3/6

Ask your dealer for the Dubilier Booklet—"A Bit about a Battery"—it's free.

If you have any difficulty in obtaining Dubilier products write to us direct giving the name and address of your dealer

"Go Home and Listen"  
 Radio Week, Jan. 12-18

# DUBILIER FIXED CONDENSERS

Dubilier Condenser Co. (1925) Ltd., Ducon Works, Victoria Road, North Acton, London, W.3

Cleaver

BC277F

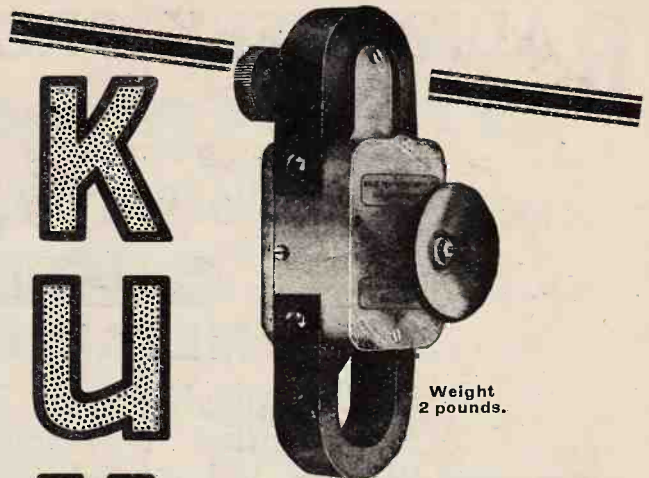

Weight 2 pounds.

# K U K O O

## The SUPER SPEAKER UNIT

Without fear or favour we claim the "Kukoo" unit to give results equal to Moving Coil. Radio Experts and Music Critics are agreed that for faithful reproduction over all transmitted frequencies it leads the field.

**Do Not Believe  
 Our Claims only—  
 READ THIS PROOF!**

**TOM PRENDERGAST**  
 24, UPPER BROOK ST., GOSM. MANCHESTER

*7/12/29*

*Genl. I have tested the "Kukoo" L.S. (Baffle Board 36") & have obtained absolutely Moving Coil results. Wonderful. Thanks.*

*Yours etc.  
 Prendergast.*

Sole Patentees & Manufacturers —  
 THE SHEFFIELD MAGNET CO.  
 BROAD LANE, SHEFFIELD.

\*Phone —20866.

\*Grams.—Magnet 20866 Sheffield.

Specially designed Kukoo Chassis and 10 1/2" Cone, 15/6 post free.



Postage 9d. extra.

# RADIO WEEK PROGRAMMES (Jan. 12th-18th)

are being particularly appreciated by the fortunate possessors of trouble-free radio equipment, in which

THE



## METAL RECTIFIER

is now playing such a prominent part. Once this rectifier is installed it can be forgotten, because it has nothing to wear out, no fragile filaments, chemical action, or moving parts.

The majority of modern A.C. mains receivers, eliminators, and battery chargers incorporate this rectifier. See that your new equipment includes it.

For those who prefer to make up their own sets, our book "The All-Metal Way, 1930" will be invaluable. It contains 32 pages of circuits and instructions covering all types of A.C. Mains Units. Send a 2d. stamp with your name and address.

The Westinghouse Brake & Saxby Signal Co. Ltd.,  
82, York Road, King's Cross, London, N.1.

### AN INDOOR AERIAL



The neatest and quickest way to fix an indoor aerial is to use these

### ELECTRON INSULATOR PINS

Fixed in a moment to your picture rail, skirting or any convenient place, they hold the aerial so neatly that both the aerial and pins are practically invisible.

With Electron Indoor Aerial Insulator Pins a directional Aerial can be instantly removed and fixed at different angles at either end or across the room; simply pull out the Pins and fix in varying positions until the best results are obtained.

PRICE PER BOX

6<sup>d</sup>

POST FREE

The NEW LONDON ELECTRON WORKS Ltd.  
EAST HAM LONDON. E.6

For your indoor aerial use Superior, Electron's Super Aerial, boxed in 100 ft. lengths. Price 2/6

### THE BEST OF THE BRITISH UNITS.

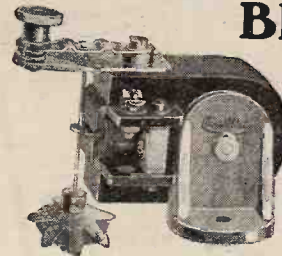

18/6

complete with cone clamps and aluminium brackets as shown, enabling exact centre adjustment to be made.

Before you buy a unit for your cone speaker, send for a leaflet on this Watmel Unit. Both in theory and in practice this is the best unit yet turned out either in this or in any other country.

Magnets of Cobalt Steel, pole pieces of turbo stalloy, armature of best charcoal annealed iron, positive adjustment and true four-pole action combine to make this a unit of outstanding performance and sensitivity. Fully descriptive folder No. 101 comes free on application, and shows you how you can build a complete loud speaker, including magnificent oak cabinet, from a kit of parts costing only 55/-.



WATMEL WIRELESS CO., LTD., Imperial Works,  
High St., Edgware, Mx.  
Telephone: Edgware 0323.

P & T



# 13 ELECTRICAL INSTRUMENTS IN 1 The "AVOMETER"

MEASURES

**AMPS, VOLTS and OHMS**

without calculation of any kind.

**NO EXTERNAL SHUNTS OR MULTIPLIERS.**

The 13 ranges of the  
"AVOMETER"

are as follows:

- |                  |           |
|------------------|-----------|
| 0-12 Milliamps   | } Amperes |
| 0-120 Milliamps  |           |
| 0-12 Amperes     |           |
| 0-120 Millivolts | } Volts.  |
| 0-12 Volts       |           |
| 0-120 Volts      |           |
| 0-1200 Volts     |           |
| 0-1000 Ohms      | } Ohms.   |
| 0-10,000 Ohms    |           |
| 0-100,000 Ohms   |           |
| 0-1 Megohm       |           |

**BRITISH THROUGHOUT.**

No printing matter can possibly convey the numerous uses to which this Instrument can be put. One of the largest firms in the world informs us that "THE VALUE OF THE 'AVOMETER' CANNOT POSSIBLY BE APPRECIATED UNTIL IT IS IN ACTUAL USE."

This concern has purchased over 80 "AVOMETERS" and is still ordering.

THE AUTOMATIC COIL WINDER & ELECTRICAL EQUIPMENT Co., Ltd.

WINDER HOUSE, ROCHESTER ROW,  
LONDON, S.W.1.

Phone: VICTORIA 4350.

Price £8.8.0  
DEFERRED PAYMENTS ARRANGED.

103

# Radio's Supreme Power



ARE YOU PROUD  
OF YOUR NEW SET?  
DO IT JUSTICE  
AND FIT THE BEST  
POSSIBLE BATTERY

Grosvenor Batteries give continuous and satisfactory service because they incorporate a new vitalising element which is unique to Grosvenor.

66 v. from 7/6	Super Capacity for Multi-Valve Sets	66 v. 20/- 99 v. 32/6
99 v. .. 11/6		



# The Grosvenor Battery

BRITISH MANUFACTURE

GROSVENOR BATTERY CO., LTD., 2-3, White St., MOORGATE, LONDON, E.C.2. Phone. Met. 6865



**LOCKED for SAFETY**  
**LOCKED for LONG LIFE**  
 THE ONLY SCREENED GRID VALVE WITH INTERLOCKED CONSTRUCTION

**L**OCKED top and bottom—braced to a girder-like rigidity—the elements of the *NEW* Cossor Screened Grid Valve are definitely immovable. This Cossor system of Interlocked Construction ensures a remarkable degree of strength—far greater than ever before attained in any valve. As a result the *NEW* Cossor Screened Grid Valve has an exceptionally long life—it is shock-proof, noise-proof and break-proof. Use the *NEW* Cossor Screened Grid in your Receiver—it is Britain's strongest and most dependable Screened Grid Valve.

**2-volt type now available.**

The *NEW* Cossor 220 S.G. (2 volts 2 amp.).  
 Anode volts 120-150. Impedance 200,000.  
 Amplification Factor 200. Price **22/6**

Cossor 4 and 6 volt Screened Grid Valves are also available with similar characteristics at the same price.

A. C. Cossor Ltd., Highbury Grove, London, N.5.

Mention of "The Wireless World," when writing to advertisers, will ensure prompt attention.

The NEW  
**COSSOR**  
 Screened Grid  
 Valve

3130 

A14

# The Wireless World

AND  
RADIO REVIEW  
(17<sup>th</sup> Year of Publication)

No. 542.

WEDNESDAY, JANUARY 15TH, 1930.

VOL. XXVI. No. 3.

Editor: HUGH S. POCOCK.  
Assistant Editor: F. H. HAYNES.  
Editorial Offices: 116-117, FLEET STREET, LONDON, E.C.4  
Editorial Telephone: City 9472 (5 lines).  
Advertising and Publishing Offices:  
DORSET HOUSE, TUDOR STREET, LONDON, E.C.4.  
Telephone: City 2847 (13 lines). Telegrams: "Ethaworld, Fleet, London."  
COVENTRY: Hertford Street.  
Telegrams: "Cyclist, Coventry." Telephone: 5210 Coventry.  
BIRMINGHAM: Guildhall Buildings, Navigation Street.  
Telegrams: "Autopress, Birmingham." Telephone: 2970 and 2971 Midland.  
MANCHESTER: 260, Deansgate.  
Telegrams: "Hiffe, Manchester." Telephone: 8970 City (4 lines).  
GLASGOW: 101, St. Vincent Street, C2.  
Telegrams: "Hiffe, Glasgow." Telephone: Central 4357.  
PUBLISHED WEEKLY.  
Subscription Rates: Home, £1 1s. 8d.; Canada, £1 1s. 8d.;  
other countries abroad, £1 3s. 10d. per annum.  
Entered as Second Class Matter at New York, N.Y.  
*As many of the circuits and apparatus described in these pages are covered by patents, readers are advised, before making use of them, to satisfy themselves that they would not be infringing patents.*

## CONTENTS OF THIS ISSUE.

	PAGE
EDITORIAL VIEWS	50
PERMANENT MAGNET MOVING COIL LOUD SPEAKER. BY F. H. HAYNES	60
HIGH SELECTIVITY (CONCLUDED). BY W. T. COCKING	66
CURRENT TOPICS	69
AN AID FOR THE DEAF	71
WIRELESS THEORY SIMPLIFIED. PART XVII. BY S. O. PEARSON	72
NEW APPARATUS REVIEWED	75
SOUTHERN WIRELESS SHOW	76
LETTERS TO THE EDITOR	77
BROADCAST BREVITIES	80
READERS' PROBLEMS	81

## A WIRELESS LICENCE SCANDAL.

A WIRELESS receiving licence costs but 10s. a year, and this is not a large sum when we consider the hours of programmes to which it entitles us. *The Wireless World* has always supported the authorities in their insistence that the licence should be regularly paid, and we have approved of the attitude of the Post Office in bringing to book those who deliberately neglect to pay the annual fee. We have gone to considerable trouble to explain to readers who have written to us, and we have also published an interpretation of the regulations concerning the use of more than one wireless set in the same building.

### Our Statement Officially Approved.

The Post Office has officially approved of the wording of the paragraph in which we have expressed the position as follows: "A single receiving licence will cover the installation of more than one set, provided that the sets are all in the same house, flat, etc., that is to say, tenants of separate flats or sub-let premises in the same building are not entitled to share the benefits of one licence, nor may

extensions be made from a licensed set whereby the occupiers of other houses, flats, etc., may listen without taking out separate licences."

In view of this statement of the position officially approved by the Post Office, we were astonished to read in the daily Press recently that the Post Office had agreed that a single 10s. licence was sufficient to cover a wireless receiving installation which supplied 200 separate luxury flats apparently for the reason that they happened to be all within one building.

### An Irregular Decision.

We cannot believe that this is a proper interpretation of the licensing position, and we draw special attention to this case because we feel that it should at once be looked into by the Post Office, and, even if fresh regulations are necessary to meet the situation, they should be made in order that individual tenants of the flats may be called upon to pay separate licences for broadcast listening.

We believe that legally the Post Office would find it difficult to enforce the payment of a licence fee on apparatus capable of receiving wireless broadcasting but which, in fact, was not being used by the owner for that purpose. This seems to point to the monopoly of the Post Office covering the use of apparatus for the purpose of listening rather than the ownership of the apparatus, so that we contend that in a building where one receiving set is installed it is even more important that the licence should be paid by those residents in the building who have separate loud speakers or telephones which they use for the purpose of listening than that the receiving installation itself should be licensed. Furthermore, it might be argued that under the Telegraphy Act, 1869 (Sections 4 and 5), the Post Office is entitled to a rental in respect of the extension lines to the individual flats.

If the Post Office attempts to justify their action in accepting one annual payment of 10s. for a licence for the installation in question which supplies 200 luxury flats, then we regard the position as little short of a scandal. The cottager and even the family living in one room is, under the present regulations, required to pay the 10s. licence, however difficult it may have been to raise the necessary money for the wireless set and to pay the annual licence, and this being so, why should residents in luxury flats enjoy the advantages of broadcast reception with first-class quality from an ideal and expensive receiving set without being called upon to contribute in any way towards the cost of programmes, whilst the poorer members of the community enjoy no such privilege?

# Permanent Magnet Moving Coil Loud Speaker



A Solution to the Field  
Current Problem.

By  
F. H. HAYNES.

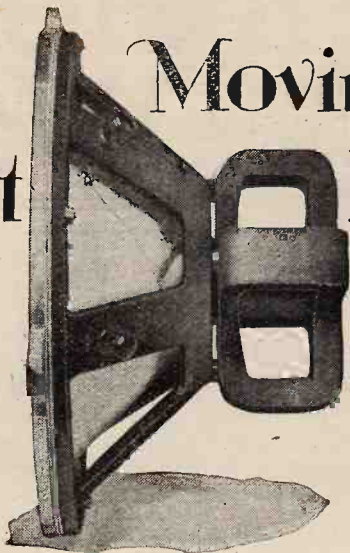

WHILE it is now nearly three years ago since this journal first introduced moving-coil loud speaker designs little attention has been drawn to the possibility of dispensing with the field-energising current by the adoption of permanent magnets. In consequence the moving-coil loud speaker is restricted in its use to where electric supply mains are available, as the current demanded by the electro-magnetic field cannot be maintained by a portable accumulator. Attempts to use permanent magnets have proved unsatisfactory inasmuch as the flux density produced has invariably been inadequate. There is little point in using a weak field and hoping to make up for the loss of signal strength by the use of a generous winding on the moving coil, fed with the output from several parallel-connected power valves. In so doing the behaviour of the loud speaker may become less linear over the frequency range due to an increase in the mass, inductance and capacity of the winding, the current consumed by the output stage can only be provided by the use of supply mains, while the smallness of the gap and the largeness of the coil impose a limit beyond which one cannot go.

A minimum flux density of 10,000 lines to the square centimetre has been assessed in respect of the electro-magnetic type of field, and to produce this value in a gap of sufficient width and area requires a field winding dissipating up to some 30 watts. In this case the gap has a width of  $\frac{1}{2}$  in. and an area of about 20 sq. cms. To halve the width of the gap about one quarter of the field wattage is needed to produce the required field strength. Similarly with permanent magnets, to halve the area of the

gap will nearly double the amount of available magnetic flux, while to halve its width will, in a well-designed magnet, increase the flux nearly four times. A compound permanent

magnet that is intended to produce a high flux density across a small gap is by no means easy to design. Special forms of cobalt steel must be utilised to create the necessary high flux within a magnetic circuit of reasonable size and cross-section. Precautions must be taken to ensure that the flux can be carried by the iron where the cross-section narrows towards the gap, while the magnetic leakage is governed by the shape, and saturation is kept to a minimum so that the field is concentrated within the space to be occupied by the moving coil. Many instances have come to the writer's notice of attempts to construct a compound permanent magnet in which it was hoped that the total flux

when added would produce the required density at the gap. Measurement has shown, however, that the flux density is much lower than was anticipated, while the performance of the finished loud speaker was inferior in quality to an electro-magnetic type working from a given output stage.

It was not until the Exhibition of last September that attention could hopefully be turned to the possibilities of a reasonably compact permanent magnet. Many readers must have examined with interest the moving-coil loud speaker magnets, then just produced, and shown at the stand of Swift Levick.<sup>1</sup> These magnets

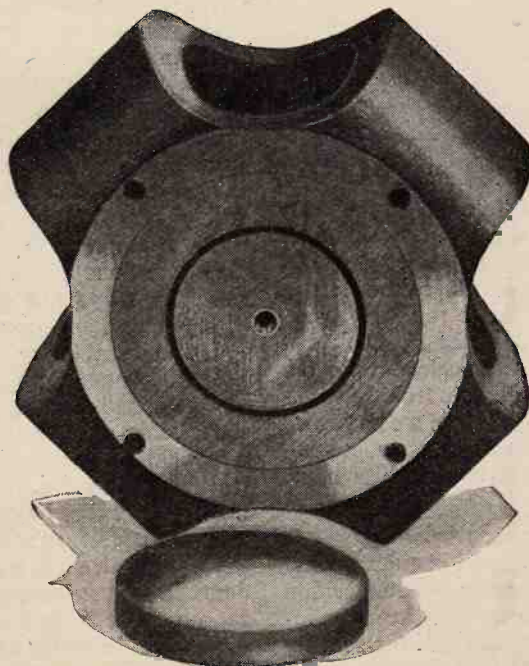

Permanent magnet with 1.5 mm. gap and fitted with soft iron pole pieces. Flux density 8,000 lines to the sq. cm.

<sup>1</sup> Designed by G. D. L. Horsburgh, Swift Levick & Sons, Ltd., Sheffield. Obtainable, together with other materials required in the construction of the complete loud speaker, from the Epoch Radio Manufacturing Co., Ltd., 3, Farringdon Avenue, London, E.C.4, and A. M. E. Sherwood, 150, King's Cross Road, London, W.C.1.

**Permanent Magnet Moving Coil Loud Speaker.**

were of only moderate size, of unique shape as regards casting and machining, and were stated to possess flux densities of the order of 5,000 lines to the square centimetre. Subsequent development by way of a small increase in size and cross-section, minor modifications in shape and the inseting of mild-steel poles to convey the concentrated flux to the gap, has now resulted in the production of magnets of an assured flux density of 8,000 lines to the square centimetre when the gap width is 1.5 mm. and the area 7 sq. cms. This area permits of a pole diameter of  $1\frac{1}{2}$  in. with a gap length of  $\frac{1}{4}$  in. We now have a permanent magnet which promises to satisfactorily replace the electro-magnet. As width of gap has so great an effect on flux density the dimensions decided upon must be no larger than is required to just accommodate the coil. On the other hand the reduction of diameter reduces the area of the gap, with consequent increase of flux, but the number of turns on the moving coil must be increased in proportion to the reduction of their diameter.

**Coils for Small Gaps.**

Our problem is now that of filling the gap to the utmost with the moving-coil winding, for if there is any space to spare this should obviously be taken up by decreasing the width or area of the gap. There is no question that the best method is that of building the moving coil as a single layer of edge-wound strip, as has long been done by the Gramophone and Western Electric Companies. Somewhat special tools are required to effect this, but the resulting coil is exceedingly stiff, requires little support, and can be relied upon to maintain its shape. For lightness the strip used may be aluminium, carrying a single covering of silk or enamel, wound so that it stands edgewise on its former. Another winding that suggests itself is three layers of No. 36 enamelled wire,

operated like the strip-wound coil, through an output transformer. For the home constructor there is another possibility in that with reasonable care he can wind a high-resistance coil, thus obviating the dangers of distortion incurred by the output transformer. A high-resistance coil designed to handle a given value of signal watts occupies a slightly greater volume than the corresponding low-resistance winding actuated

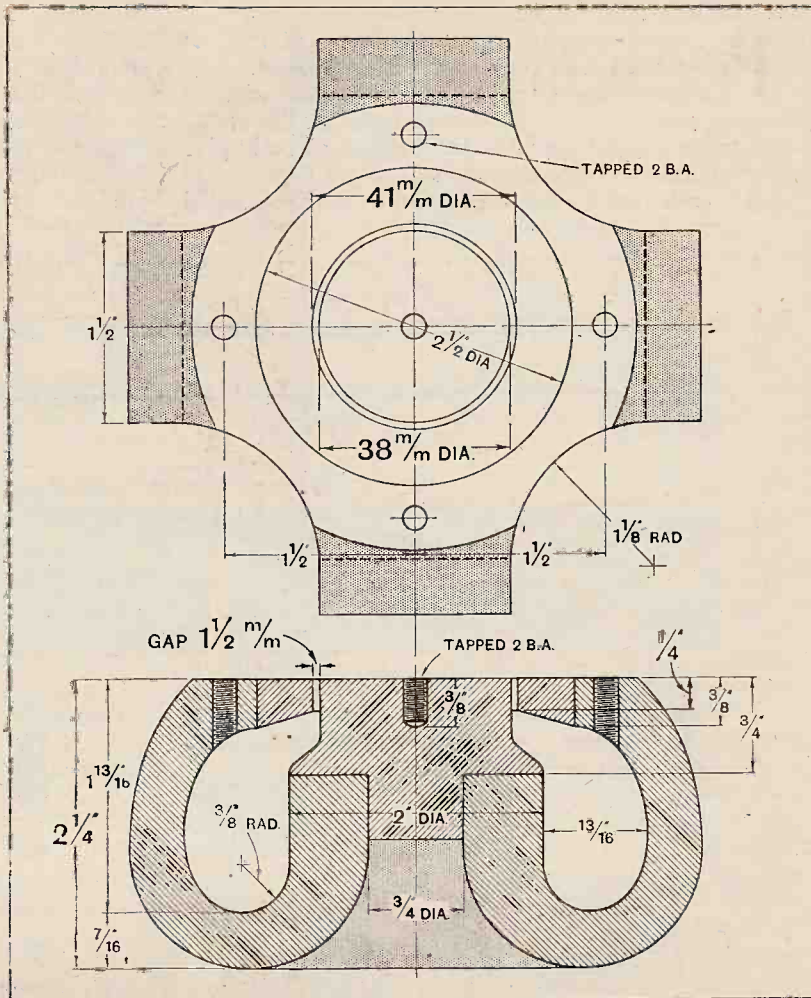

Detailed drawing of the larger type magnet with a gap of 1.5 mm. and a flux density of about 8,000 lines to the sq. cm. A smaller type magnet is available having a 2 mm. gap and giving a flux density of some 5,000 lines to the sq. cm.

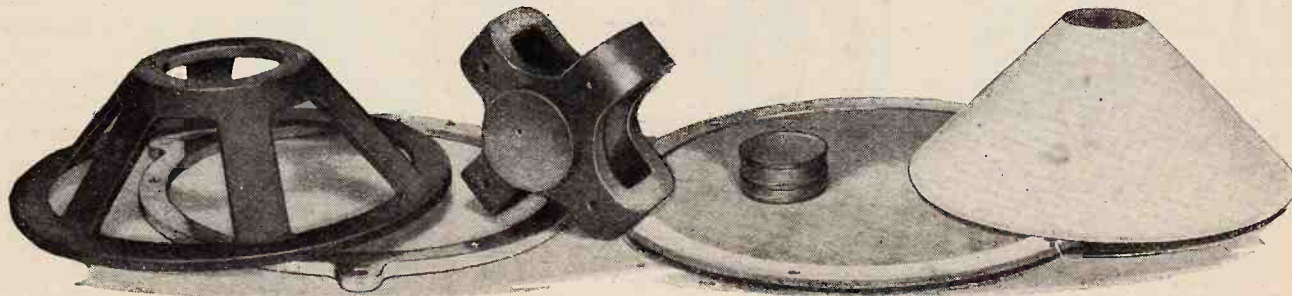

Components used in the construction of the model having the 2 mm. gap. The surround material is secured without stretching to the cardboard rings and the spare material is cut away after the diaphragm has been attached.

**Permanent Magnet Moving Coil Loud Speaker.**— through a transformer owing to the increased ratio of insulation and space to conductor. Nevertheless, there is just sufficient room for a high-resistance winding possessing the maximum number of turns for the undistorted power output specified for a valve that will give ample volume for home conditions.

Test reveals that a 1,300-turn coil of No. 48 enamelled

wire gives practically faultless results when fed from a P.625 valve. It is owing to the fact that No. 48 enamelled wire is the finest that can be conveniently handled that it has been adopted, though its signal-carrying capacity is considerably in excess of that produced in the anode circuit of the P.625 valve. Incidentally, the output from a valve such as the L.S.6A can be carried by the winding. It might be noted

here that the vast improvements that have taken place in the past year in the power output of L.F. valves makes it possible to produce adequate signal strength with less distortion, coupled with a more compact moving-coil winding.

A thin paper ("detail paper," thickness 0.004in.) former is constructed to carry the winding. It is made exact to size by wrapping round a smooth brass cylinder. Dimensions for cutting out the paper, which should be of a thin, smooth, non-shiny variety, are given in the diagrams. Two layers are wrapped round the brass cylinder, a thin coating of seccotine completely covering the faces which adhere together. Seccotine must be kept away from the interior and outside surfaces to obviate the sticking of the former to the cylinder and to permit of a subsequent treatment with shellac varnish before winding on the wire. As the turns are to be put on in a bank-wound fashion across the former, and not layer by layer, the cross-over lead of No. 42 or 44 wire is taken through under the end of the paper before sticking on the end strips which form a support to the winding.

A spindle and crank handle such as can easily be made up is used to rotate the cylinder, and care must be taken to see that the former and end pieces run true on the cylinder or otherwise the wire may ride over the edges when winding is

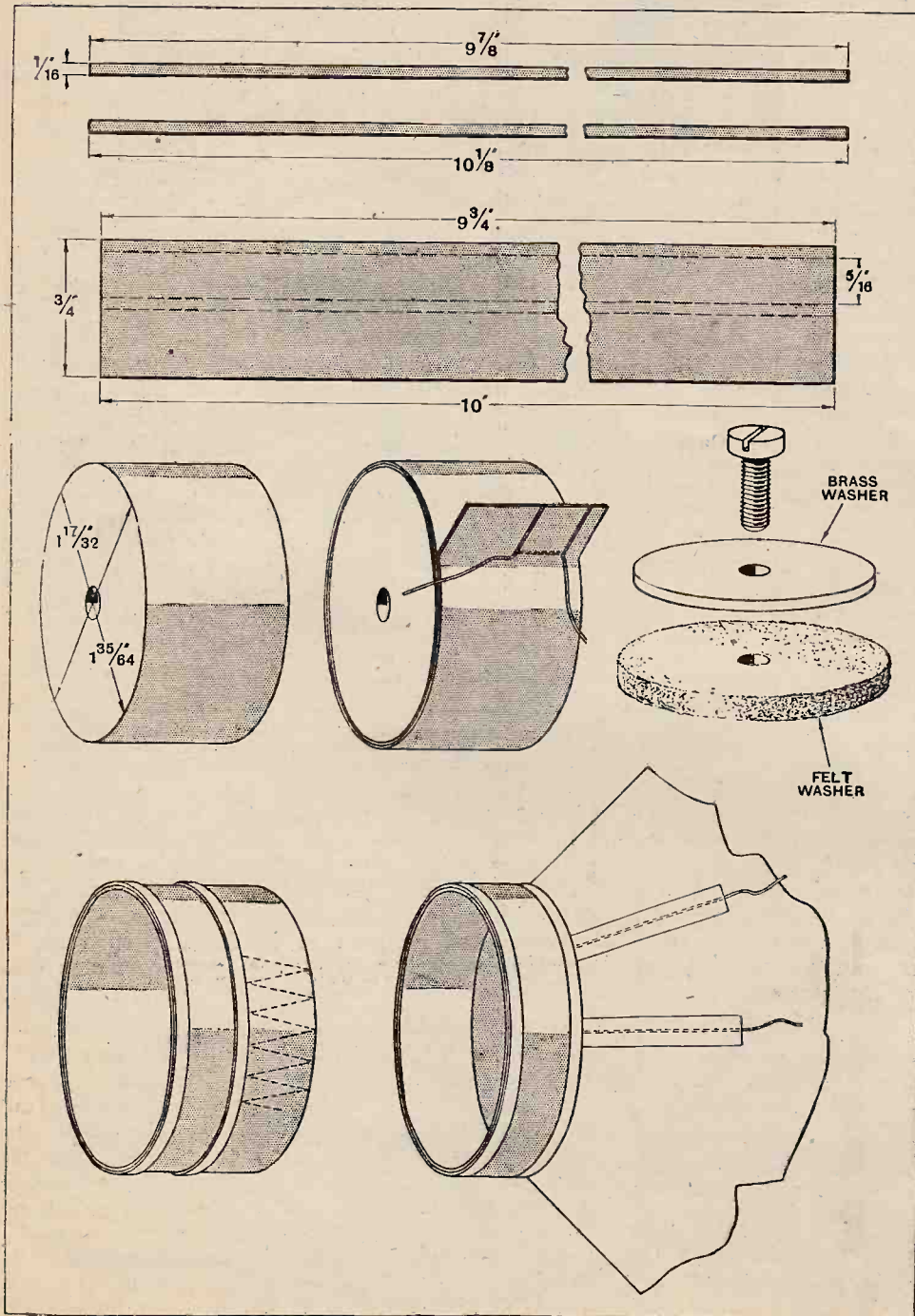

Constructional details for making the moving coil and centring device. Two dimensions are shown on the brass former, the smaller being applicable to the narrow gap (1.5 mm.).



**Permanent Magnet Moving Coil Loud Speaker.—**

commenced. The reel carrying the No. 48 wire is lightly mounted in line with the former and away from the operator. By the use of fine "blue-back" emery the enamel covering of the wire is removed and is lightly soldered, without need for twisting, to the lead out wire already provided. Allowing the wire to lightly pass through the fingers of the left hand and turning the crank with the other 200 turns are run on into one-sixth of the winding space. With care there is little danger of breakage, and a magnifying lens is useful for examining the condition of the winding. Owing to the careful attention required in handling the wire it is helpful to note down each 100 turns as completed in order to guard against an error in counting. If on completing the winding space there is room for another 100 turns, or if the former is filled with 100 turns short of the required number, there is no need to leave a space or, alternatively, to cramp the turns, but to aim at filling the former with an approximate winding. Test the former frequently to make sure that it can be released from the smooth brass centre-piece. Test the winding, also, for continuity, on completion, with a millimeter and 1.5-volt cell. The current will be 0.75 mA. It is worth while making a pair of coils while the winder is set up.

**Right Angle Cones for 1.5 mm. and 2 mm. Gaps.**

Impregnate the winding with good shellac varnish, leaving it on the cylinder to dry and frequently sliding it to ensure freedom, taking care not to burr up the

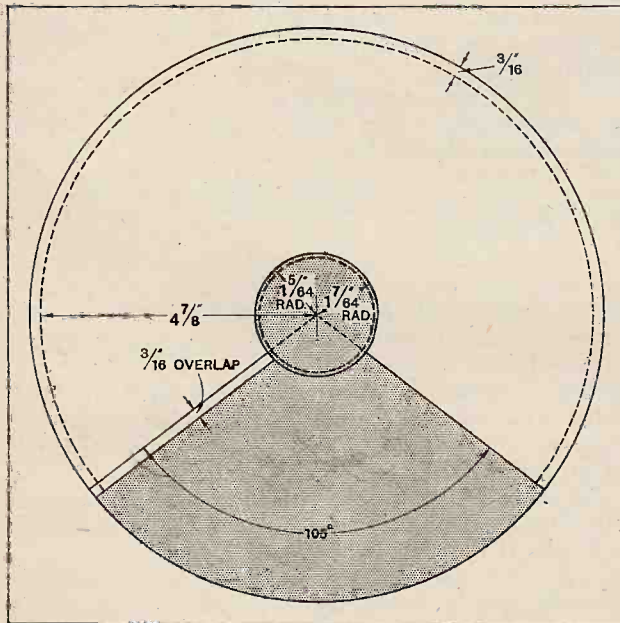

Details for cutting out the diaphragm. The centre hole has a larger radius when used with the magnet having a 2 mm. gap.

ends of the former or to crush it while forcing it free. When thoroughly dried out in front of a fire cover the winding, end-pieces with a single layer of shellac impregnated absorbent tissue paper.

What is known as "two sheet" (thickness 0.010in.)

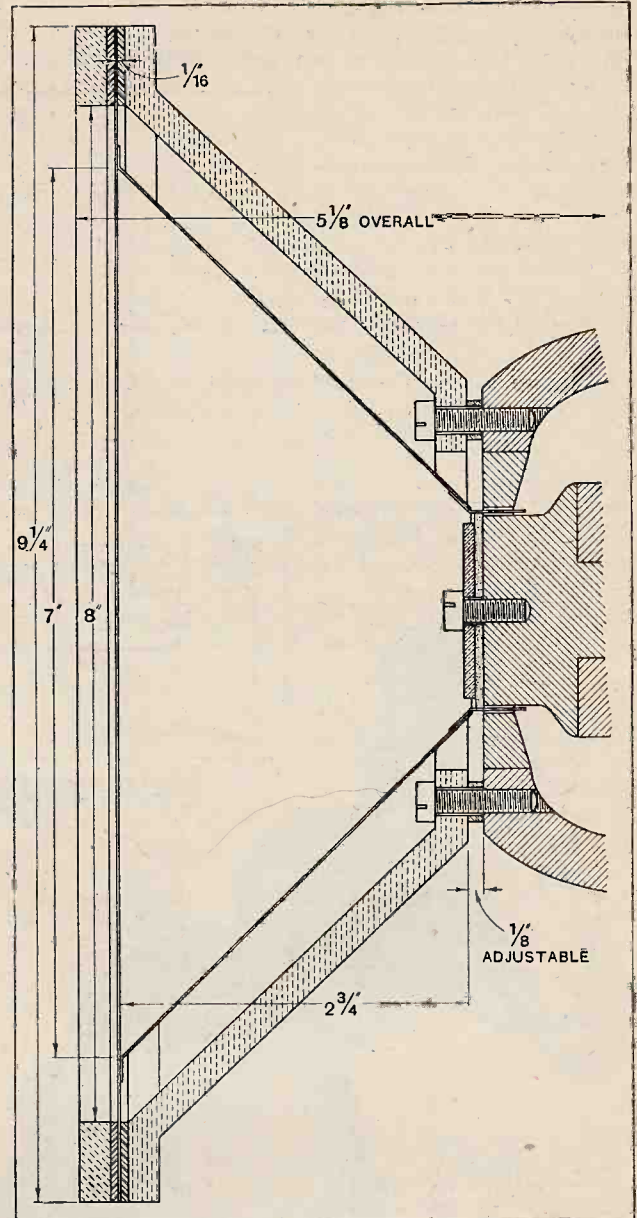

Sectional view of the finished diaphragm and cradle. Spacing washers are inserted in order that the winding of the moving coil may fall centrally within the gap.

"Bristol" board still proves to be one of the best materials for the construction of the diaphragm. The edges to be secured together are bevelled and roughened with a smooth file. A stick of wood with a saw-cut end is used to turn over the front for attaching to the surround. With a pair of sharp side-cutting pliers the points are made on the end of the former at intervals of about 1/4 in., taking care not to injure the leading out wires. While held on the brass cylinder shellac is removed from the outer face of the points, and these are then roughened with the file. A tight fit should result when the former is brought up to the diaphragm, and, assuming the end ring has been carefully mounted,

**Permanent Magnet Moving Coil Loud Speaker.**—the axes of coil and diaphragm will coincide. While still holding the coil with the aid of the brass cylinder the joints are turned back on to the seccotine-coated rim of the diaphragm, and after, perhaps, a quarter of an hour they will be found to hold in position. The blade of a penknife can be used to press them down, following round from point to point until the seccotine has hardened. One loose or split point will give rise to rattle.

A pair of cardboard rings are cut and secured with seccotine, coinciding on the two sides of the surround material. While leather is still regarded as one of the

careful that the grain in the cloth does not cause the edge of the razor to wander from the circle. In planning the diaphragm and its aluminium flange allowance

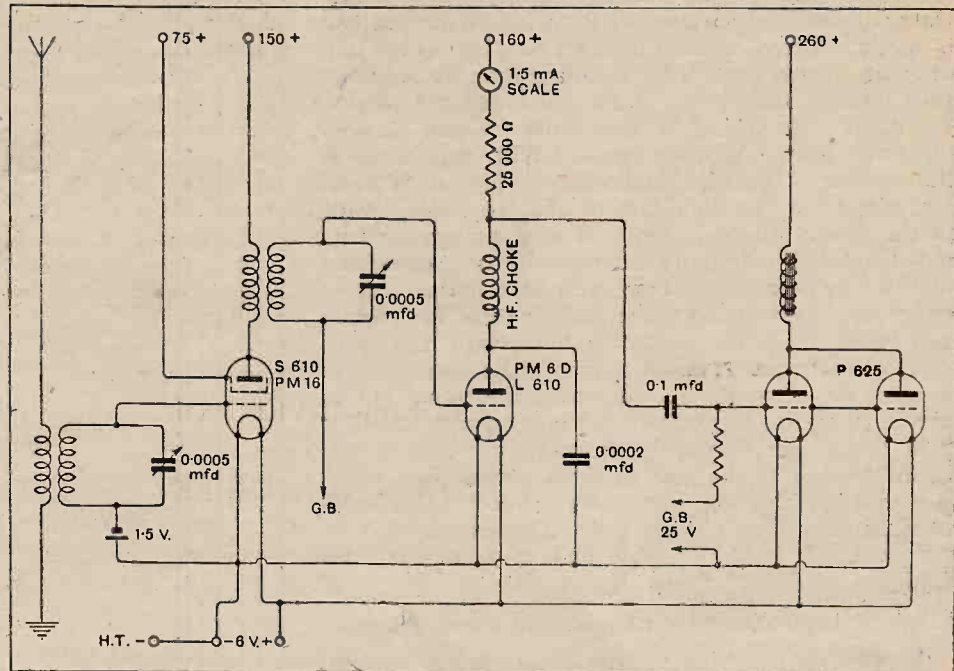

Circuit for quality reception from a local station. Suitable values are given and it is assumed that when operated from an eliminator the voltage regulating resistances will be arranged to avoid interstage coupling.

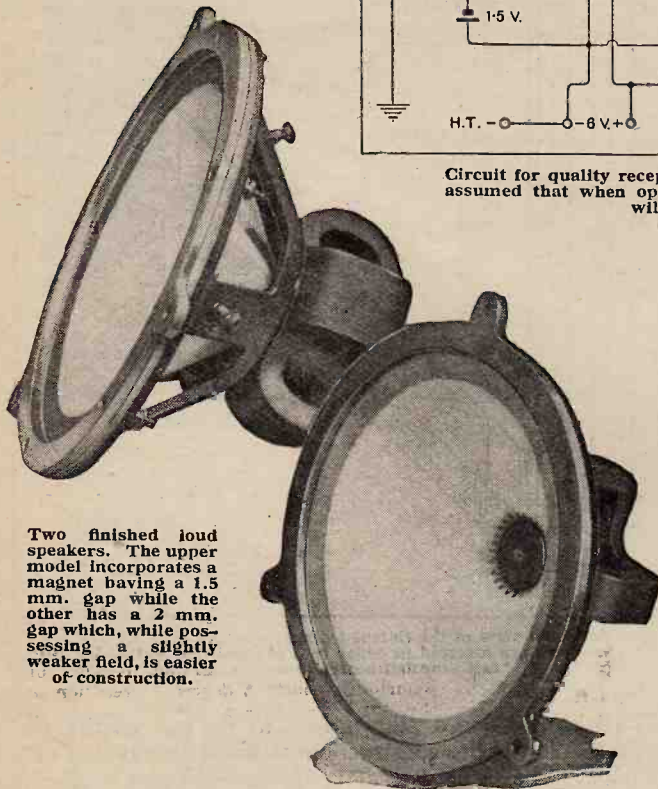

Two finished loud speakers. The upper model incorporates a magnet having a 1.5 mm. gap while the other has a 2 mm. gap which, while possessing a slightly weaker field, is easier of construction.

most satisfactory materials for constructing the surround thin rubberised cloth ("Britcam") is used in this instance as it is convenient to work and can be made to lie flat without tensioning. With the card rings securely fixed the diaphragm is attached concentrically, the edge being "ironed" down. When dry, cut a rough hole in the centre of the rubberised cloth and then follow round carefully with the sloping edge of a razor where diaphragm and surround meet, being

has been made to permit of the insertion of spacing washers so that the coil winding can be brought centrally within the gap.

The provision of centring is, of course, essential in so small a gap. Any form of attachment by paper spider effectively ties down the movement of the coil, and if loosely mounted is of little use. The centring adopted consists of a brass ring and baize pad so that the coil actually rides on the edge of the baize which fits into the centre of the coil former. This form of centring does not produce an increasing restriction on the movement with increase of amplitude. At the same time it allows the coil to take up a position in the gap as determined by the surround apart from the centring device. Leading-out wires are seccotined down to the sides of the diaphragm under strips of tissue paper some 1½ in. in length and then taken on to terminals carried in insulating bushes on the aluminium frame.

To ensure good results attention must be given to the circuit of the receiver, and experience shows that a single H.F. stage with either neutralised triode or screen-grid valve, transformer-coupled to an anode-bend detector and followed by a resistance-coupled L.F. stage, is about the best when using a good outside aerial. This circuit, with suitable values, is given. Such a set is a local-station receiver, and it will quickly be realised that good-quality reception cannot be obtained from distant stations if only for the reason that a sensitive set introduces background noises. Owing to the impedance of the loud speaker being somewhat low in value, the use of a pair of parallel-connected output

**Permanent Magnet Moving Coil Loud Speaker.**— valves gives an appreciable increase in volume. Two P.625 valves produce a sensitive output stage in view of the comparatively high amplification factor and the relatively low impedance. If the grids are fully loaded the power output of the pair of valves is nearly two watts when combined with the moving coil described, while with a single valve this output is more than halved.

To those accustomed to the use of a moving-coil loud speaker where the field excitation is derived from a rectifier this loud speaker is to be specially commended. Although the background ripple coming from a rectifier used to energise a field magnet may be practically inaudible, its removal makes a vast difference to the quality of reception, particularly as quite large 50-cycle

amplitudes may be built up without an appreciable sound resulting. Moving-coil loud speakers are, moreover, particularly responsive to these low frequencies, whereas a reed-driven cone invariably gives no response below 100 cycles. Tested over the frequency range with audio-oscillator and calibrated microphone using valve voltmeter as a means of measuring the amplitudes transmitted and received, the finished speaker reveals a characteristic as good as any other model, possessing, at the same time, the well-defined brilliancy only to be found in speakers of the moving coil type. The base response is as good at 40 cycles as at 200, while a falling off does not occur until a frequency of 6,000 is reached, which is a condition with all types of loud speakers and, incidentally, of the associated amplifier as well.

**AN OPTICAL PICK-UP.**

The drawing illustrates an ingenious method of converting the mechanical movements of a gramophone stylus into a fluctuating electrical current of corresponding value (patent No. 314,126). At the centre of the diaphragm C is a small spot of deposited silver, acting as a reflector to a beam of light projected from a lamp L. The lamp is mounted in the centre of a disc D carrying a series of light-sensitive cells G. The movements of the stylus S as it follows the track of the gramophone record vibrates the diaphragm C, and so varies the intensity

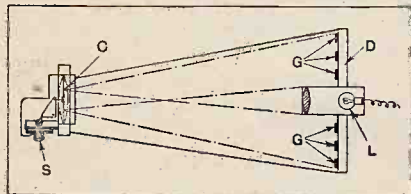

Converting the movements of a gramophone needle into fluctuating currents by means of a reflector and light-sensitive cell. (No. 314,126.)

of the light reflected back on to the cells G from the "silver spot" mirror, thus giving rise to corresponding current changes in the circuit of those cells. The component parts shown are all mounted on the tone arm.

o o o o

**INDIRECTLY HEATED VALVES.**

The sensitised cathode of a valve is energised by heat generated when the current from A.C. mains is applied to a condenser of which the cathode forms one plate (Patent No. 307,325). A highly refractory dielectric is used, such as zirconia, thoria, or silica. The sensitised cathode is in the form of a tube containing the dielectric, which contacts in turn with two semi-cylindrical metal plates to which the alternating mains voltage is applied. The arrangement in effect forms two condensers arranged in series, the external cathode being the common or central plate, so that it remains at a constant potential.

In another arrangement (Patent No. 307,326) the sensitised cathode is heated

**RECENT INVENTIONS OF WIRELESS INTEREST.**

by ionic bombardment set up across the gap between its inner surface and a central auxiliary electrode, the A.C. mains being directly connected across the two. The tubular cathode forms an electrostatic screen for the other electrodes.

o o o o

**SAFEGUARDING POWER OSCILLATORS.**

During normal operation the passage of grid current automatically maintains the grid of a transmitting valve at a safe negative bias. Should the valve cease to function, the negative grid charge tends to disappear, and if no precautions were taken this would in most cases cause the transmitter to burn out. In order to prevent such a contingency, the arrangement shown in the figure has recently been protected (Patent No. 308,085).

The ordinary grid condenser C and grid leak G L are supplemented by a

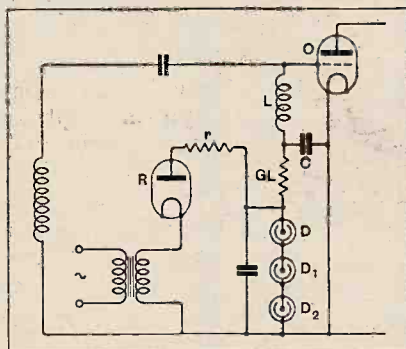

Maintaining a safe negative bias on a transmitting valve. (No. 308,085.)

choke L, and by one or more discharge tubes D, D<sub>1</sub>, D<sub>2</sub> designed to flash over at a voltage corresponding to the minimum "safe" grid potential of the

oscillator valve O. So long as the transmitter is in operation the correct working grid bias is maintained, any excess voltage escaping via the tubes D-D<sub>2</sub>. Should the valve cease working, so that the grid current stops, a rectifier valve R comes into action and provides sufficient negative grid bias to prevent any damage to the power valve.

o o o o

**A CONSTANT-COUPLING CIRCUIT.**

It is well known that in the ordinary type of back-coupled receiver the coupling factor tends automatically to increase for

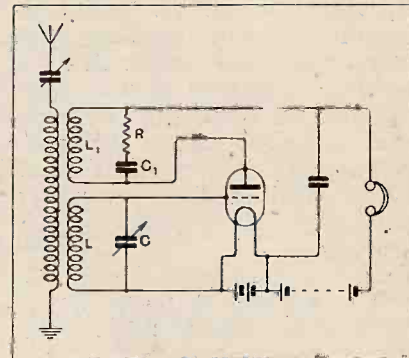

A constant reaction scheme with shunt circuit RC<sub>1</sub>. (No. 283,121.)

the shorter wavelengths, and to fall off for the longer waves, even if the spacing between the two coupling coils is maintained constant. A simple method of ensuring a constant degree of reaction in this type of receiver, even over a wide variation in tuning, is illustrated in the accompanying diagram (Patent No. 283,121).

The plate or reaction coil L<sub>1</sub> is shunted by a resistance R in series with a condenser C<sub>1</sub>. When the input circuit L C is tuned to a short-wave station, the shunt circuit R C<sub>1</sub> tends to bypass a larger proportion of the plate current than when the set is tuned to a long-wave station. The effective current flowing through the reaction coil L<sub>1</sub> is accordingly regulated so as to offset automatically any fluctuation in the degree of reaction as the tuning of the input circuit is altered.

# HIGH SELECTIVITY

## Hints on the Operation of Ganged Filter Circuits.

By W. T. COCKING.

(Concluded from page 35 of previous issue.)

IN Fig 6 are given full details of the medium-wave coils which have been used in experiments with the band-pass filter. While it is not claimed that they are the best which can be made, in practice they give extremely good results, and they have the merits of being both compact—an important point—and inexpensive. The inductance of each coil is 240 microhenrys, and the calculated H.F. resistance at 500 metres is 5 ohms; the tuning condenser should have a capacity of 0.00035 mfd.

### The Use of Trimming Condensers.

Each coil consists of 76 turns of No. 26 enamelled wire on a zin. diameter ebonite former. The formers are placed side by side in the position indicated, and as close as possible without the wire of one coil touching the former of the other; and in a position such that the distance between the end turn of one coil and the end turn of the other is exactly one inch. The value of coupling given by this arrangement has been found to be very satisfactory under all conditions; in some cases, however, a different value may give better results, and the effect of varying the coupling should certainly be tried. The two ends of the coils which come together in this method of mounting should, of course, be the low-potential (earthed) ends in order to reduce the possibility of capacity coupling.

In order to obtain the best results from the filter circuit it is essential that the two condensers in each filter be ganged; and, if this is done, there is no difficulty in ganging all the tuning condensers and making a single-control set. Ganging filter circuits is quite a different proposition from ganging the condensers of the usual cascade tuning circuits; the difficulties encountered are the same, but they are present in a very much smaller degree. Slight imperfections in the ganging do not make very much difference to the signal strength; instead, they make the tuning curve asymmetrical.

The greatest difficulty with ordinary tuning circuits lies in the aerial circuit, owing to the extra capacity thrown on to it by the aerial. Since the inductances of all the coils can very easily be made almost identical, the chief point in ganging the condensers of any set is to make the stray capacities across each tuned circuit the same. In the ordinary tuning arrangement this is difficult; each circuit usually has a very different minimum capacity. With filter circuits, on the other hand, the capacities are more evenly divided; indeed, sometimes the circuits are so nearly alike that almost perfect ganging can be achieved without the least trouble.

In certain cases, when volume control is carried out by means of a high-resistance potentiometer shunted across the secondary coil of the aerial filter, it is found that this circuit has the highest minimum capacity of any. Therefore, the capacity across every other coil must be increased; and this is best done by connecting in parallel with each tuning condenser a small adjustable condenser with a maximum capacity of about 50 mmfd. In any circuit this method of matching the minimum capacities may be adopted with good results. While it is easiest to connect an adjustable condenser in parallel with each tuning condenser, it is wasteful, for in every case there is at least one circuit in which an extra condenser is unnecessary. By adopting the

following procedure it is quite a simple matter to find out which circuits have low minimum capacities, and these are the only ones which need additional condensers: Tune in a station on about 500 metres by adjusting each section of the gang condenser separately. Tighten the couplings between them, and tune in a station on as short a wavelength as possible. Loosen the couplings, and, having noted the positions of the rotors, tune in the station to its best on each condenser separately. That circuit which requires the vanes of its tuning condenser to be enmeshed the *least* has the *highest* minimum capacity. Therefore, unless capacity can be

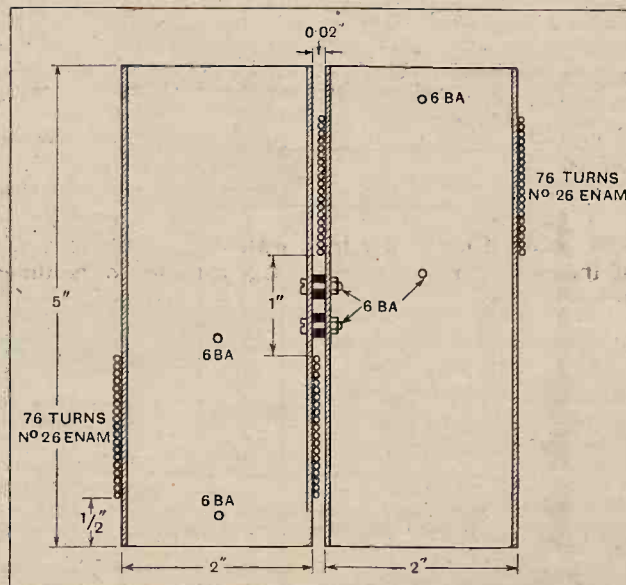

Fig. 6.—Dimensions of medium-wave coils which have proved successful in band pass filters. The inductance of each coil is 240 microhenrys.

**High Selectivity.**

removed from this circuit, all the other circuits must have a small condenser connected across them.

The operation of adjusting the capacities of these equalising condensers is quite simple. Set them all at minimum, and tune-in a station on the higher wavelengths (500 metres or so) by altering the positions of the rotors of the ganged condensers. Tighten up the couplings, and tune-in another station at the other end of the scale. This time do not loosen the coupling, but tune it in to its best by the small adjustable condensers. Now return to the longer wavelengths, and

aerial lead a series condenser for adjusting the minimum capacity of this circuit, and to include a different condenser for each waveband.

**Tuning Appears Flat with Band Pass Filter.**

All these equalising condensers are shown in the circuit of Fig. 7, and also the recommended method of switching for waveband changing. Reaction is shown, but can, of course, be omitted if desired. The reaction winding should consist of a few turns of thin wire wound at the earthed end of the secondary coil of the anode filter. Care should be taken to ensure that

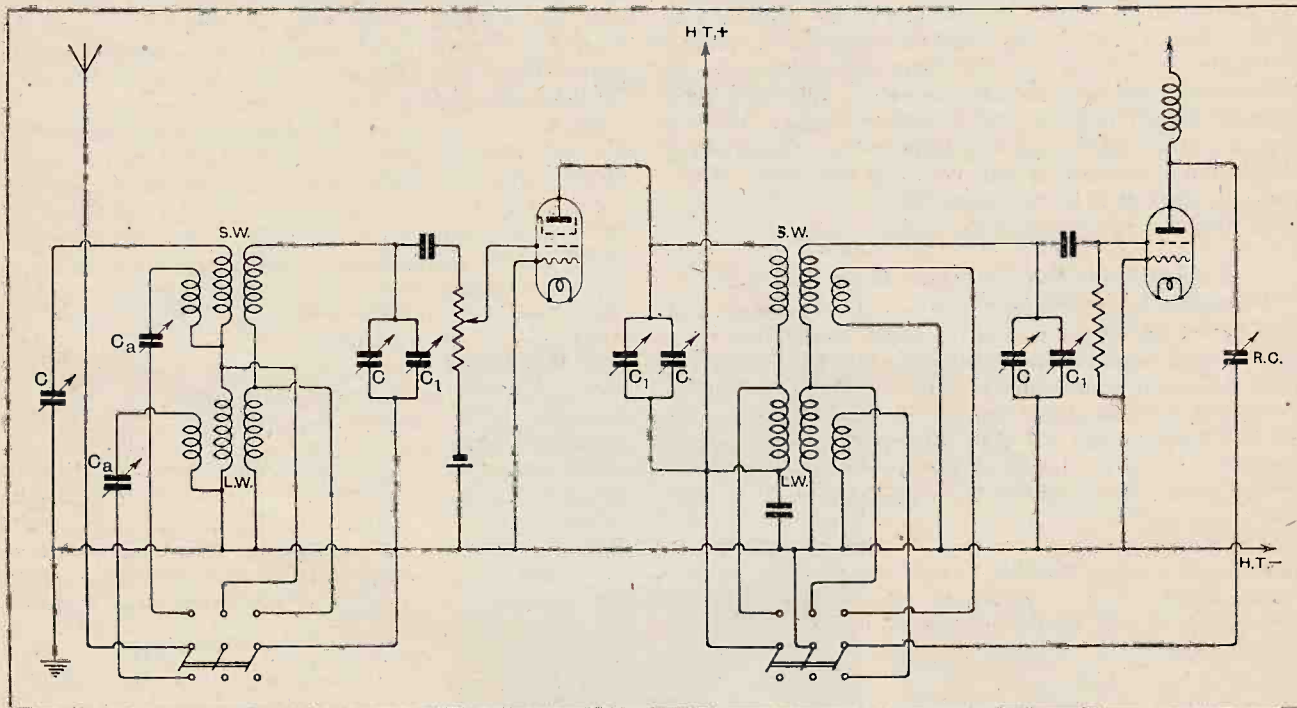

Fig. 7.—Circuit showing ganged filters, equalising condensers and a suggested method of waveband switching. C, ganged tuning condensers 0.00035 mfd.; C<sub>1</sub>, equalising condensers of 50 mmfd. and C<sub>a</sub> series aerial condensers.

again tune-in a station by altering the positions of the rotors. Tighten up the couplings and go back to the short wavelengths; tune-in a station on the adjustable condensers. Repeat this until no adjustments are necessary at any part of the scale. Usually it need only be done two or three times, but the oftener it is carried out the more perfect will the ganging be.

**The Series Aerial Condenser.**

The operation of ganging, if carried out on these lines, is by no means difficult, and, fortunately, once the condensers are properly ganged on the medium waveband, the ganging still holds good when the long-wave coils are switched in. This is provided that the long-wave coils all have the same inductance and self-capacity, which is usually the case. The only circuit likely to give trouble in this respect is the primary coil of the aerial filter. There will be no trouble if the aerial winding is suitable, but, unfortunately, this is different for every aerial; the best remedy is to include in the

it has a very low capacity to the tuned winding, otherwise either howling will result on the long waveband or the ganging of the last tuning condenser will be affected. This is not peculiar to the filter circuit, for it will occur with any circuit in which the reaction winding has a large capacity to the tuned grid circuit. On first operating a set employing band-pass filters the results may at first seem a little peculiar. As the single tuning control of a properly designed set is rotated a station will suddenly be heard, it will remain at constant strength over a condenser movement of several degrees, and then, as the control is further rotated, it will suddenly disappear. At first the tuning seems very flat, for when listening to a station quite a large movement of the dial produces little or no change in strength; but on each side of this band the station is suddenly cut out. The effect is due, of course, to the relatively flat-topped tuning curve obtained with these circuits. When trying out a new set it may be said that, after all the condensers are properly ganged, if a station can be tuned-in sharply

**High Selectivity.**

at one distinct setting of the dial, the coupling between the coils is too loose. On the other hand, if a station can be tuned-in sharply at two distinct settings of the dial the coupling is too tight. The coupling is correct when every station is audible over a small range of dial settings, but cuts off sharply outside that range. If it is noticed that the selectivity is less on one side of a station than it is on the other, it is a sign that the ganging is imperfect; the remedy is obvious.

The most satisfactory layout for a set using filters is undoubtedly one which is more or less symmetrical. The aerial circuit filter can be enclosed in a metal box, and the anode circuit filter in another box of the same dimensions. The layout of components in each box should be the same, in order to keep the stray capacities as far as possible alike in each circuit. The H.F. valve can very well be placed between the screening boxes. With a layout of this kind there is very little danger of instability, due to the anode circuit coils coupling with those of the grid circuit, but it is, of course, necessary to insert the usual decoupling devices in the battery leads.

**Remarkable Selectivity and Good Quality.**

The writer has found that a set built to the diagram of Fig. 7, with a layout on the lines indicated, gives very good results when followed by a two-stage L.F. amplifier (one R.C., one transformer). The coils used in the experiments were made to the specification given earlier in this article, and all four tuning condensers were ganged. As an indication of the selectivity obtainable, it may be said that with a P.M.12 valve for the H.F. and

a slight amount of reaction to counteract the detector damping, Toulouse can be received at full loud speaker strength without any jamming from Brookmans Park, although it is only about nine miles away. This could not be done with the same H.F. valve and two tuned circuits, at the same distance from the old London station. The separation of 2LO from Toulouse is only 58 kc., so this indicates a very high order of selectivity, and the valve used has both a lower A.C. resistance and a lower amplification factor than the A.C./S.G., for which the calculations were carried out.

On the long waveband it is not possible to receive Koenigswusterhausen without jamming from both 5XX and Radio-Paris. This is hardly surprising, since the separation is only 9 kc.; Radio-Paris, however, is quite clear of Daventry. The most noticeable improvement on the long waveband is the exceptionally good quality.

On both wavebands the amplification is noticeably less than with the same valve used with only two tuned circuits; this is inevitable, and represents the price which has to be paid for the high selectivity and good quality. The loss in amplification, however, is not serious, since by the use of the indirectly heated cathode screen-grid valve the amplification can be made the same as, or nearly equal to, that with a battery type valve with two tuned circuits. It may be said, therefore, that the filter circuit offers real advantages, not only for the improvement in quality but also in providing the high selectivity necessary under modern broadcasting conditions. In addition, a not inconsiderable advantage which it offers is the greater ease with which a really single-control receiver can be made.

**International Amateur Telephony.**

The Federal Radio Commission of U.S.A. has recently granted permission for the use of amateur telephony on 14,100 to 14,300 kc. (21.28 to 20.98 metres) by those holding extra first-class operators' licences or otherwise able to show special technical qualifications. The privilege, however, is in every case subject to the endorsement of the licence by the A.R.R.L., as the waveband is so restricted that the Supervisors of the League wish to limit the right to amateurs of demonstrated technical ability.

The Editor of our esteemed contemporary, *QST*, fears that the language barrier may prove a difficulty in transatlantic conversations, but he is, we think, unduly pessimistic when he writes: "Even when we talk to our cousins in the far-flung lands of the British Empire we cannot be too sure that our harsh American accent will convey much intelligence to the carefully attuned British tympanum. We may need a new international abbreviation to mean 'I hear you perfectly, but I haven't the slightest idea what you are talking about!'" We suspect that Mr. Warner is trying to "pull our legs" but hasten to assure him that, provided his followers do not indulge in too high flights of ultra-Americanism, we do not anticipate any great difficulty in understanding them.

**TRANSMITTERS' NOTES.****International Amateur Radio Union.**

It may be of use to our readers if we give a list of the various branches of the I.A.R.U. and the addresses to which communications may be sent. The Headquarters are the offices of the American Amateur Relay League, Hartford, Connecticut, where the business of the Canadian Section is also conducted. The affiliated societies are:—

*Gt. Britain.*—Incorporated Radio Society of Gt. Britain, 53, Victoria Street, London, S.W.1.

*Australia.*—Wireless Institute of Australia, 51, Castlereagh Street, Sydney, N.S.W.

*Belgium.*—Reseau Belge, 11, rue du Congrès, Brussels.

*Denmark.*—Experimenterende Danske Radioamatører, 5, Holmens Kanal, Copenhagen K.

*France.*—Reseau Emetteurs Français (R.E.F.), P.O. Box 11, Boulogne-Billancourt (Seine).

*Germany.*—Deutschen Amateur Sende und Empfang Dienstes (D.A.S.D.), Blumenthalstrasse 19, Berlin, W.57.

*Holland.*—Nederlandsche Vereeniging voor Internationaal Radioamateurisme (N.V.I.R.), P.O. Box 400, Rotterdam.

*Italy.*—Associazione Radiotecnica Italiana (A.R.I.), Viale Bianca Maria 24, Milan.

*New Zealand.*—New Zealand Assocn. of Radio Transmitters, P.O. Box 779, Auckland.

*Norway.*—Norwegian Radio Relay League, Voksenlia, Oslo.

*South Africa.*—South African Radio Relay League, P.O. Box 7023, Johannesburg.

*Spain.*—Asociacion E.A.R., Mejia Lequerica 4, Madrid.

o o o

**American Time Signals.**

A slight alteration in the code of signals from stations in U.S.A. will be made as soon as the transmitting clocks have been altered. The new code will consist, as before, of the transmission of a dot for each second of the five minutes preceding the actual time signal, omitting the last four dots (at the 56th, 57th, 58th, and 59th second) of the 55th to 58th minute, and the nine dots immediately before the dash which indicates the hour; the 29th dot in each minute is also omitted. The new feature will consist of the omission of the dots at the 51st second of the first minute of the signal, at the 52nd second of the second, the 53rd second of the third, and the 54th second of the fourth minute. The dots following these gaps indicate the number of minutes to go before the final dash.

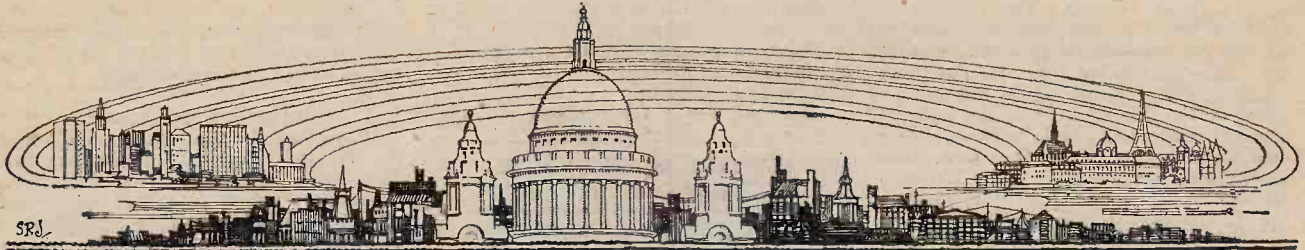

# CURRENT TOPICS

## Events of the Week in Brief Review.

### 1 IN 21.

Cambridge is believed to be the most "wireless" town in Britain, according to the local Post Office authorities. The number of wireless licences exceeds 13,000, representing one licence for about two-and-a-half inhabited houses.

○○○○

### SHORT-WAVE BED-TIME STORIES.

Even the tiny tots are discovering the value of short waves, to judge from an innovation at the Radio Experimental Station, Paris. This station now transmits a Children's Hour on 31.65 metres. It is intended specially for the benefit of children in the Colonies.

○○○○

### WIRELESS FOR WAR VETERANS.

The *Daily News*, which was instrumental in securing wireless for the principal London hospitals, completed another happy enterprise on Wednesday last, when Viscount Cowdray presented a wireless installation to the Chelsea Pensioners' Hospital, the cost having been borne by readers of the newspaper. The installation, on which nearly £700 has been spent, includes 576 points for headphones.

○○○○

### HAVE YOU TRIED IT?

"Sonorous perspective effects" are claimed by M. P. Hemardinquer, a French wireless amateur, in experiments he has conducted with two pick-ups and two identical gramophone records played simultaneously. By slightly retarding one record and carefully adjusting its volume, M. Hemardinquer states that a genuine stereoscopic effect is obtained, especially when two loud speakers are employed.

○○○○

### SHORT WAVES AND A SOLAR ECLIPSE.

General Ferrié, the chief of the French military wireless service, has just communicated to the Academy of Sciences the results of radio observations which he conducted in Indo-China in May last during the total eclipse of the sun.

During the period of totality there was a considerable diminution of signal strength on the short waves and 30 seconds elapsed between the direct signal and the receipt of the characteristic "echo." The General made no attempt to explain the delay, writes our Paris correspondent.

A 25

### LONG WAVES FROM ICELAND.

"Utvarpsstoed!" will be the password of Iceland's first broadcasting station, to be opened at Reykjavik in the early summer. The aerial power will be 16 kW. and the wavelength 1,200 metres.

○○○○

### A USE FOR "JUNK."

Most amateurs find it necessary to start a junk box within a few weeks of beginning their wireless career. Many of the components which make up these museums



**CHELSEA PENSIONERS' WIRELESS.** Through the enterprise of the *Daily News* a Marconiphone receiver with 576 headphone points has been installed at Chelsea Hospital. A unit system amplifier with eight valves is used. The photograph shows how the service is "laid on" to each cubicle.

are obsolete but perfectly sound, and it is with this fact in mind that the Stretford and District Radio Society has issued an appeal in connection with the Manchester Station Wireless for the Blind Fund. Members of the society feel confident that the nation's junk boxes will yield ample material to construct serviceable sets for the blind poor.

Wireless amateurs or others who wish

to contribute to this most practical effort are cordially invited to send their surplus apparatus, be it ever so old, to the Hon. Secretary, Manchester Station Wireless for the Blind Fund, Town Hall, Manchester, or to the Stretford and District Radio Society, 6, Derbyshire Lane, Stretford, Manchester.

○○○○

### I.E.E. ANNUAL DINNER.

The annual dinner of the Institution of Electrical Engineers will be held at the Hotel Cecil, Strand, W.C.2, on Thursday, February 6th, 1930, under the Presidency of Col. Sir Thomas F. Purves, O.B.E.

○○○○

### INDEX AND BINDING CASES.

The index for Volume XXV of *The Wireless World* is now ready, and copies are obtainable, price 3d. (post free 4d.), from the publishers, Dorset House, Tudor Street, London, E.C.4. Binding cases for the volume can also be supplied, together with the index, price 3s. 1d., post free.

○○○○

### RADIO TRAIN CONTROL.

The London and North-Eastern Railway has recently conducted experiments in the use of wireless for handling goods trains in shunting yards, the object being to provide a means of communication between the engine-driver and the operator in charge of the control tower from which shunting operations are directed.

The results, which are not yet published, are being considered by the Ministry of Transport, and are expected to be dealt with in an official report on various methods of automatic train control.

○○○○

### WAR IN THE ETHER.

In defiance of the cheerful theory that broadcasting makes for international amity comes a disturbing report from a Stockholm correspondent indicating a radio feud between Sweden and an unnamed "Central European country."

The message tells of the establishment of a special control station in the little town of Eskiltuna, in Central Sweden, with the object of overcoming interference to Swedish listeners from outside sources. "It has been found," says the report, "that a wireless transmitting station in a certain capital of a Central European country has not respected the International Radio Convention, which it had signed, but arbitrarily changed its wavelength, with the result that it conflicted



## Part XVII.—Parallel Tuned or Rejector Circuits.

By S. O. PEARSON, B.Sc., A.M.I.E.E.

(Continued from page 44 of previous issue.)

IN last week's issue a tuned circuit was considered where the inductance and capacity portions were connected truly in parallel so that the alternating voltage applied between the ends of the circuit was common to each branch. Under these conditions it was found that when the circuit was tuned to resonance with the frequency of the applied voltage and that once the oscillating current flowing round the closed loop had been built up to a steady R.M.S. value or constant amplitude, no current whatever was drawn from the source of supply.

The system was likened to a pendulum or weight-loaded spring in vacuo where all sources of energy loss had been eliminated. Once the mechanical oscillations are started they will continue indefinitely without diminution under conditions like this where there is no loss of energy. Similarly in the imaginary perfect tuned circuit the oscillations of current round the closed loop would theoretically persist with undiminished amplitude even after the closed circuit has been disconnected from the source of E.M.F. This obviously must be so as there is no means of escape for the stored energy. Oscillations of any kind, electrical or mechanical, which continue with undiminished amplitude are called undamped oscillations. If the oscillations are self-maintained, as explained above, they are called free oscillations and their frequency is called the *natural frequency* of the circuit (or mechanical system). In the case of undamped free oscillations the natural frequency is the same as the resonant

frequency of the circuit, being given by  $f = \frac{1}{2\pi\sqrt{LC}}$  cycles per second.

**The Effect of Resistance.**

Now in practice it is impossible to obtain any vibrating system, whether it be mechanical or electrical, which is absolutely free from energy loss. For instance, in the case of a pendulum, even if it is suspended in a vacuum, there are some small losses in the suspension spring when

the pendulum is in motion. The result is that as soon as the driving impulses are withdrawn the oscillations will begin to die away at a rate depending on the magnitude of the energy losses. If the pendulum is suspended in air at ordinary atmospheric pressure instead of in a vacuum the air resistance to the motion of the bob would have a considerable *damping* effect and the decay of oscillations would be very much more rapid. Where it is required to maintain the oscillations at a constant amplitude in spite of incidental losses, it is necessary to give the pendulum a small impulse once every swing to make good for the energy lost per swing. This is what is done by the driving mechanism of an ordinary clock.

Turning now to the electrical circuit, we find that the same conditions have to be fulfilled. The inductance coil  $L$  is bound to have some resistance and this is always far greater than that possessed by the condenser and connecting leads. For this reason we are justified in assuming that the whole of the resistance in the circuit is concentrated in the inductive branch. The actual circuit under consideration is shown in Fig. 1 (a), where  $L$  is the inductance of the coil in henrys and  $R$  is its resistance in ohms;  $C$  is the capacity of the condenser in farads.

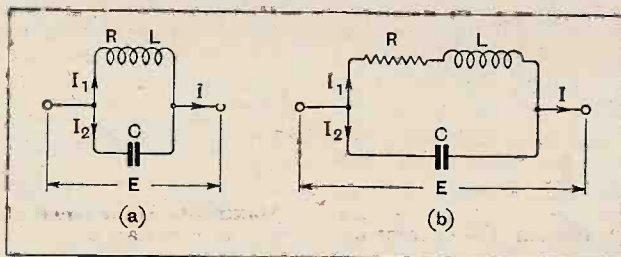

Fig. 1.—(a) Parallel circuit where resistance is present in the inductive coil. (b) Equivalent circuit.

Suppose that an alternating voltage whose R.M.S. value is  $E$  is applied to the ends of the circuit and that the circuit is tuned to resonance. As before, an oscillating current will traverse the closed loop, but heat will now be generated in the coil, due to its resistance. This means that the circuit is absorbing energy from the source of supply, and should this supply be cut off the oscillations would die away in the same manner that a clock pendulum will come to rest when the clock spring runs down. At the present time we are not concerned with the decay of oscillations but with the conditions obtaining when the oscillations are being maintained by the source of E.M.F. We require to know the general behaviour of the circuit when it is tuned to resonance with the frequency of an applied E.M.F. of constant amplitude.



Wireless Theory Simplified.—

We have already seen that a coil of inductance  $L$  and resistance  $R$  is electrically equivalent to a pure inductance  $L$  connected in series with a resistance  $R$ , and therefore the parallel circuit of Fig. 1 (a) is equivalent to the circuit of Fig. 1 (b), where the coil  $L$  has no resistance and the resistance  $R$  is non-inductive. Each branch then consists of a simple circuit whose principles have already been dealt with in this series. By combining the known laws of each in the proper manner we can determine the

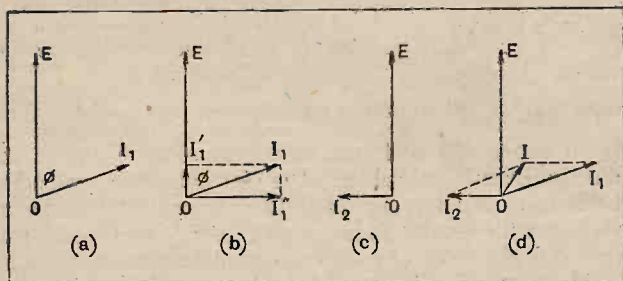

Fig. 2.—(a) and (b) vector diagrams for inductive branch of Fig. 1. (c) for condenser branch and (d) for the complete circuit.

resonant frequency of the circuit and find the impedance at any frequency or when tuned to resonance.

Currents in the Branch Circuits.

The current  $I_1$  taken by the coil is given by

$$I_1 = \frac{E}{Z} \text{ amperes.} \dots \dots \dots (1)$$

where  $Z = \sqrt{R^2 + (2\pi fL)^2}$  ohms is the impedance of the coil. This current lags behind the applied voltage  $E$  by an angle  $\phi$  where  $\cos\phi = \frac{R}{Z}$  as explained on page 523 (November 26th issue) and the simple vector diagram showing the phase difference between the current and voltage for the upper branch of the circuit is given in Fig. 2 (a).

The current  $I_1$  in the inductive branch can be considered as being the resultant of two component currents,  $I'_1$  in phase with the voltage, and  $I''_1$  lagging behind the voltage by  $90^\circ$ . This idea is clearly shown by Fig. 2 (b), from which it is easy to see that

$$I'_1 = I_1 \cos \phi \text{ and } I''_1 = I_1 \sin \phi,$$

and from the impedance triangle of the inductive coil, shown in Fig. 3, we see that  $\cos \phi = \frac{R}{Z}$  and  $\sin \phi = \frac{X}{Z}$ .

Referring now to the condenser branch, the current in it is given by  $I_2 = \frac{E}{X_c}$  amperes. . . . . (2)

where  $X_c = \frac{1}{2\pi fC}$  is the reactance of the condenser. This current  $I_2$  leads the voltage  $E$  by  $90^\circ$  as shown in Fig. 2 (c).

To find the current taken by the combined circuit, i.e., the current drawn from the supply, we must add by the vector method the two currents  $I_1$  and  $I_2$  in the respective branches. This is done by drawing the two current vectors  $OI_1$  and  $OI_2$  from a common origin  $O$  in their correct phase positions as shown in Fig. 2 (d). We see at once that the two currents  $I_1$  and  $I_2$  are not opposite in

phase as they were in the case of the circuit without resistance, and the resultant therefore cannot be found by simple subtraction. The resultant current is given by  $OI$ , the diagonal of the parallelogram formed with  $OI_1$  and  $OI_2$  as adjacent sides. The impedance of the complete circuit is simply equal to the ratio of voltage to current. The formula giving the current at any frequency is rather complicated, but fortunately we can deal with the circuit from a graphical aspect to get a clear conception of its general behaviour.

Minimum Current at Resonance.

As the frequency is raised the current  $I_1$  in the coil decreases, whilst the current  $I_2$  in the condenser branch increases; but if on the other hand the frequency is kept constant and the capacity of the condenser is varied, only the current  $I_2$  will change. This simplifies matters a great deal and accordingly let us suppose that the capacity  $C$  is varied over a wide range, everything else being fixed. The current  $I_2$  is directly proportional to the capacity and therefore the resultant current  $I$  will vary both in phase and magnitude as the capacity is changed. Let  $OA$ ,  $OB$ ,  $OC$ ,  $OD$  and  $OF$  be several values of condenser current represented as vectors in Fig. 4 (a) corresponding to different values of the capacity,  $OI_1$  being the fixed current in the inductive coil. The broken line vectors 1, 2, 3, 4 and 5 in the diagram show the resultant currents for the respective capacity values. Of these, No. 3 is in phase with the voltage and is obviously the shortest.

It is thus clear that there is one particular value of capacity which will make the total current a minimum, and this minimum current is exactly in phase with the voltage. When this happens the circuit is tuned to complete resonance with the applied frequency, because all components of current at right angles to the voltage balance out and the circuit as a whole behaves as though it were a pure resistance. The vector diagram showing the conditions for complete resonance is given in Fig. 4 (b).

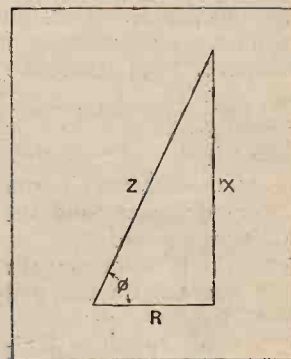

Fig. 3.—Impedance triangle for inductive branch of Fig. 1.  $X = 2\pi fL$  and  $Z = \sqrt{R^2 + X^2}$

Maximum Impedance at Resonance.

Since the current is smallest at the frequency of resonance it follows that the impedance of the circuit must be a maximum when tuned to resonance. These conditions are exactly the reverse of those obtaining in a series circuit, where the impedance was found to be a minimum at the resonant frequency. And so the parallel circuit has the property of partially rejecting or refusing to pass currents whose frequencies lie within a band near the resonant frequency whilst allowing currents at frequencies outside this band to pass comparatively freely. For this reason the parallel tuned circuit is very often called a "rejector circuit," especially when used in a filter circuit designed to cut out a powerful local station.

with that of Sweden. The country in question has been officially requested to change its wavelength to conform with the convention, but, so far, without result. The Swedish radio authorities, owing to the lack of space in the maze of ethereal traffic, are unable to change their own wavelength. *They have now, however, given the Swedish radio listeners the comforting assurance that as soon as the latest and most powerful of the Swedish sending stations is completed it will be strong enough to get the better of the disturber of the peace, who will then be forced to surrender to the ultimatum of the victor and adopt the wavelength once allotted to it.*

A similar situation recently arose between Great Britain and Spain, but the question was amicably settled through the mediation of the British Post Office. It seems a pity that Sweden cannot adopt the same peaceful tactics.

#### JAPANESE PROGRAMME DILEMMA.

Japan's broadcasting system, which was inaugurated in 1926, has considerably developed during the past three years. To-day (writes a correspondent) it is run by four separate organisations, which together control over ten transmitters. The principal stations are installed at Hiroshima, Osaka, Sapporo, Sendai and Tokio, with relays at Daiyen, Seoul (in Korea), Nagoya, and on the Island of Formosa. Of these, six are transmitters capable of developing an energy of over ten kilowatts. All studios except one are interconnected by pupinised cable with the capital and main transmitter, the exception being that of Hokkaido, which takes its programme by wireless link.

The system is now providing a regular service to nearly 700,000 listeners, and the

licence tax fee has recently been reduced to 1 yen monthly.

The broadcasting organisers experience great difficulty in making up programmes capable of entertaining the various classes of listeners, for in Japan, more, perhaps,

are perpetually confronted with the problem of pleasing everybody and have therefore to provide two distinct programmes in the course of a transmission.

o o o o

#### WARNING TO WIVES.

Discomfort for the "gude wife" when the Scottish Regional broadcasting station opens is predicted by a Northern newspaper, which says that wives may expect a "shocking" time as a result of electrical energy in the ether. "They may find it difficult to pick up metal kitchen utensils without getting mysterious electric shocks," explains the writer. However, he concludes with the comforting assurance that these shocks are not sufficiently strong to do any harm and are only received in certain circumstances. He might have added that the necessary circumstances include living under the aerial and fairly near to the transformers.

o o o o

#### FIRE.

We are asked to state that there is no truth in recent reports that the factory of Messrs. A. C. Cossor, Ltd. (manufacturers of Cossor valves and wireless apparatus), had been burnt out. The fire in question took place at the works of Messrs. A. C. Cossor and Son, scientific instrument makers. There is no connection between the two firms.

#### FORTHCOMING EVENTS.

##### WEDNESDAY, JANUARY 15th.

*Institution of Electrical Engineers, Wireless Section.*—At 6 p.m. At the Institution, Savoy Place, W.C.2. Lecture: "A Method of Measuring the Overall Performance of Radio Receivers."

*Golders Green and Hendon Radio Society.*—At 8.15 p.m. At the Club House, Willifield Way, N.W.11. Ordinary meeting.

*Edinburgh and District Radio Society.*—At 8 p.m. At 16, Royal Terrace. Demonstration of Gramophone Reproduction by Mr. J. L. Minto.

*Muswell Hill and District Radio Society.*—At 8 p.m. At Tollington School, Tetherdown, N.10. Lecture and Demonstration: "The Neurosonic Six-valve Short-wave Receiver," by Mr. Alford, of The Igran Electric Co., Ltd.

*North Middlesex Radio Society.*—At 8 p.m. At St. Paul's Institute, N.21. Lecture: "The Power Valve," by Mr. G. Parr, of the Edison Swan Electric Co., Ltd.

##### THURSDAY, JANUARY 16th.

*Ifjord and District Radio Society.*—At the Wesleyan Institute, High Road, Ifjord. Demonstration by Philips Radio, Ltd.

##### MONDAY, JANUARY 20th.

*Newcastle-upon-Tyne Radio Society.*—At 7.30 p.m. In the English Lecture Room, Armstrong College. Lecture: "A Further Step Towards Common Sense Radio Reception," by Mr. S. Burns, M.I.E.E., M.Inst.M.E.

*Croydon Wireless and Physical Society.*—Lecture: "Selectivity," by Mr. A. J. Webb.

than in any other country, the older generation steadfastly upholds tradition. On the other hand, the modern element, represented by the younger generation, demands entertainment on European and American lines. The programme builders

#### BOOKS RECEIVED.

*Le Strobodine*, by L. Chrétien. A booklet giving the theory and practical construction of this popular French receiver. Pp. 78, with 45 illustrations and diagrams. Published by "La T.S.F. Moderne," Paris. Price Fcs. 10.

o o o o

*Le T.S.F.M.*, 1930, by L. G. Veysière. The design and construction of a modern superheterodyne receiver, with explanation of the nature and function of each component. Pp. 75, with 57 illustrations and diagrams. Published by "La T.S.F. Moderne," Paris. Price Fcs. 10.

o o o o

*Wireless and Gramophone Trader Year Book and Diary*, 1930.—The sixth edition of this most useful book of reference includes all the features which have proved so valuable in the past carefully revised, enlarged, and brought up to date. The Directory Section contains a full alphabetical list of Manufacturers, Agents, Associations, and Publications connected with the wireless and gramophone trades in Great Britain; Wireless and Gramophone Factors; a Classified List of the Manufacturers of Wireless and Gramophone Sets and Accessories, and a list of Proprietary Names of various apparatus. The General Information, Trade Information, Technical Data, and Gramophone Sections have also been considerably enlarged. Manufacturers and traders will especially welcome the abstract of the new provisions of the Marconi Licence. Published by the Trader Publishing Co., Ltd., Salisbury Square, E.C.4. Price 5s. 6d. post free, or at a reduced rate to subscribers to the "Trader" journals.

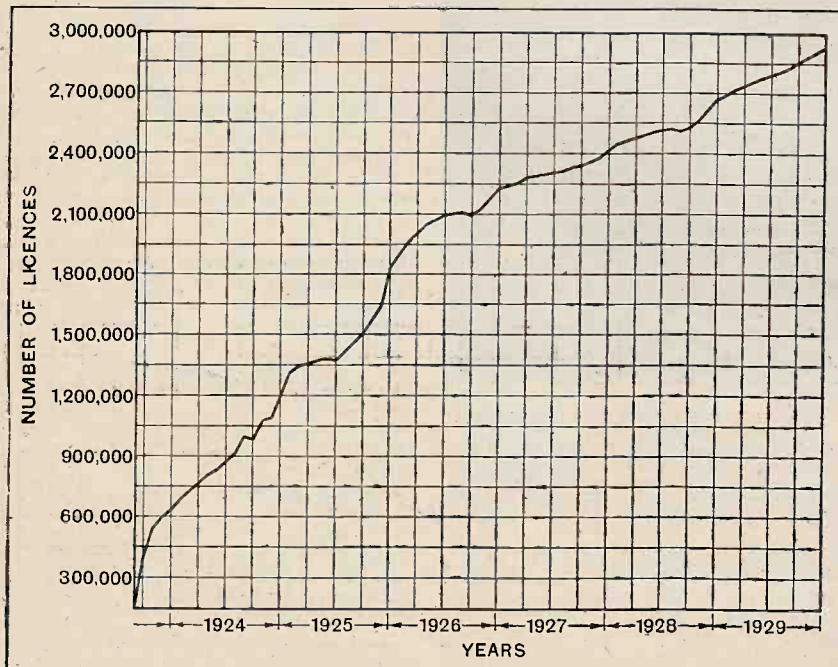

THE BRITISH RECEIVING LICENCE CURVE. A graphical demonstration of the steadily increasing popularity of broadcasting. It will be noticed that the only appreciable decline occurred in the autumn of 1924. Will Radio Week complete the third million?

# An Aid for the Deaf

## The Construction of an Electrostatic Earpiece.

BY OUR  
GERMAN CORRESPONDENT.

**D**ESPITE the fact that many deaf people suffer agonies from being shouted at, practically all the existing electrical devices for the deaf are based on the principle of amplifying the sound to an extent unbearable to the normal ear.

To find a better means of influencing the inner organs of the ear, Dr. Gustav Eichhorn, of Zurich, has experimented for a number of years with a system which now appears in commercial form under the name of the "Radiophone." From the results obtained with this interesting instrument the inventor concludes that the flesh surrounding the ear is forced, by an electrostatic effect, to set up oscillations, which are not transferred to the skin of the ear drum, but direct to the organs of hearing.

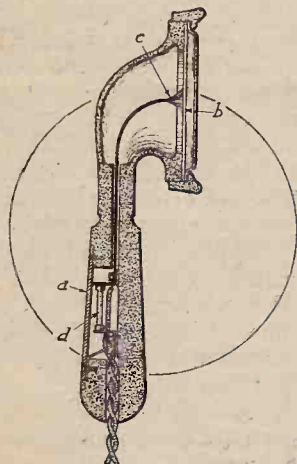

Internal construction showing (a) Contacting plate. (b) Diaphragm. (c) Flexible lead. (d) Shunt resistance.

The distinguishing feature of the "Radiophone" is the inclusion of the listener himself in the plate-circuit of the L.F. valve of the wireless receiver. This is done by connecting the user through the hand holding the device (a) to the positive output terminal of the receiver, while the negative terminal is connected with stranded flex to a thin metallic plate (b) in a special sound-box placed against the ear. The sound-box is provided with a movable cover of cardboard, thin wood or similar non-conducting material, upon which the metallic plate is fastened on the inner side. The individual wires (c) of the flex lead are splayed over the surface of the metal sheet, and upon this connection a second sheet of metal foil is pressed tight.

It is common knowledge that in the telephone-circuit of a wireless receiver we have to deal with the direct current in the plate-circuit and the modulated alternating currents superimposed thereon. Dr. Eichhorn's experiments have shown that the sensitivity of his

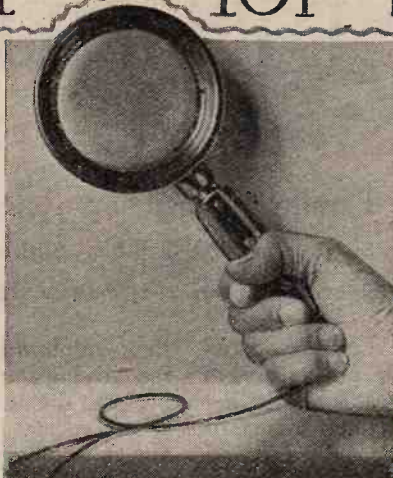

instrument is essentially dependent upon the voltage on the plate, which must be proportionately greater when the alternating voltage is reduced. In all tests in which the superimposed voltage was low audibility increased rapidly with increases in plate voltage up to between 120 and 150 volts.

Used with a typical three-valve set, the "Radiophone" gives signals which are nearly as powerful as those with the usual headphones. If the hand is removed from the metallic surface on the handle no signals can be heard; this is also the case when the polarity is reversed by connecting the sound-box to the positive terminal of the receiver. From this the inventor deduces that the small tin-foil sheet is set in oscillation by the low-frequency currents, the speech and music being amplified to some extent by the sound-box.

In the lower recess in the handle a metal strip making contact with the hand is connected to the positive lead to the receiver. The negative lead is taken through the metal disc in the sound-box, while across the two leads in the lower recess is a resistance of about 100,000 ohms (d). This resistance has been found to eliminate fluctuations in sound intensity due to the fact that the polarising potential derived from the valve circuit is not constant. The optimum plate potential depends upon the type of valve used, one working with an anode voltage of between 70 and 100 being recommended.

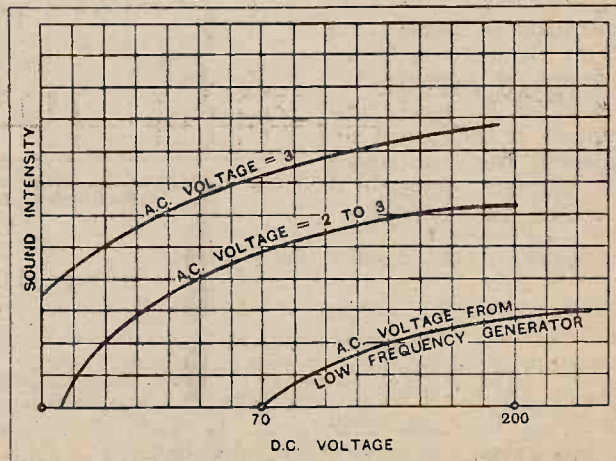

Curves showing the relation between sound intensity and superimposed D.C. voltage for various A.C. potentials.

**Wireless Theory Simplified.—**

A parallel circuit is used for tuning purposes where it forms part of a circuit which normally has a very high resistance, as, for instance, in the anode circuit of a valve. The details of such a circuit will be discussed later, but it can be mentioned here that the conditions for maximum selectivity are practically the same as those relating to the series tuned circuit, namely, low coil resistance and high ratio of inductance to capacity.

The vector diagram of Fig. 4 (b) enables us to find the impedance of the circuit at the resonant frequency and

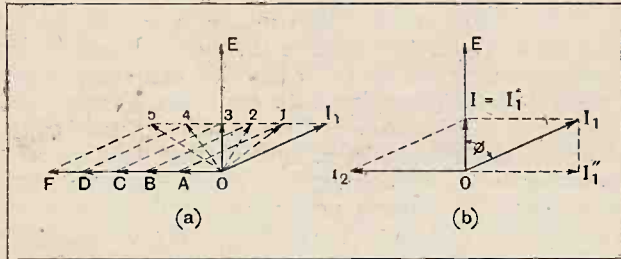

Fig. 4.—(a) Vector diagram showing that the resultant current is least when in phase with the voltage. (b) Vector diagram for parallel circuit tuned to resonance.

the value of the resonant frequency itself. The resultant current I is in phase with the voltage, showing that I<sub>2</sub> and I'<sub>1</sub> balance out. Hence I<sub>2</sub> = I'<sub>1</sub>, from which the exact resonant frequency can be found. But in practice the resistance of the coil is so low compared with its reactance at the high frequencies used that the angle of lag, φ, is nearly equal to 90° and therefore I'<sub>1</sub> is almost equal to I<sub>1</sub> and a negligibly small error will be introduced if we assume I<sub>2</sub> = I<sub>1</sub>. When this assumption is made, the conditions are the same as those for the circuit without resistance, and therefore the resonant frequency is  $f = \frac{I}{2\pi\sqrt{LC}}$  cycles per second approximately (see appendix).

At the resonant frequency the circuit behaves like a pure resistance, and the impedance under these conditions is called the "the dynamic resistance" of the circuit. It is the actual resistance offered to currents at the resonant frequency, being thus an extremely important quantity.

**Finding the Dynamic Resistance.**

The value of the dynamic resistance is given by the ratio of voltage to current when the circuit is tuned to resonance. Denoting the dynamic resistance by R<sub>D</sub> we have  $R_D = \frac{E}{I}$  ohms, where I is the current taken by the complete circuit when tuned to resonance. But from the vector diagram of Fig. 4 (b) we see that

$$I = I_1 \cos \phi = \frac{E}{Z} \times \frac{R}{Z} = E \times \frac{R}{Z^2}$$

Hence dividing the voltage E by this current we get for the dynamic resistance  $R_D = \frac{Z^2}{R}$  ohms, where Z is the impedance of the coil.

Now, since in practice the resistance R of the coil is small compared with its reactance 2πfL, the impedance of the coil is very nearly equal to its reactance and we may therefore write 2πfL in place of Z to give an approximate result. Hence  $R_D = \frac{(2\pi fL)^2}{R}$  ohms approximately. But at resonance the frequency is very nearly  $f = \frac{I}{2\pi\sqrt{LC}}$ , and substituting this value of f in the last

equation we get dynamic resistance  $R_D = \frac{L}{CR}$  ohms. This is an expression of fundamental importance and is not an approximation but an exact formula (see appendix) in spite of our having made two approximations in arriving at the result. It happens that the two slight errors introduced are of opposite sign and balance out.

The conclusion is that the dynamic resistance or maximum impedance is actually *inversely* proportional to the ohmic resistance of the coil, and proportional to the ratio of inductance to capacity. If the resistance of the coil were zero the dynamic resistance of the circuit would be infinitely great and no current would enter or leave it, as we have already discovered.

**Appendix.**

I. Resonant frequency of Parallel Circuit.

From Fig. 4 (b)  $I_2 = I_1 \sin \phi$ ,  
 $\omega CE = \frac{E}{Z} \times \frac{\omega L}{R}$ , where  $\omega = 2\pi f$ ,

or  $C = \frac{L}{Z^2}$

Whence  $Z^2 = \frac{L}{C}$  ..... (1)

$R^2 + (\omega L)^2 = \frac{L}{C}$

or  $\omega = \sqrt{\frac{1}{LC} - \frac{R^2}{L^2}}$

∴ Resonant frequency  $f = \frac{I}{2\pi\sqrt{\frac{L}{C} - L^2}}$

II. Dynamic Resistance.

$$R_D = \frac{E}{I} = \frac{E}{I_1 \cos \phi} = \frac{E}{\frac{E}{Z} \times \frac{R}{Z}} = \frac{Z^2}{R}$$

But from (1) above  $Z^2 = \frac{L}{C}$

∴  $R_D = \frac{L}{CR}$  ohms.

(To be continued.)

**RADIO WEEK.**

In a few days' time the jury, i.e. the non-listeners, will retire to consider their verdict on the question, "Is Broadcasting Worth While?" Listeners can help to secure a favourable answer by letting their non-wireless friends listen to good reproduction of the B.B.C.'s special programmes, remembering that a bigger listening public means a better broadcasting service.

# LABORATORY TESTS.

A Review of Manufacturers' Recent Products.

## MARCONIPHONE MOVING COIL LOUD SPEAKER UNITS.

These units are now being supplied uncased to provide the home constructor with a model suitable for building into a piece of furniture, or for incorporating in radio-gramophone cabinets.

Two types are available: one with a 10-ohm field winding for use with 6-10 volt accumulators, and the other with a 3,000-ohm field coil intended for mains excitation. The last mentioned would be used on D.C. mains direct, but in conjunction with a rectifier unit for A.C. supplies. Both models are sensibly the same, the only difference being in the method of exciting the field coil. The chassis submitted for test was of the low-voltage type.



Marconiphone moving coil loud speaker unit.

Before being given a practical test it was fitted to a large baffle board, 3ft. square, with a hole of suitable size cut in its centre. Measurements showed that when energised from a 6-volt accumulator a current of 0.57 amp. was required. With a 10-volt battery the energising current was a little under 1 amp. Although the sensitivity, when used with a 6-volt accumulator, is noticeably lower than that of a mains excited model of the same make, it is ample for all practical needs, the volume being in excess of that required to fill a room of average size, using a good super-power output valve with a generous high tension supply.

These tests were made with a receiver designed to have a straight line amplifier characteristic. The very low notes in the bass, although not overpowering, were reproduced with full-throated volume. The response of the middle register and the higher frequencies was good, and a slightly better balance of output was obtained by the employment of a baffle of smaller size. As the unit will, in general, be fitted in a cabinet, this is perhaps a minor point. The reproduc-

tion of music and speech is crisp and clear.

These models are fitted with cone diaphragms 7in. in diameter, which are pressed from stout fibrous material, the centring device being integral with the cone and provided with a stepped ring on which fixes the speech coil. An input transformer is mounted on top of the chassis. A supple surround of soft velvet supports the periphery of the cone.

The makers are the Marconiphone Co., Ltd., 210-212, Tottenham Court Road, London, W.1, and the prices are as follows:—6-10 volt model, £4 10s., and D.C. mains model, £5. A rectifier unit for A.C. mains use costs £4 15s., including valve and royalty.

o o o o

## EELEX INSULATED H.T. CONNECTORS.

The new range of insulated plugs and sockets introduced by Messrs. J. J. Eastick and Sons, 118, Bunhill Row, London, E.C.1, have been designed especially for use in connection with battery eliminators and mains-operated receivers.

Greater care is required in handling the H.T. leads, and consequently the insulation on the plugs and sockets has been very carefully thought out. All metal parts hitherto exposed are fully protected, and the risk of shock due to accidental contact with live leads has been reduced to a minimum. Provision is made also to grip the braided covering on "flex" leads, thereby giving a tidy appearance to the connecting leads.

These "All Shrouded" plugs and sockets are offered at 6d. per pair.

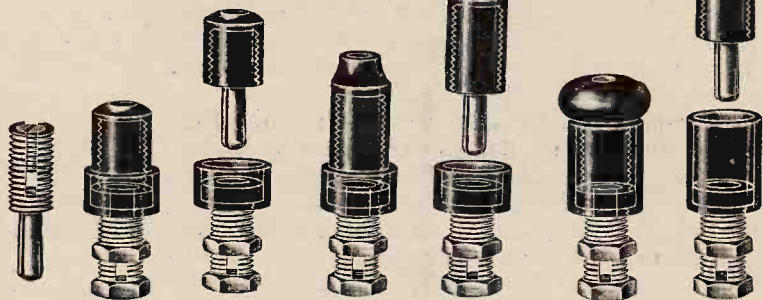

Eelex "All-Shrouded" plugs and sockets for use in mains equipment.

## LOTUS JACKS AND JACK SWITCHES.

The body of these jacks consists of a bakelite moulding on which is mounted genuine nickel silver springs each tipped with a pure silver contact. A faulty connection should be very rare indeed. Hitherto contact with the springs was

made by soldering the leads on to tags, but in the latest version the soldering tags have given way to small terminals carried on fantail extension lugs. A single-hole fixing bush is provided.

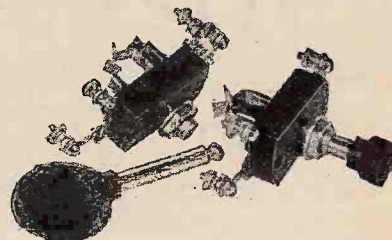

"Lotus" radio jack, jack plug and jack switch. Terminals are now fitted to all jacks and switches.

Five types are available, ranging from a single circuit open jack to a single circuit open double-filament control-type. The price is according to type, the cheapest being 2s. and the last mentioned 3s.

These jacks demand a jack plug with a longer stem than is usually fitted so that it is necessary to employ the "Lotus" version. This costs 2s. Loud speaker tags or "flex" can be gripped firmly by the aid of the special cam-lock fitted. The "stem" and the "ball" connections are clearly marked on the bakelite cover.

A range of five jack type push-pull switches from a single-pole make-and-break to a double-pole double-throw is now available, the general design following

closely that of the jacks. The same quality material is used throughout. Single-hole fixing is provided and the bush is insulated from all contact springs. These switches cost 2s. 9d. for the single type and 4s. for the D.P.D.T. style. The prices of other types are S.P.D.T. 3s. 3d. and D.P.S.T. 3s. 6d.

# Southend Wireless Show

## Society's Record Success.



A WIRELESS festival, to the fitting accompaniment of open-air and indoor loud speaker reproduction, was held at Southend on Saturday, January 4th, when the Southend and District Radio Society attracted thousands of visitors to their Sixth Annual Radio Exhibition, held at the Boys' High School, Victoria Circus. The occasion was a triumph for amateurs and professionals alike, and their joint efforts resulted in a contribution of at least £70 to the Victoria Hospital, Wireless Maintenance Fund.

Several magnetic influences were at work. In the first place, many enthusiasts were drawn to the competition stands, on which were displayed some excellent examples of amateur craftsmanship. The casual passer-by was also attracted by the compelling invitation of a battery of loud speakers facing Victoria Circus, these being erected and operated by Messrs. S. H. Davis and Son, of Westcliff. And in the Exhibition Hall itself Mr. F. H. Haynes, Assistant Editor of *The Wireless World*, provided a continuous demonstration of quality reproduction, with loud speaker "points" on each stand. The set employed consisted of the Schools Demonstration Receiver, followed by six independent output stages each fitted with choke condensers and two P 625 valves.

An admirable feature of the competitions was the introduction of a new method of classification enabling entrants every chance to succeed having regard to their opportunities and qualifications. Three classes of competition were instituted—A, B, and C—the first for *bona fide* amateur members of the Society, the second for other members, and the third for *bona fide* amateurs who were non-members. The scheme worked well.

Through the generosity of the trade, prizes were offered for a variety of home-made apparatus, and this formed the basis of the amateur side of the Exhibition. The apparatus submitted included portables, short-wave receivers, one- to three-valve and multi-valve receivers, loud speakers, battery eliminators, wavemeters and wavetraps, receiving set cabinets, and various mechanical and non-mechanical units. Much careful and

painstaking work was indicated, and the standard of craftsmanship increased the difficulties of the judges, Mr. F. H. Haynes, Mr. H. B. Dent, and Mr. H. L. Lobb.

The list of prize-winners is as follows:—

	Class.	Prize.	
Complete Set by High School Boy	1st	Mr. C. Stockell.	
	2nd	Mr. R. Kramer.	
	Cons.	Mr. J. Hill.	
Portable Sets .. .. .	A	—	No Entries.
	B	1st	Mr. W. A. Webb.
	C	—	No Entries.
Short Wave Receivers .. .. .	A	1st	Mr. E. W. Lockhart.
	B	1st	Mr. B. Costin.
	C	—	No Entries.
1 to 3 Valve Receivers .. .. .	A	1st	Mr. H. A. Clinton.
		2nd	Mr. E. T. Wiseman.
	B	—	No Award.
4 or more Valve Receivers .. .. .	C	—	No Entries.
	A	1st	Mr. W. J. Fletcher.
		2nd	Mr. H. R. Ireland.
Loud Speakers .. .. .	B	—	No Award.
	C	Cons.	Mr. S. R. Wilkins.
	A	Special	Mr. H. R. Ireland.
Battery Eliminators .. .. .			Mr. W. J. Fletcher.
	B	—	No Entries.
	C	Special	Mr. D. J. Lewis.
Wavemeters and Wavetraps .. .. .			Mr. M. J. Anthony.
	A	1st	Mr. P. Green.
	B	—	No Award.
Receiving-set Cabinets .. .. .	C	—	No Entries.
	A	1st	Mr. E. W. Lockhart.
		2nd	Mr. H. R. Ireland.
Various Mechanical Units .. .. .			Mr. A. E. Atwood.
	B	—	No Entries.
	C	—	No Entries.
Various Non-mechanical Units .. .. .	A	—	" "
	B	1st	Mr. A. R. Knipe.
	C	—	No Entries.
	A	1st	Mr. T. Holbeche.
		2nd	Mr. P. Green.
	B	1st	Mr. A. R. Knipe.
	2nd	Mr. A. C. Horsnell.	
	C	1st	Mr. W. B. Briggs.

**Southend Wireless Show.—**

Three sets, not for competition, were exhibited by the chairman, Mr. H. H. Burrows. One of these was an imposing six-valve instrument having two screen-grid H.F. stages, detector, and two stages of L.F., the last consisting of two power valves in parallel. The total value of the components alone was estimated at £25. The set was given in connection with a shilling competition in aid of the Hospital Wireless Fund.

Interest in amateur television was demonstrated by the curiosity aroused in Mr. A. Knipe's experimental television receivers, in which considerable ingenuity was displayed both in the synchronising gear and the method of marking out and constructing the disc. For his collective exhibit of television gear and a carbon

microphone with control units, Mr. Knipe was awarded the Pocock Silver Championship Cup, presented by the Editor of *The Wireless World* for annual award for the entry of most outstanding constructive merit.

The total number of entries in the amateur section was fifty-four, and the value of the prizes distributed was £45.

The trade exhibitors included Messrs. S. H. Davis and Son (organisers of the outdoor loud speaker demonstrator), J. Bridge and Son, T. Davis, F. Jeffery, E. K. Cole, Ltd., and H. C. Revell.

The Exhibition was open for eleven hours—from 11 a.m. to 10 p.m.—and during this time there were no fewer than 4,684 visitors. Is this a record for a wireless society show?

## CORRESPONDENCE.

The Editor does not hold himself responsible for the opinions of his correspondents.

Correspondence should be addressed to the Editor, "The Wireless World," Dorset House, Tudor Street, E.C.4, and must be accompanied by the writer's name and address.

**B.B.C. TRANSMISSIONS.**

Sir,—Much has been written recently about the effect of land lines on the quality of B.B.C. transmissions, and the following figures relative to the London-Bournemouth land line may be of interest.

The attenuation factor per 50 miles of land line is approximately 1 ounce of suet pudding in the mouth of the silvery-voiced announcer. It is regretted that no figures relative to orchestral transmissions can be given as none have been definitely identified as such.

C. E. WOOD.  
Parkstone, Dorset.

Sir,—Whatever the faults of land-line transmissions may be, surely Mr. Jas. Hudson, of Manchester, does not mean that the output from 2ZY's aerial is a good sample of perfection, even from the fine new studio, or otherwise. A more "tin-canny" output is not to be heard from any station in Europe.

A. GREGSON.  
Bolton.

**THE PROGRAMME DIFFICULTY.**

Sir,—The article concerning a Low-power Synchronised Transmission Scheme, by Major Humphry MacCallum, in your issue of December 25th, provided food for much thought. The outcome is that the views expressed are certainly worthy of more than passing attention. Eight out of ten people with whom I come into contact appear to be dissatisfied with the general run of programmes, whilst agreeing that the whole business of programme "building" is something of a problem. The eight, including myself, have not been clever enough to formulate a really practicable scheme. The one suggested has great possibilities and appears to be quite practicable from a technical point of view as far as wireless is concerned. I am not so sure, however, as regards the land-line system involved. Judging by last night's (December 30th) transmission over the lines from Manchester, there remains much to be done in this direction. The cut-off in the lower register was very pronounced. This on a receiver which normally gives most faithful reproduction. With this difficulty overcome, the scheme presented would be welcomed by the great majority of, and probably all, listeners, whilst, in addition, one can visualise a boom in the radio industry. Given a scheme on the above lines, and the Robinson Radiostat, we shall be wondering what to do with all our spare ether channels!

H. A. HANKEY.

Sir,—I have read with considerable interest the article under the above heading in your current issue, but I cannot help thinking that the suggested scheme is "too good to be true"! If not, how is it that someone has not thought of it before? There must be a snag somewhere, though the writer states his

case very convincingly. If there is no "nigger in the wood pile," it would seem that the MacCallum Scheme provides a complete solution of the programme difficulties, and its adoption should bring real prosperity to the radio industry and satisfaction alike to the listener and the B.B.C.

Oxhey, Herts.

W. E. WARRILOW.

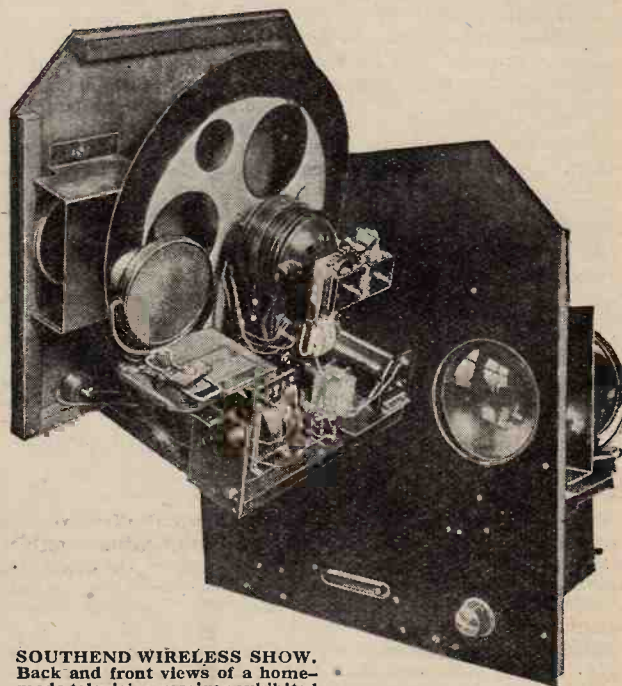

**SOUTHEND WIRELESS SHOW.**

Back and front views of a home-made television receiver exhibited by Mr. A. Knipe. It is fitted with the standard arrangement of toothed wheel synchronisation. The cathode of the neon lamp glows on both sides, a concave mirror being provided to bring the light emitted from the electrode to the scanning disc.

Sir,—Major MacCallum's article in your issue of December 25th was most interesting. He refers to the probable objection of the absence of "local colour" in his scheme, but I cannot see why there should be. What does it matter where the programme comes from as long as it is good?

Schubert's "Unfinished Symphony," for example, will be just the same whether it is played at John o' Groat's or Tim-

buctoo. It matters little if a lecture on the peculiarities of fish has its origin at Savoy Hill or Glasgow, providing there is no land-line distortion. That is the trouble: the mutilation of programme matter by chronic land-line distortion.

However, the article was, as stated, not without interest, and I hope to see more of this kind of reading.  
London, N.1. F. H. HEINEMAN.

Sir,—I venture to put forward the following four propositions as raising questions of some interest and importance to provincial listeners:—

(1) It is not possible in practice for a number of transmitters, even though using low power and radiating one programme, to operate within a restricted area on the same wavelength without mutual interference.

(2) There is mutual interference between B.B.C. common wave transmitters.

(3) All B.B.C. transmissions on the common wavelength are therefore of bad quality.

(4) In the matter of oscillation interference, the B.B.C. are themselves the chief offenders.

It will be borne in mind that as many as eleven transmitters in Great Britain, from Dundee in the north to Plymouth in the south, share at present the common wavelength of 288.5 metres. If the regional scheme in its present shape is brought to completion, subsidiary stations, for which there will be no independent wavelength available, will be needed at Aberdeen and Newcastle.

There are two essential elements in a good wireless programme—good quality transmission and good quality programme matter. The two are complementary, one being as necessary as the other. In the case of the indifferent programme, good quality transmission may make poor programme matter tolerable, bad quality transmission can reduce the best programme matter to the level of the worst. It may be said, therefore, that a symphony concert relayed from the London Queen's Hall is a good programme only for those within the service area of the London transmitter. For listeners elsewhere, the quality of transmission is impaired or destroyed by the use of land-lines and the inherent defects of common wave transmission.

These clear and simple considerations indicate the terms in which the provinces should formulate any demand for a better service. The demand should be for—

(a) Direct transmissions of (b) good programme matter on (c) an independent wavelength.

It is certain, however, that any such demand would have a chance of success only if it were pressed with energy and determination. Present signs—among them in particular the salvaging of the London Promenade Concerts, the formation of the National Orchestra in London, the scheduled expenditure of some half a million pounds on the erection in London of Broadcasting House—all clearly foreshadow the permanent centralisation of the service in London and a continuation of the evil system of land-line transmission to the provinces.

Newcastle-on-Tyne.

K. McCORMACK.

#### OSCILLATION.

Sir,—It seems to me that the only way out of the trouble (oscillation) is for the Post Office or British Broadcasting Corporation authorities to make a standard test of the impending listener's set before same is licensed, and, unless such a radio installation came up to a proper standard, the licence should be refused.

This law would speedily rid the radio business of the "all and sundry" that have come into it without any qualifications whatever, to the absolute detriment of the service and public alike.

HERBERT W HAYDON, G.2Z.L.

Gloucester.

#### OVERSEAS BUYERS.

Sir,—As an interested subscriber to your valuable paper, may I suggest that you can render extremely valuable assistance to overseas experimenters and assist the popularity and prosperity of wireless in parts of the world where business is not sufficiently great for the establishment of local enterprise by maintaining an overseas buying department

I speak from experience when I say that one of the greatest difficulties experienced is that of obtaining a supply of parts for the construction and maintenance of sets.

I submit that you are in a unique position to meet this difficulty, and, moreover, you would be able to test parts before despatch, thus reducing the possibility of failure and dis-appointment to a minimum.

So far as I am aware, there is no dealer in wireless material in the whole of this country, so that you would not be intruding into a sphere which, in ordinary circumstances, you would be disinclined to do.

The purchase of wireless material through friends at home is not always a success, and it is exceptional to have a friend in the position to purchase and test apparatus before despatch, to say nothing of the trouble entailed by the latter.

Northern Nigeria.

WILFRED H. MILES.

[The above suggestion, although entirely outside the sphere of *The Wireless World*, might well be considered by the appropriate sections of the radio-trade.—Ed.]

#### THE BRITISH MANUFACTURER.

Sir,—Two letters in your January 1st issue do, I think, need a little backing up or amplifying. I refer to those over the signatures of A. H. Gregson and F. Nichols.

One reason why the Germans and Americans hold their market in this country is that they deliver the goods within a reasonable period of their being ordered. There are only about two British firms that ever do this. I have proved this by bitter and costly experience. My business is to make good-quality receivers and do general repairing and modernising of any set. Needless to say, I need a large variety of different valves and components, and in order to do the best work I carefully follow the advertisements and technical articles in *The Wireless World*. In all cases I try out new components and circuits before recommending them to customers.

Now when some new component is advertised or recommended I have to decide where to get it. I naturally consider the factor, as it saves time to order from him along with other stuff; but it would appear that this gentleman does not keep himself up to date by reading, and does not order new goods for stock until there has been a continual large demand for them for several months.

I then fall back upon the manufacturer, and the following is an actual case that has happened to me recently, and is typical of what happens in very many cases.

Ordered article September 27th; no acknowledgment of order.

Ordered a second one November 15th, and asked that they should be expedited.

Received letter November 27th stating could not deliver until early in December.

Sent postcard December 12th; no reply.

Telephoned double long distance call December 30th, and spoke to sales manager.

Goods arrived December 31st.

Now, if they could post them off at once like that, why not have done it before? This latter is a very favourite trick—to send goods when telephoned for—and reduces my profit by the price of a double trunk call. I literally cannot afford to deal with firms who treat my orders in this manner.

Mr. Gregson's remark that the makers have to see what the demand is likely to be before producing in quantity does not point to much confidence in the goods on the part of the maker, and, anyhow, this does not apply in the case of such things as valves of proved superior qualities, as there is sure to be a demand for such at once and in large quantities, if they really are good.

One firm wrote me that their orders had been so large that their packing staff could not deal with them!! What about increasing the packing staff for the busy season?

I am not sure that the Exhibition should be held any earlier, as any suggestion that the dummy goods exhibited then will not be available for another three months or more will simply cause the public and provincial traders to treat the show as a joke, and those three months will be a general slack season.

My orders are going to those who deliver promptly—of any nationality.

GUY S. M. ASHBY.



**PICTURE RECEPTION.**

Sir,—May I endorse the statements of Mr. Walter Addey in your issue of January 1st, 1930, on the subject of Picture Transmission? I have been constructing a picture machine after the pattern of *The Wireless World* design, and it is now just finished, only to find the transmission of pictures has been discontinued.

I was given to understand by Messrs. Wireless Pictures (1928), Ltd., that the B.B.C. would be transmitting for some time to come. (This was in August, 1929.) Therefore, the sale of instruments to the public is, in my opinion, ridiculous.

As Mr. Addey says, "Pictures are to be received from Vienna," but until we have adjusted our instruments and tested them on a reliable transmission we cannot hope to overcome fading effects, etc.

I shall be pleased to hear from any other readers in a similar plight, should you publish this letter.

Many thanks for your valuable paper—still splendid value at its increased price.  
H. W. HOWLETT.

**THE ROBINSON "STENODE RADIOSTAT."**

Sir,—I read with considerable interest the article, under the above heading, which was published in *The Wireless World* of December 11th, 1929, but perhaps you will permit me to comment on the latter part of the article, in which the writer states he is puzzled by the fact that true reproduction can accompany almost perfect selectivity in a radio receiver. In recent years considerable misconception has arisen regarding the theory of the transmission and reception of radio frequencies modulated by audio frequencies, and it is probable that it was this misconception which was responsible for the writer being puzzled.

In modern wireless literature it is repeatedly stated that the modulation of constant frequency carriers produces "side bands" or subsidiary frequencies equal to the sum or difference of the modulation and carrier frequencies. This, however, is a statement which I believe to be neither borne out in fact, nor theoretically accurate. To take an example: If a carrier of 1,000kC. is modulated by 1kC., there will be only one frequency radiated, namely, 1,000kC., the amplitude of which, however, will fluctuate one thousand times each second. The production of beat frequencies, of course, cannot take place, as there is too great a difference between the primary frequencies. The study of an oscillograph record should make the matter quite clear; the modulation of 1,000 cycles per second by one cycle will produce a graph with the peaks of the waves having a figure 8 formation, but in no case will frequencies of 1,001 or 999 be traced. When two transmitters are heterodyning, a whistle of varying amplitude, but constant pitch, is produced, but if side bands existed the pitch would vary with the modulation.

This misconception has received considerable support in view of the fact that highly selective receivers have hitherto been unable to reproduce all the audio frequencies in correct proportion. This fault, however, is not because the receiver is selective and so "cuts the side bands," but because of the method whereby selectivity is attained. Such a receiver has employed one or more high-frequency resonant circuits and, from the nature of these circuits, it follows that the less resistance or damping employed the longer time will it take the current to change from one amplitude to another. In the case of high

audio frequencies the amplitude changes have to be very rapid, with the result that the persistence of the current in the circuit tends to smooth them out. The matter can be reasoned from another angle. If side bands are necessary, as far as reception is concerned, a receiver designed to respond to one frequency only would be incapable of detecting any modulation. Such a proposition is out of the question, since, whether or not we hold that side bands are produced, it is unquestionable that the amplitude of a carrier varies as it is modulated.

Present-day receivers are affected by the heterodyning of two transmissions because both the frequencies are received, whereas, if the receiver responded to one only of the frequencies, however closely it approached the other, the heterodyne note would not be heard.

From the foregoing remarks it will appear that there is no theoretical reason as to why a receiver designed to be highly selective should not be entirely successful, providing that selectivity is not achieved wholly by the aid of undamped resonant circuits. Dr. Robinson is to be congratulated if he has succeeded in producing such an instrument.

London, E.10.

F. STUBBINGS.

**THE SUPERHETERODYNE.**

Sir,—The reasons for the unpopularity of the superhet in England are these:—

1st.—The necessity for extreme selectivity is not so urgent. Transmitting stations are not so broadly tuned as they are in France.

2nd.—The British public have been accustomed to very simple tuning devices and seem afraid to buy a set that requires a little more attention to tuning in.

3rd.—A superhet requires more valves and consequently increases the price of the set. The price of a general-purpose valve in France is 37 frs. 50 (about 6s. 3d.), whereas in England it is 10s. 6d.

As a representative of British firms in France, I am up against the selectivity problem every day. The first question one is asked at the dealers is, "Is it a 'changeur de fréquence?'" One has to stay no, and then many firms will not even trouble to listen.

It is quite impossible in Paris with the usual circuits used in England to eliminate Radio Paris and Eiffel Tower and obtain Daventry, which every Frenchman wants.

The screened grid is an improvement, but not as selective as the superhet, which in experienced hands is quite as good and pure as any straight circuit.

Why have British manufacturers neglected this market? What they have missed I am in a position to know.

I recently represented a large British portable set manufacturer who eventually started a factory in France. I tried to convince them that the superhet was the only circuit that would sell here, but they decided that the set was doing well in England and must be made to go well in France!

The result was that Daventry could never be received without interference from Radio Paris and Eiffel Tower. What hopes has a British firm of doing satisfactory business on these lines? Whatever British firms do to-day, if only they would build a superhet for the French market they would do ten times the business.

Paris.

A. J. HILL.

*Elements of Radio Communication*, by J. H. Morecroft (Chapman and Hall, 1929. 15s. net. Pp. 269). Professor Morecroft's well-known standard work, "Principles of Radio Communication," has now passed through several editions and is an indispensable work of reference to the professional wireless designer, but is somewhat heavy reading for the student and the amateur. The present work is of a simpler character, and may be considered as an introducing volume to the larger book.

Though the treatment is elementary in that no mathematical equipment beyond a

**BOOK REVIEW.**

knowledge of algebra is required, yet the subject is dealt with in a more solid fashion than in the average popular exposition. The principle is to give first an account of the theory of alternating currents, with special reference to the requirements of wireless telegraphy and telephony and to follow this with the applications involved in modern practice. The numerical information given is un-

usually complete. Thus, we are given figures as to the absorption of waves by steel buildings, the relative ranges and ship distances of transmissions on various wavelengths, and the comparative rectifying powers of crystals and valves using anode-bend or cumulative detection.

The chapter on receiving sets gives a most readable account of the good and bad points of modern sets. It begins with crystal circuits and treats of loud speakers, amplification units, superhets, various types of H.F. and L.F. amplifiers, and ends with mains-fed sets and filter systems.

R. T. B

# Broadcast Brevities

By Our Special Correspondent.

## The World Listens.—The Question of News Bulletins,—New Regional Tests.

### The World's Biggest Broadcast.

If the International Disarmament Conference were being held in a studio at Savoy Hill the powers that be could show no greater deference to the peculiar requirements of broadcasting than they will on January 21st. For the special benefit of the world's listeners, H.M. the King and ten representatives of the Great Powers will observe a rigid time-table which will bring all their speeches within the compass of two hours.

o o o o

### Order of Speeches.

Immediately after the King's speech, which begins at 11 a.m., His Majesty will leave the Chamber, the chair then being taken by the Rt. Hon. Ramsay MacDonald.

I learn from an authoritative source that the subsequent speeches will be given in this order: (1) Mr. Ramsay MacDonald, (2) Mr. Henry Stimson (U.S.A.), (3) M. André Tardieu (France), (4) Signor Dino Grandi (Italy), (5) Mr. Kanami Wakasugi (Japan), (6) Col. the Hon. J. L. Ralston (Canada), (7) Mr. J. E. Fenton (Australia), (8) Hon. T. M. Wilford (New Zealand), (9) Mr. C. T. ter Water (South Africa), and (10) Sir Atul Chandra Chatterjee (India).

o o o o

### B.B.C.'s Responsibility.

The delegates will be seated round a horseshoe table and each will be provided with a microphone extension. The B.B.C. control engineer will be discreetly inconspicuous just outside the door.

There can be little doubt, I think, that this broadcast will be the biggest of its kind ever staged. Ten nations have a direct interest in the proceedings of the Conference, while nearly every other country will hold a watching brief. Europe will be listening to Daventry, or via special landlines to Continental transmitters, and the rest of the world will be doing its best to hear 5SW. The B.B.C. has a big responsibility.

o o o o

### Dreary News Bulletins.

"Brighter news?" was the question that leapt to everyone's lips at the announcement of a staff change in the Savoy Hill news department. I doubt whether the change will have any effect whatever, but the B.B.C. is scarcely to be blamed on that account.

Unlike a newspaper, the broadcasting machine gives no time even for a "proof"; sub-editing is reduced to a minimum, as many items of news come in while the announcer is actually reading the bulletin. I believe a scheme of

broadcast "headlines" was once considered with the idea of making the items more attractive, but it was not found practicable. Some means should be found, however, to brighten up one of the duller features of the broadcast service.

o o o o

### Special Radio Week Feature.

I see that one of the organs of the B.B.C. prints a sonnet "to be broadcast, with other poems, by Elizabeth Barrett Browning, on January 14th." Seeing that this is National Radio Week, the B.B.C. might have gone a step further by giving us a sonnet from the lips of Will Shakespeare himself.

o o o o

### New Tests from Brookmans Park.

Only seven thousand letters have been received at Savoy Hill regarding the Brookmans Park tests. This is a negligible figure compared with the vast numbers who are known to be within the service area, and the inference might be that the twins are giving satisfaction. The real truth, of course, is that the really serious tests have yet to come. So far few people can have been inconvenienced by the simultaneous transmissions, but I hear that the tests will be much more drastic in a week or two, with music from both transmitters. Up to

the present this has been attempted only at unimportant times: in the afternoon, for instance.

Not until the final test period begins will it be possible to say when the twin transmitters will begin their permanent service of simultaneous transmissions. The final tests will probably last three or four weeks.

o o o o

### Present Schedule.

Until further notice, the arrangement of the alternative programme test transmissions from Brookmans Park is as follows:—

The published programme is transmitted by the National programme transmitter working on a wavelength of 261 metres and by Daventry 5XX, from 12 noon to 1 p.m. on Monday to Fridays, and from 1 p.m. to 2 p.m. on Saturdays. The whole of the late dance music which follows the studio programme each evening is transmitted also by the National programme transmitter on a wavelength of 261 metres and by Daventry 5XX. During the whole of these periods the 356-metre Regional programme transmitter radiates a contrasted programme. On Sundays there will be no test transmissions in the evenings, but the alternative programme test transmissions will take place as usual between 2 and 2.50 p.m.

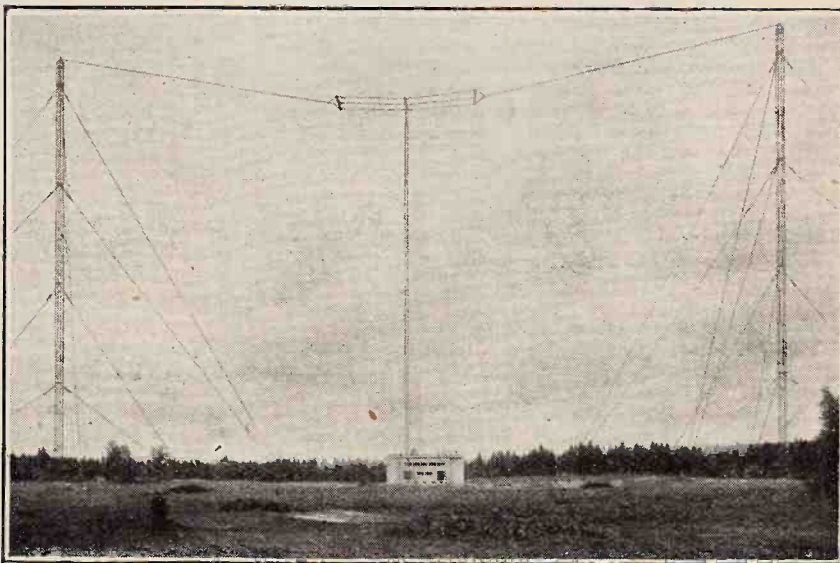

THE NORWEGIAN GIANT. The new 60-kilowatt broadcasting station at Oslo, just completed by the German Telefunken Company. Operating on 493 metres, Oslo can be heard at most times of the day in Great Britain.

READERS

"THE WIRELESS WORLD" SUPPLIES A FREE SERVICE OF TECHNICAL INFORMATION

PROBLEMS

The Service is subject to the rules of the Department, which are printed below; these must be strictly enforced in the interest of readers themselves.

A selection of queries of general interest is dealt with below, in some cases at greater length than would be possible in a letter.

Juggling with Grid Bias Cells.

I am using, as an anode bend detector, a high-impedance valve which apparently requires a bias of something between 1½ and 3 volts (the voltages of one or two dry cells). To avoid the need for fitting a potentiometer, I recently obtained one of the new 0.9-volt bias cells, and have connected it in series with an ordinary dry cell; although signals are louder, I think that the valve would work still better with slightly less negative on its grid. Is it safe to try the expedient of reversing the polarity of the low-voltage cell connections? D. D. L.

No harm can be done by trying this experiment, and we suggest that you should connect two ordinary dry cells in series and then join up the 0.9-volt cell in opposition. This would give an effective voltage of 2.1, which should be about right.

An Extra Tuned Circuit.

I understand that the addition of a separately tuned and loosely coupled aerial circuit will increase the selectivity of my Kilo-Mag Four receiver. Is it reasonable to assume that this addition will also bring about an appreciable increase in its range? H. T. L.

Under average working conditions, it is safe to assume that a separate tuned aerial circuit will add to the range of a receiver, as compared with the "aperiodic" arrangement which it usually displaces. At any rate, it is quite safe to make this assumption if the comparison

RULES.

- (1.) Only one question (which must deal with a single specific point) can be answered. Letters must be concisely worded and headed "Information Department."
- (2.) Queries must be written on one side of the paper, and diagrams drawn on a separate sheet. A self-addressed stamped envelope must be enclosed for postal reply.
- (3.) Designs or circuit diagrams for complete receivers cannot be given; under present-day conditions justice cannot be done to questions of this kind in the course of a letter.
- (4.) Practical wiring plans cannot be supplied or considered.
- (5.) Designs for components such as L.F. chokes, power transformers, etc., cannot be supplied.
- (6.) Queries arising from the construction or operation of receivers must be confined to constructional sets described in "The Wireless World" or to standard manufacturers' receivers.

Readers desiring information on matters beyond the scope of the Information Department are invited to submit suggestions regarding subjects to be treated in future articles or paragraphs.

is to be made on a basis of equal selectivity; a two-circuit aerial tuner with coupling adjusted for loudest signals gives better results than an "aperiodic" arrangement similarly adjusted.

When Valves Fail.

My present valves have been in use for well over two years, and as the signals given by my receiver are not as good as formerly, I have come to the conclusion that this falling off is due to a partial failure of valve emission; at any rate, a careful point-to-point and stage-by-stage test with the apparatus at my disposal fails to reveal any fault. Will you tell me if there is any simple and easy way of checking the emission of the valves without the need for any elaborate equipment? M. K.

A milliammeter with a range depending on the characteristics of the valves to be tested is sufficient equipment to enable you to form an idea as to whether your valves are in order in the matter of their emission. First connect the milliammeter in the anode circuit of the valve under test, taking care to short circuit any transformer primary or other resistance of appreciable value that may be in series. Next, having set grid bias and anode voltages at convenient values, observe if the anode current indicated is reasonably near (say within 25 per cent.) to that indicated by the manufacturer's published curve.

Even without any apparatus at all it is possible in some cases to form a very fair opinion as to the state of the valves, provided one can assume that the various batteries are in order. When it is found that an L.F. amplifying valve cannot be used with the full value of negative grid bias recommended by its makers without introducing obvious distortion, it can generally be assumed that emission has fallen off considerably.

A Gramo-Radio "Kit Set."

Will you please give me some hints as to how the "Wireless World" Kit Set" may be adapted for use with a gramophone pick-up? If possible, I should like to arrange matters so that the pick-up is permanently connected to the receiver, with a switch to put it into circuit when required. J. L. A.

We suggest that the pick-up should be inserted in the grid circuit of the detector valve in the manner shown in Fig. 1. The single-pole change-over switch necessary for the conversion can conveniently be mounted on the upper part

of the base, with its operating lever protruding into the lower compartment; it may be operated by a rod projecting through the front panel. It is here assumed that your set is constructed in the same manner as the original model described in these pages.

As a refinement, an extra pole may be added to the radio-gramophone switch, so that the H.F. valve filament will be

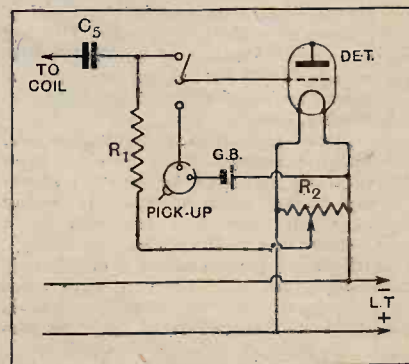

Fig. 1.—Gramophone pick-up connections for "The Wireless World" Kit Set.

automatically switched off when this valve is not in use. Of course, this operation can be carried out, if preferred, by means of the rheostat already fitted.

A Double-purpose Resistance.

Will you please criticise the circuit diagram of my proposed four-valve receiver? Valve types and resistance and capacity values are marked. Please say if these are suitable. S. P. S.

Your diagram shows a fairly conventional H.F.-det.-2 L.F. receiver; in general, it should give satisfactory results, but we expect you will find it necessary to alter the ratio of the H.F. transformer (shown as 1:1), or to add another tuned circuit. The set as it stands will lack selectivity for use in your locality.

The decoupling resistance in the detector anode circuit should be increased from 600 ohms (as shown) to about 20,000 ohms. It must not be forgotten that in this circuit we are dealing both with H.F. and L.F. currents; it is probably true to say that the latter are most likely to give rise to trouble, and they must be taken into account when determining the values of decoupling components. The associated by-pass condenser should be increased in capacity from 0.1 mfd. to 2 mfd.

**Detector Anode Milliammeter.**

My receiver is a 1-v.2 combination, with anode bend detector coupled by a high-inductance choke to the first L.F. amplifier, which is coupled to the output valve by a transformer. A post-detection volume control is fitted, in the form of a quarter-megohm variable resistance shunted across the L.F. choke.

The set works well, but I have been puzzled, since fitting a detector anode milliammeter as an indicator, by the fact that quite good and very loud signals are obtained from many stations without any observable change taking place in anode current reading. So far as several nearer and more powerful transmissions are concerned, it is quite easy to get a maximum deflection of between one and two milliamperes; of course, in these conditions it becomes necessary to use the volume control to prevent overloading.

Even after dark, it is unusual to find any great number of stations whose signals bring about an increase of more than a small fraction of a milliamperere.

Does the above suggest that anything is wrong? Grid bias has been carefully adjusted by ear; the standing current when no signal is coming in is, as near as I can read it, a quarter of a milliamperere. E. F. R.

Without full particulars of your set, and, more important still, practical experience of your local receiving conditions, it is impossible to say definitely that the per-

formance you describe is everything that can be expected. On the whole, we think that you can have little cause for concern, as the receiver seems to be working quite well.

formance you describe is everything that can be expected. On the whole, we think that you can have little cause for concern, as the receiver seems to be working quite well.

reading of about one milliamperere, assuming normal working conditions).

Although you give no particulars of your milliammeter, we are inclined to think that your apparent difficulty in taking fractional readings is a proof that the instrument is less sensitive than is desirable for this sort of work. Generally speaking, a scale reading of 0.15 or 0.2 milliamperes is to be recommended.

o o o o

**A "Tune-stand-by" Switch.**

I am planning a new receiver, which is to include a separately tuned aerial coupled to the grid circuit through a small variable condenser connected between the centre points of the two coils. Is it possible, without introducing any serious losses, to fit a switch for cutting out the tuned aerial circuit at will? My object is to simplify operation of the set when searching for transmissions of which the corresponding condenser adjustments are not known. N. G. P.

In the design of commercial and "Service" apparatus it has always been quite usual to include a so-called "Tune-stand-by" switch for this purpose, and, now that two-circuit aerial tuners are coming into more general use for broadcast reception, this is a practice that might well be imitated. It is very likely to be helpful in your own particular case, as we see that you live at a considerable distance from a transmitting station, and consequently you will not always need the higher selec-

**Transformer Primary Condensers.**

With reference to your recent article on the subject of parallel-fed L.F. amplification, will you please tell me if there is any reason why an L.F. transformer with a built-in condenser in shunt with the primary winding should not be used in circuits of this sort? If not, would it be satisfactory to remove the condenser?

W. L. S.

The effect of this condenser—from the "L.F." point of view—is allowed for by the manufacturers, and these transformers can most certainly be used with entirely satisfactory results. The condenser should not be removed.

o o o o

**Porcelain Connectors.**

I recently saw some small porcelain blocks fitted with brass insets carrying nipping screws; these were used for securing some of the connections of an experimental receiver. Having had some experience of burning out valves through short-circuits between temporary leads, these little "gadgets" attracted my attention. Can you tell me what they are called and where they may be obtained?

These are known as porcelain connectors, and we are rather surprised that you should have any difficulty in obtaining them. They are usually stocked by dealers in small electrical fittings, and are made with one, two or three insets for similar numbers of conductors. We agree that they are very useful for making safe semi-permanent connections.

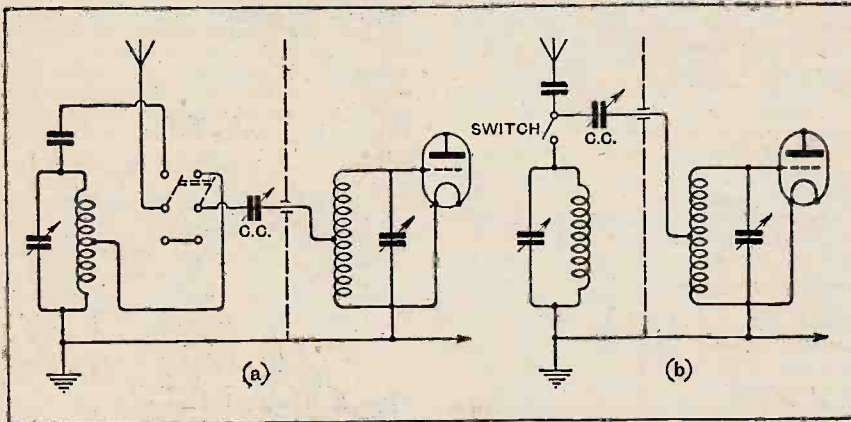

Fig. 2.—Methods of switching out the tuned aerial circuit of a capacity-coupled two-circuit tuner.

tivity conferred by the separately tuned aerial circuit.

For the arrangement you describe the form of connection shown in Fig. 2 (a) is suitable; an "aperiodic" coupling is provided when the switch is "down."

It may be pointed out that matters may be simplified if you change your circuit slightly, and adopt the arrangement suggested in Fig. 2 (b). Provided the coupling condenser (C.C.) has a suitably low minimum value, this is practically as effective, and requires nothing more than a single-pole on-off switch for its execution.

**FOREIGN BROADCAST GUIDE.****KHARKOV**

(Russia).

Geographical Position: 50° N. 36° 14' E.  
Approximate air line from London:  
1,580 miles.

Wavelength: 1,304 m. Kilocycles:  
230. Power: 12 kW.

Time: Eastern European (two hours in  
advance of G.M.T.).

**Standard Daily Transmissions.**

Time signal at 17.00 G.M.T. a long buzz  
followed by chimes on a gong to  
indicate 19.00 Eastern European Time.

08.00 and 09.00 morning concert; 18.00  
and 20.00 main evening programme;  
21.00 dance music (Saturdays only).

Frequently relays programmes from  
Moscow Komintern and Leningrad.

Man and Woman announcers. Call  
(phonetic): Rhar-low (thrice) govoreet  
Kharkovska rah-dee-owe-mov-na stant-  
see-ya Narkom-potsch-tel, Abbreviated  
call during intervals: Rhar-low, rah-  
dee-owe Kharkov.

Interval signal: gong.

These transmissions are also broadcast  
by a 4 kilowatt station on 426 m.  
(704.2 kc.).

# SOUTH POLE speaks to LONDON!

IN FAR Antarctic wastes . . . Sir Douglas Mawson charts unknown continent. Sights new island. Wirelasses to London — *through Marconi Valves*. "Discovery" uses them — to keep touch with civilization, with supply ship, with accompanying airplane. Cable Service to Australia . . . Empiradio Beam Wireless . . . all British Broadcasting Stations . . . use Marconi Valves. For their wide range. For their long life. For their reliability.

*In cases like these, when unflinching efficiency is essential — a matter of life and death even — men insist on Marconi Valves*

**FIT**

## MARCONI VALVES

**TO YOUR RADIO SET**

Give you clearer tone, greater volume, longer range. Cost not a penny more. Fit any set.

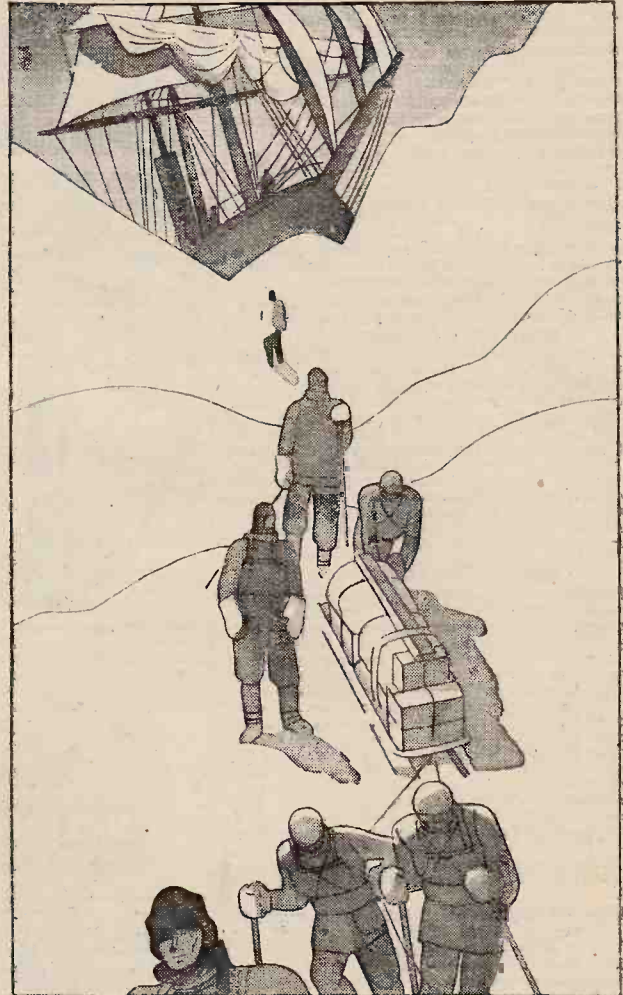

**The first and greatest name in wireless**

# MISCELLANEOUS ADVERTISEMENTS.

## NOTICES.

**THE CHARGE FOR ADVERTISEMENTS** in these columns is:

12 words or less, 2/- and 2d. for every additional word.

Each paragraph is charged separately and name and address must be counted.

**SERIES DISCOUNTS** are allowed to Trade Advertisers as follows on orders for consecutive insertions, provided a contract is placed in advance, and in the absence of fresh instructions the entire "copy" is repeated from the previous issue: 13 consecutive insertions 5%; 26 consecutive, 10%; 52 consecutive, 15%.

**ADVERTISEMENTS** for these columns are accepted up to **FIRST POST ON THURSDAY MORNING** (previous to date of issue) at the Head Offices of "The Wireless World," Dorset House, Tudor Street, London, E.C.4, or on **WEDNESDAY MORNING** at the Branch Offices 19, Hertford Street, Coventry; Guildhall Buildings, Navigation Street, Birmingham; 260, Deansgate, Manchester; 101, St. Vincent Street, Glasgow, C.2.

Advertisements that arrive too late for a particular issue will automatically be inserted in the following issue unless accompanied by instructions to the contrary. All advertisements in this section must be strictly prepaid.

The proprietors retain the right to refuse or withdraw advertisements at their discretion.

Postal Orders and Cheques sent in payment for advertisements should be made payable to **LIFFE & SONS Ltd.**, and crossed **& Co.** Notes being untraceable if lost in transit should not be sent as remittances.

All letters relating to advertisements should quote the number which is printed at the end of each advertisement, and the date of the issue in which it appeared.

The proprietors are not responsible for clerical or printers' errors, although every care is taken to avoid mistakes.

### NUMBERED ADDRESSES.

For the convenience of private advertisers, letters may be addressed to numbers at "The Wireless World" Office. When this is desired, the sum of 6d. to defray the cost of registration and to cover postage on replies must be added to the advertisement charge, which must include the words Box 000, c/o "The Wireless World." Only the number will appear in the advertisement. All replies should be addressed No. 000, c/o "The Wireless World," Dorset House, Tudor Street, London, E.C.4. Readers who reply to Box No. advertisements are warned against sending remittance through the post except in registered envelopes; in all such cases the use of the Deposit System is recommended, and the envelope should be clearly marked "Deposit Return."

### DEPOSIT SYSTEM.

Readers who hesitate to send money to unknown persons may deal in perfect safety by availing themselves of our Deposit System. If the money be deposited with "The Wireless World," both parties are advised of its receipt.

The time allowed for decision is three days, counting from the receipt of goods, after which period, if buyer decides not to retain goods, they must be returned to sender. If a sale is effected, buyer instructs us to remit amount to seller, but if not, seller instructs us to return amount to depositor. Carriage is paid by the buyer, but in the event of no sale, and subject to there being no different arrangement between buyer and seller, each pays carriage one way. The seller takes the risk of loss or damage in transit, for which we take no responsibility. For all transactions up to £10, a deposit fee of 1/- is charged; on transactions over £10 and under £50, the fee is 2/6; over £50, 5/-. All deposit matters are dealt with at Dorset House, Tudor Street, London, E.C.4, and cheques and money orders should be made payable to Liffe & Sons Limited.

### THE SALE OF HOME-CONSTRUCTED UNLICENSED APPARATUS.

#### A Service to our Readers.

We have made an arrangement with the Patentes whereby readers who wish to dispose of a home-constructed receiver not licensed under the patents made use of, can license the set by means of the Deposit System referred to above.

The person desiring to sell, in sending us particulars for his advertisement, will in every case make use of a Box No., and should add to the price which he requires the amount of royalty customarily paid by manufacturers.

If the purchaser is satisfied with his purchase, the sum realised will be forwarded to the seller, less the amount due in respect of royalties, which amount will be paid by "The Wireless World" to the owners of the patents concerned, and a certificate will be handed on to the purchaser of the set.

**SPECIAL NOTE.**—Readers who reply to advertisements and receive no answer to their enquiries are requested to regard the silence as an indication that the goods advertised have already been disposed of. Advertisers often receive so many enquiries that it is quite impossible to reply to each one by post.

**B&J ALL WIRELESS WORLD COILS**

1930 EVERYMAN FOUR	47/6 set
KIT SET, Coils with Switches	45/- set
NEW KILOMAG.	45/- set
RECORD III	45/- set
FOREIGN LISTENERS 4 B.B.C.	30/- set
METAL CABINETS	5XX 37/6 set
5 1/2" DRUM DIALS with Escutcheons	5/6
WAVE TRAP, Litz Wire	10/6 each

**B&J. Wireless Co.**  
2, 3, & 4, Athelstans Mews,  
Stroud Green Road, N.4.  
Archway 1695

"END OF YEAR CLEARING."

## APPLEBY'S

FOR BARGAINS WATCH Phone: Paddington 8828 (3 lines)

THE MISCELLANEOUS COLUMNS THIS MONTH.

For Modern High-grade Material Only.

**CHAPEL ST., LONDON, N.W.1**  
OPEN TILL 7 P.M. SAT. 1 P.M.

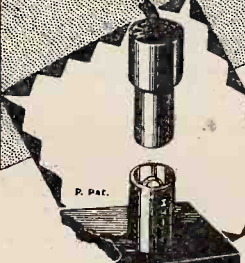

**BOTH PLUG & SOCKET COMPLETELY INSULATED**

Shocks impossible—the essential Plug and Socket for Mains-operated sets, and wherever fool-proof connections are needed. Engraved name on both parts—ample contacts—ease of fixing. Equip your set or eliminator with them. The first Plug and Socket in which both parts are engraved and entirely insulated when connected or disconnected.

(Panel portion 3d. Flex portion 6d.)

Ask your dealer, or send to us, for Belling-Lee Handbook, "Radio Connections."

**BELLING-LEE**  
FOR EVERY RADIO CONNECTION

Advt. of Belling & Lee Ltd., Queensway Works, Ponders End, Mdx.

## A 6d Insurance Policy

IF you want genuine fuses see the name "COMPETA" stamped on the cap and orange carton. Ordinary cheap flashlamp bulbs are very unsafe to use. Ask firmly for "COMPETA."

FROM ALL DEALERS

06  
15  
2  
AMPS

**TRADE MARK**  
**COMPETA**  
THE WORLD'S SELECTED

Advt. of A. F. BULGIN & Co., 9/10/11 Curstler St., London, E.C.4.

## RECEIVERS FOR SALE.

**SCOTT SESSIONS** and Co., Great Britain's Radio Doctors.—Read advertisement under Miscellaneous. [0264]

**3-VALVE** All-wave Receiver, latest type, powerful, perfect; £4.—V. Taylor, 57, Studley Rd., Stockwell, London. [0274]

**RECEIVERS** for Sale.—Portable 5-valve, suit case type, complete, as new, perfect; £9/17/6.—N. Taylor, 57, Studley Rd., Stockwell, London. [0323]

**WIRELESS** Portable Sets, with 5 Cossor new process valves, for 9 guineas; less than components cost, comparable with any set double this price, Royalty paid; seen between 1 and 2 p.m., or particulars sent on receipt of stamped addressed envelope.—G. Hodgson, 53, Windsor House, Victoria St., Westminster. [7737]

**READ** and **MORRIS**, Ltd., the mains pioneers, who in 1925 equipped the hospital with mains sets, still supreme in all-mains receivers and units.

**LOW Tension A.C. Eliminators**, permanently replacing batteries, now only £5/15; electrolytic condensers, 2,000 m.f., as used in above, 13/-; including postage.

**BARGAINS.**—Second-hand sets, units, meters, speakers.—Read and Morris, Ltd., 31, Eastcastle St. (facing back of Waring's), Oxford St., W. [7769]

**SUPER** Range 3-valve Set, guaranteed, genuine, complete with all accessories, new; 9 guineas; approval 7 days.—Box 4377, c/o The Wireless World. [7828]

**GREAT Opportunity.**—Having many requests for famous Royal Air Force 3-valve receivers, we have now procured limited number; these receivers give excellent loud-speaker reception, each set specially tested before delivery to ensure satisfaction, all are guaranteed brand new and perfect; the original cost of these sets was £18; special travelling case with each set; we are sacrificing at the absurdly low price of 32/6.

**GUARANTEED** and Absolutely New McMichael Supersonic Kits, including mahogany cabinet, book instructions, blue prints; clearance price only £3; these sets can get the whole world; without cabinet, price £2.

**J. B. HUMPHREYS** and Co., 23, College Hill, Cannon St., London, E.C.4. [7802]

**PYE** Portable 5-valve Set, latest model, never been used; £17/10 only.—Box 4435, c/o The Wireless World. [7875]

**MARCONI** 51B, complete, 5-valve A.C. mains receiver, with Rice Kellogg speaker, in magnificent mahogany pedestal cabinet, as new; list price £90, special bargain price £37/10.—Mills, 65, Grainger St. West, Newcastle. [7874]

**LIBERTY** Super Heterodyne, complete with 8 Mullard valves, never used; cost £31, sacrifice £12, or useful exchange.—Leaver, 38, Baker St., Sparkhill, Birmingham. [7873]

**MARCONI** Three Valve Model 37, new; cost £5/10, accept 70/-; Braudes table talker, 10/6.—80, Cloughton St., St. Helens. [7871]

**WE Offer You the Following Inducements to Purchase Your New Receiver or Other Apparatus from us.**

**FIRSTLY.**—Unbiased advice. The Principal of the firm has twenty years' professional wireless experience, having been at Government Experimental Stations in 1910. He has been Manager for the Sterling Telephone Co., radio expert to the G.E.C., and Chairman of the Technical Committee of the National Association of Radio Manufacturers. His advice has saved our clients many thousands of pounds, for, as everybody knows, there is no hobby on which more money is wasted on useless apparatus by the uninitiated.

**SECONDLY.**—We take your old apparatus in part exchange for new. Send us a list of your old apparatus, or, better still, send us the apparatus, and state your new requirement. We will then make our offer for your goods, and if you do not approve, which is unlikely, we will return the parcel, carriage paid.

**If You are in Doubt as to the Make of Receiver or other Apparatus you should purchase, write to us, and we will advise you; we have no leaning towards any particular maker, and will tell you the particular instrument you should buy for your purpose.**

**SCIENTIFIC DEVELOPMENT Co.**, 51, Fishergate, Preston. Tel.: 1364. [0226]

**FOR Sale.**—Four 3-valve receivers, equal to the best and guaranteed, complete, and ready to switch on; 55/- each; many other bargains.—Enquiries to Adams, 48, Tyrwhitt Rd., London, S.E.4. [7868]

**MARCONIPHONE** All Mains 3-valve Set 37, used one month, reason, changing to A.C., as new; cost £12/7/6, take £9 or offer.—Box 4430, c/o The Wireless World. [7857]

**EKCO** 3-valve All Mains Set, A.C., 200-250v., as new; £14; seen by appointment.—K. Rice-Axley, 55, Argyl Rd., Kensington. Tel.: Western 6176. [7852]

Mention of "The Wireless World" when writing to advertisers will ensure prompt attention.

Receivers for Sale.—Contd.

**F**OR Sale.—G.E.C. 8-valve set, superhet, indoor aerial, Exide batteries for H.T.; best offer accepted.—Apply 217, Gunnersbury Lane, W.5. [7837]

**5-VALVE** Pada Neutrodyne (switch, 4 valves), 5 Mullard valves, H.T. battery, accumulator, and loud-speaker, £9; wanted part exchange, good portable gramophone and small billiard table complete.—E., 75, Heath St., Hampstead, N.W.3. [7849]

**EUROPA** Portable, with cabinet, less wiring, H.F. transformers, speaker and valves.—Enquiries to W. H. Sadler, Ottery St. Mary. [7842]

**SIMMONDS BROS.**—Receivers constructed to your own or any published design; also repairs, reconstructions; and modernisations at moderate charges; best materials and workmanship guaranteed; numerous testimonials; quotations free.—Address, Shireland Rd., Smethwick. [5882]

**SUIT** Beginner.—2-valve Brownie, complete coils (B.C.C., 5XX), valves and rod accumulator; £4.—Behr, 2, Birch Grove, Lee, S.E.12. [7922]

**2-VALVE** Burndep, complete with L.S. and 3 B.T.H. headphones, good working order; £2/15, or offer.—Box 4447, c/o *The Wireless World*. [7910]

**KILO-MAG** 4-valve Receiver, exact specification, powerful, valves, loud-speaker; bargain, quick sale, £10; heard evenings 8 p.m.—Lynch, 2, Alvanley Rd., West Derby, Liverpool. [7900]

**MARCONI** Straight Eight, complete with A.C. high tension eliminator, cv. accumulator and Tunar charger, in perfect condition; £25.—A. Southgate, 79, Rochester Row, Victoria, S.W.1. Tel.: Victoria 4361. [7895]

**SELECTIVITY**, Freed-Eisemann 5-valve Neutrodyne, model N.R.6, new Osram valves, fine reproduction 40 stations recently range 200-600 metres, suitable London district; £12.—Postlethwaite Bros., Kinver, Stourbridge. [7886]

**McMICHAEL** 7-valve Superhet., complete with frame aerial, Amphion mahogany Radiolux (large), batteries, accumulators, and 10 spare valves; £20, cost over £70; seen after 7.—23, Englewood Rd., Clapham Common, S.W.12. [7884]

**ALL-MAINS (A.C.)** 3-valve Set, new; £15.—6, Hauberk, Rd., S.W.11. [7881]

**APPLEBY'S.**

**APPLEBY'S** Bargains.

**T**HE Following Slightly Used Material is Offered subject to sale; every article will be severely tested before despatch, and guaranteed in workable condition; the following items quoted are nett cash and carriage paid in Great Britain:—

**RESIDUE** of Receivers.—One only left, McMichael Screened Dimic Three receiver, in oak, with set of three tested valves, as new, £10/15; one only left, Geophone Superhet. receiver, complete with set tested valves and frame aerial, condition perfect, £12/15; one only left, Marconi 5-valve portable receiver, complete, £13/10; one only left, Aeonie 5 valve portable receiver, complete, £8/10; one only, Geophone 3-valve S. wave receiver, condition perfect, £7/10.

**NOW**—Send now; many clients were disappointed by material having been sold previous to their application, for sets advertised a week or so ago.

**APPLEBY'S**, Number Forty-four Chapel St., Marylebone, N.W.1 (four minutes from Oxford St., London). [031]

**PYE** Portable, as brand new, £17/10; Magnavox moving coil speaker, 6 volts direct current, 65/-.—105, Chatsworth Rd., N.W.2. [7853]

**SOLODYNE**, handsome oak case, Cydon triple gang, Lewcos long and short wave, 5 Osram valves, filter circuit, Pye transformer.—Cordingley, Hebden Rd., Grassington, Skipton, Yorks. [7889]

**MULLARD** Columbus Set, Cydon condensers, 5 Mullard valves, Colvern high and short wave; £6/10.—Cordingley, Hebden Rd., Grassington, Skipton. [7890]

**MULLARD** Portable, all parts as specified, Exide accumulator; £7/10.—Cordingley, Hebden Rd., Grassington, Skipton. [7892]

**MARCONI** Model 61, 6 valves (3 S.G., 2 L.F.), extremely powerful and selective, perfect condition; cost £60, bargain; write best offer.—Box 4452, c/o *The Wireless World*. [7920]

**ACCUMULATOR HIRE.**

**DON'T** Buy Accumulators or Dry Batteries, join our C.A.V. low- and high-tension accumulator hire service, the largest and best in London; better and cheaper reception with no trouble; regular deliveries within 12 miles of Charing Cross; no deposit, payment on delivery or by subscription; over 10,000 satisfied users; explanatory folder post free; phone or write to-day.—Radio Service (London), Ltd., 105, Torrington Av., N.W.5. Phone: North 0623-45. [7596]

**C.D.E.S.** Accumulator Hire and Maintenance Service (5 mile radius)—98, Cherry Orchard Rd., Croydon. [6374]

*The finest Loudspeakers in the world in their class*

**EPOCH**  
Moving Coil Speakers.

Models 99 and 66 are the standard of comparison in many of the famous laboratories of the world. The speakers that have made Radio as enjoyable as the best concerts. 14 different models for all requirements, from £2 10 0 upwards.

Write for Booklet W.S. giving full particulars and the 7 days free trial offer.

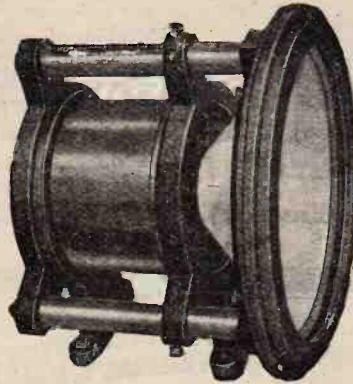

*Our Latest Triumph!*  
**Epoch**  
**Super-Cinema Model**

The most powerful speaker ever put on the market, and the most sensitive too! Many times as sensitive as an ordinary moving-coil speaker. Such superb quality has never been heard before. Delivers enormous volume and wonderful quality from the most modest of sets. The speaker for the home, public entertainments or Talkies!

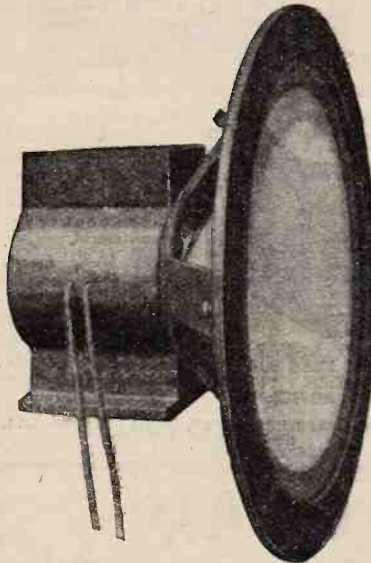

**EPOCH RADIO MANUFACTURING CO., LTD.,**  
are the manufacturers.

City Office & Service Station: 3, Farringdon Avenue (Ludgate Circus end), E.C.4

Phone: Central 1971 (2 lines); Private Branch Exchange.

**BATTERIES.**

**WET** H.T. Replacements.—Sacs (capped or uncapped), highest grade, No. 1, 10d. per doz.; No. 2, 1/9 per doz.—See below.

**ZINCS**—Best quality (wired), No. 1, 8d. per doz.; No. 2, 9d. per doz.; orders valued 5/- carriage paid, otherwise 6d. for postage.—British Battery Co., Clarendon Rd., Watford, Herts. [0254]

**PENTODE** Users.—Write for details of new size self-charging wet battery; 20,000 milliamps, 6d. per volt; illustrated catalogue giving data, post free.—U. Taylor, 57, Studley Rd., Stockwell, London. [0273]

**WET** H.T. Batteries.—Parts per dozen, jars, No. 1, 2 1/4 x 1 1/2 square, 1/3; No. 2, 1/5; zincs, No. 1, 10d.; No. 2, 11d.; sacs, No. 1, 1/2 dozen; No. 2, 1/9; terminals, 8d., 10d.; dozen cells (18 volts), complete with bands and electrolyte, No. 1, 4/1; No. 2, 5/-; post 9d.; high efficiency, long life, self charging, upkeep small; send 6d. for sample unit; illustrated booklet free, carriage free order 10/-; write for free list wireless bargains, trade supplied.—W. Taylor, 57, Studley Rd., Stockwell, London. [0039]

**CHARGERS AND ELIMINATORS.**

**VORTEXION** Transformers, chokes, etc., for want to any specification; write or phone for quotation; best quality components only.—Vortexion, 72, Merton Rd., Wimbledon, S.W.19. Tel.: Wimbledon 2814. [0319]

**TANTALUM** and Lonium for A.O. Rectifiers; make up your own inexpensive chargers; blue prints for H.T. and L.T. 1/- each, Lonium electrodes fitted with terminals, 2-3 amps. and 5-8 amps.—Blackwell's Metallurgical Works, Ltd., Speke Rd. Works, Garston, Liverpool. Phone: Garston 980 (2 lines). [6282]

**PHILIPSON'S** Safety High Tension Battery Eliminators.

**10/-** Down and the Balance in Easy Monthly payments secures the finest high tension supply available.

**PHILIPSON'S** Safety Eliminators are Guaranteed for 12 Months.

**PHILIPSON'S** Safety Eliminators are the Cheapest to Install and the Cheapest to Run; prices: Model A.C.5 £4/17/6, A.C.7 £3/17/6, complete with full wave, rectifiers; D.C.4 3/7/6, D.C.5 4/5/-.

**ALL** Models Obtained for 10/- Deposit; take advantage of this and get constant high tension immediately.

**WRITE** for Our Booklet, "Radio Power" to Philipson and Co., Ltd., Radio Engineers, Astley Bridge, Bolton. Phone: 2038. Grams: Safety, Bolton. Est. over 50 years. [0318]

**CHEBROS**—Chebros for all types of transformers and chokes, high grade instruments at a very moderate price; enquiries invited.—Chester Bros., 244, Dalston Lane, London, E.8. [5290]

**TRANSFORMERS** and Chokes for Battery Eliminators and for all wireless purposes, receiving or transmitting; enquiries invited.—Chester Bros., 244, Dalston Lane, London, E.8. [7587]

**FEL-ECTRIO** High Tension Eliminator Kits, improved output 15 milliamps at 120 volts; complete; 25/-.

**FEL-ECTRIO** Eliminator Kits are the Best and cheapest in England; complete, 25/-.

**FEL-ECTRIO** Kits are Complete, except valve, and we recommend Philips 373; 15/-.

**FEL-ECTRIO** Kits have been Sold in Hundreds, and are guaranteed, satisfaction or money returned.

**FEL-ECTRIC** Kit will be sent c.o.d. if desired, state voltage and periods, also whether Philips valve is required at 15/- extra.

**FEL-ECTRIC** Eliminator Kit is Post Free; price 25/-.

**FOLDER** and Lists on Request to Fel-Ectric Radio, 56, Garden St., Sheffield. [7742]

**SAVAGE'S** Specialise in Wireless Power from the Mains, reliable apparatus at reasonable prices.

**SAVAGE'S** Transformer Laminations and Bakelite Bobbins; intending home constructors should write for list.

**SAVAGE'S** Reliable Smoothing Condensers.—1,000 volts D.C. test, 2 mid. 3/1, 4 mid. 5/3; 500 volts D.C. test, 1 mid. 1/6, 2 mid. 2/3, 4 mid. 3/9.

**SAVAGE'S** Super Smoothing and Output Chokes.—Many types available, write for list.

**SAVAGE'S** Mains Transformer for Westinghouse Rectifiers.—H.T.4, 18/6; A.3, 17/-; A.4, 20/-.

**SAVAGE'S** Mains Transformer for Westinghouse S.H.T.4 Unit, with additional winding, 4 volts 3 amps.; 23/-.

**SAVAGE'S** Mains Transformer.—V.T.31, 200-0-200 volts 60 m.amps. 2+2 volts 2 amps., 2+2 volts 3 amps.; 28/-.

**SAVAGE'S** Mains Transformer.—B.T.3 500-0-500 volts 120 m.amps., 3.75+3.75 volts 3 amps., 3+3 volts 3 amps., 2+2 volts 3 amps.; 51/-.

**SAVAGE'S** Mains Transformers and Power Chokes are carefully and individually constructed from first class materials with an exceptionally generous margin of safety.

**SAVAGE'S**, 146, Bishopsgate, London, E.C.2. Phone: Bishopsgate 6998. [6808]

**Chargers and Eliminators.—Contd.**

**TANALUM Strip for Rectifiers;** 4/- per square inch.—C. L. James, 17, Brunswick St., Liverpool. [7864]

**CRYPTO A.C. to D.C. Converter, A.C. input 200-250 volts 50 cycles, D.C. output 75 watts up to 15 volts;** price, complete with switchboard fitted with ammeter, Zenith resistance, switches, fuses, etc. £7/10, list price £11/15 without switchboard; condition as new; can be seen running.—Durriz, 11, Montagu Gardens, Wallington, Surrey. [7872]

**A.C.110. Ekco Eliminator, 220 volts 45m.a., tapped 110, £2/10;** also D.O. eliminator, any voltage, £1/10.—Snow, 3, Kensington Gate, W.B. [7839]

**MARCONIPHONE All Power Unit, D.C.1, 240-200-volts.—**Cordingley, Hobden Rd., Grassington, Skipton. [7891]

**CABINETS.**

**ARTCRAFT Radio Cabinets** are Britain's Best Value. [0313]

**DIGBY'S Cabinets.—**Table models in solid oak and mahogany; from 11/6 to 71/-.

**DIGBY'S Cabinets, fitted with Radion or Resiston** ebonite if required.

**DIGBY'S Cabinets.—**Pedestal model, with separate battery components; from 56/- to £12.

**DIGBY'S Cabinets Made to Customer's Own Designs.**

**DIGBY'S Cabinets.—**Write for new 16-page art catalogue.—F. Digby, 9, The Oval, Hackney Rd., E.2. 'Phone: Bishopsgate 6453. [0128]

**ARTCRAFT Radio Cabinets;** Britain's best value; lowest prices consistent with highest quality; illustrated list free from actual manufacturers.—Artcraft Co., 156, Cherry Orchard Rd., Croydon. 'Phone: Croydon 1981. [0040]

**CABINETS, 16½in. x 7½in. x 11in.,** hand mahogany finished 7/6, unpolished 5/6; oval front, 10½in. x 6½in., 6d. extra; portable cabinets, 16½in. x 16½in. x 8in., £1/5; baseboard, 6d.; carriage free.—F. W. Ramsey, 63, Shaftesbury St., London, N.1. Clerkenwell 7139. [7584]

**ARTCRAFT Radio Cabinets** are Britain's Best Value. [0311]

**KAY'S Cabinets,** the greatest range of pedestal cabinets in the kingdom; original creative designs at prices 50% lower than elsewhere; quotations for specials by return; delivery at short notice guaranteed; moving coil, portable, baffie, vignette, radiogram, electric, pick-up, television, etc.; illustrated lists free.—H. Kay, Wireless Cabinet Manufacturer, Mount Pleasant Rd., London, N.17. 'Phone: Walthamstow 1626. [7745]

**ARTCRAFT Radio Cabinets** are Britain's Best Value. [0310]

**A CONE Speaker Cabinet of Distinction.—**Solid selected figured oak fret and case, 12in. x 12in. x 5½in. inside extra strong 6 mm. plywood back for fixing unit, rubber feet or baize, state which, polished rich dark oak, unless otherwise ordered, 8/9 each, carriage paid; unpolished, but quite ready for staining and polishing, 7/6 each, carriage paid.—Manufacturer, W. T. Tucker, 2, Vincent St., Balsall Heath, Birmingham. 'Phone Calthorpe 2435. [7850]

**ARTCRAFT Radio Cabinets** are Britain's Best Value. [0309]

**TRANSPORTABLE Oak Cabinet,** frame aerial fitting, loud-speaker, chassis and unit, practically new; 35/-.—'Wyncoot,' South Oak Lane, Wimslow, Manchester. [7911]

**COILS, TRANSFORMERS, ETC.**

**NEW Kilo-Mag Four Coils, 37/6 set;** ebonite formers (slotted), for winding, 12/6 set of 3; all post free; trade supplied.—Groves Bros., St. Mary's Place, Shrewsbury. [7750]

**1,000-OHM Decoupling Resistances** for "Wireless World" Circuits; 1/6 each, post free.—Groves Bros., St. Mary's Place, Shrewsbury. [7833]

**SIMMONDS BROS.—**Berdif coils, Record Three, 50/- pair; new kilo-mag. four, 50/- set; foreign listeners four, low, 30/-; long wave, 37/-; screened grid Regional, 40/-; Mullard S.G.P. dual range coils, 30/- pair; Berdif standard coils, for new all-wave four, standard four, A.C. three, Everyman four, etc., 63/6 set of 4, with bases; the same coils for the Lodestone series ("Wireless Magazine"), 65/9 set of 4, with bases; Titan unit, 15/-; decoupling resistances, 600 ohm, 1/6; 1,000 ohm, 2/-; all "Wireless World" and similar coils in regular production by the leading specialists; list free; trade supplied.—Simmonds Bros., Shireland Rd., Smethwick. Tel.: Smethwick 751. [6314]

**RADIOGRAPH.—**W.W. coils, Record III, 35/-; new Kilo-Mag Four, 33/-; S.G. Regional, 37/6; foreign listeners' Four, 37/6 set; Europa Portable, 21/-; Europa III, 18/6; S.G. multi-valve portable, 22/6; new Everyman Four, 42/6.

**RADIOGRAPH.—**Litz wire, 9/40, 1/6; 27/42, 2/6 dozen yards; Redfern's deep ribbed or Beool tube, 5d. per inch, slotting 1/6 extra.—Station Rd., Handsworth, Birmingham. [7914]

**KUSHETTE PICK-UP ARM**

A new Arm for Radio-Gramophones; functions perfectly, and is more efficient than a cheap tone arm. Suitable for use with existing Tone Arms to avoid removal of Sound Box.



Price 5'9

Weight-relieving—adjustable. Lifts out from base: correctly angled for best alignment; bushed bearing; no vibration; well finished in aluminium.

Through G.E.C., all best Factors, or direct from

R. H. Glascoe & Co., 71, Moorgate, E.C.2.

'Phone: Lon. Wall 1176.

**THE WANDER PLUG WITH THE POWERFUL GRIP**

Look at its prongs of special spring-metal that grip the socket—its insulated holder—the neat engravings on the head—its finish. Replace your old wander plugs with Belling-Lee to-day, and put an end to bad contacts and loose plugs.



4d.

Ask your dealer, or send to us, for Belling-Lee Handbook "Radio Connections."

P. Pat.

**BELLING-LEE FOR EVERY RADIO CONNECTION**

Advertisement of Belling and Lee, Ltd., Queensway Works, Ponders End, Middlesex.

Our 1930 Super Power Model.

**"GO HOME AND LISTEN."**

Definitely proved by independent laboratory tests to be the most efficient moving coil Loud Speaker yet manufactured.

"The Music Lover's choice."

**BAKER'S "selhurst" RADIO**

SEND TO-DAY FOR OUR FREE 36-PAGE BOOKLET "SOUND ADVICE."

Offices: 89 SELHURST ROAD, SOUTH NORWOOD, S.E.25. Works and Demonstration Room: 42 CHERRY ORCHARD ROAD, EAST CROYDON.

**POLAR**

THE MODERN CONDENSER FOR MODERN CONDITIONS



**Coils, Transformers, Etc.—Contd.**

**600-OHM Decoupling Resistances** for New Kilo-Mag Four, foreign listeners' four, and all "Wireless World" circuits, hand made and tested in our own workshops; improved model, 1/6 each, post free.—Groves Bros., St. Mary's Place, Shrewsbury. [7832]

**GRAMOPHONE PICK-UPS, ETC.**

**ELECTRIC Pick-up,** with arm, adaptable to any gramophone; pick-up 14/-, arm 7/-; c.o.d.; remarkable value.—G. Hodgson, 53, Windsor House, Victoria St., Westminster. [7738]

**R.I. Varley Pick-up,** practically unused; 22/6.—Snow, 3, Kensington Gate, W.8. [7839]

**CELESTION Woodroffe Pick-up,** cost £4/4, absolutely as new; £2/10.—Box 4448, c/o The Wireless World. [7909]

**B.T.H. Pick-up,** almost new; 45/-, will sell 32/6.—J. Mullen, 158, Crosslet Rd., Dumbarton. [7923]

**LOUD-SPEAKERS.**

**6-VOLT ¼ amp. M.O. Speaker,** list £6, new last year, in perfect order, including transformer; 29/6; 7 days' approval against cash.—Brew, Pytchley, Kettering. [7845]

**200-250 Volt D.C. Mains Moving Coil Speaker,** almost new, 29/6; also Zampa double cone chassis, new, cost 32/6, 15/-; 7 days' approval against cash.—Fox, 115, Avondale Rd., Kettering. [7844]

**OAK Cabinet, fret front, blue-silver cone,** new double pole unit; 25/-; 14x13x9.—Kirkup, Fairholme Rd., Burnley, Lancs. [7856]

**AMPLION, oak horn, 120 ohms;** what offers?—Woodroffe, Thorn Cottage, Southwell, Notts. [7861]

**GREAT Bargains**

**GREAT Bargains**

**GREAT Bargains.—**Epoch model A moving coil speaker kit (or complete units), brand new; a large number of these famous instruments made for a special order for use in talkies, but not executed, for credit reasons only; regular prices, £3/10, £4/2, and £5/17/6, to clear at 50/- for accumulator operation, 55/- for D.C. mains operation, 85/- for A.C. mains; kits comprising copper plated super magnet-pot (weight 23 lb.), Chrystalene frame, fully adjustable, moving coil, any impedance, paper, leather and mounting rings, made up complete, if desired, 6/- extra.

**GREAT Bargains**

**GREAT Bargains.—**In fact, the greatest bargains ever offered! A number of Epoch model A used kits at given away prices, guaranteed in perfect working order; early 1928 model, 35/-; latest model, 42/6; made up complete, if desired, 6/- extra.

**ENJOY Marvellous Epoch Reproduction** at Ridiculous Cost; don't wait until they are all gone, but secure one immediately by writing, phoning, telegraphing, or hurrying to Epoch, 3, Farringdon Av., E.C.4 [7077]

**EPOCH**

**EPOCH Speakers** by Deferred payments.

**EPOCH**

**EPOCH Speakers** by Deferred payments.

**EPOCH**

**EPOCH Famous Moving Coil Speakers,** any type, may be obtained by any responsible householder, by easy payments; no interest, no references no red tape as simple, easy and quick as paying cash.

**EPOCH**

**EPOCH on the Easy.—**Full particulars from Laser-son, Ltd., Gramol House, Farringdon Avenue, E.C.4. [7919]

**B.T.H. R.K. Senior, 200-230-volt D.C. mains amplifier,** complete with two PX650 valves; £20.—Box 4446, c/o The Wireless World. [7908]

**GOODMANS Annual Stocktaking Bargains.**

**POT Magnets.—**Solid cast annealed steel, the finest made; remains of special order; complete with brass bobbin, unbound; 27/6 each; ideal for demonstration or high power work.

**MOVING Coil Speaker Cabinets,** solid mahogany, oak or walnut veneer, very slightly soiled; 27/6, usually from £2/2.

**VARIOUS Makes of Units,** moving coil speakers and pick-ups, used for test purposes; send us your enquiry.

**GOODMANS, 27, Farringdon St., E.C.** [7906]

**AMPLION Dragon;** first 25/- secures.—F. Caddick, 15, Stanley Park Rd., Wallington. [7888]

**GET Moving Coil Quality,** double linen speaker, 20in. square, 25/-; polished mahogany 17/- ply case, fit any unit.—Parke Radiograms, 79G, Turnpike Lane, N.8. [7887]

Mention of "The Wireless World," when writing to advertisers, will ensure prompt attention.





Only Brownie's huge production enables them to offer this really splendid dial for 2/6. The special non-backlash design makes hair-breadth tuning a matter of delightful ease, while its handsome appearance (black or beautifully grained mahogany bakelite) will add to the good looks of that new set you are building.

BROWNIE WIRELESS COMPANY (G.B.) LIMITED, NELSON STREET WORKS, LONDON, N.W.1.

**BROWNIE**  
WIRELESS

—a tone-perfect production  
—a friend of good Records!



Scientifically designed, beautifully made, The MELTROPE Sound Box gives perfect tone and wonderful service, and will bring the oldest gramophone up to date!

Price 12/6.

Made by  
**AMPLIFIERS LTD.,**  
BILLET ROAD, LONDON, E.17.

Suitable for all types of tone arm.

Loud-speakers.—Contd.

BAKER'S

BAKER'S

SELHURST RADIO.—Go home and listen to Baker's super power moving coil loud-speakers.

BAKER'S

SELHURST RADIO.—Go home and listen to the most efficient moving coil speaker yet manufactured.

BAKER'S

SELHURST RADIO.—Go home and listen to its wonderful realistic reproduction.

BAKER'S

SELHURST RADIO.—Go home and listen to believe.

BAKER'S

SELHURST RADIO.—Go home and listen and take your friends.

BAKER'S

SELHURST RADIO.—Go home and listen, but first write for our 36-page booklet, "Sound Advice."

BAKER'S

SELHURST RADIO.—Go home and listen. "Sound Advice," new issue just published.

BAKER'S

SELHURST RADIO.—Go home and listen, or come to our demonstration room, 42, Cherry Orchard Rd., Croydon.

BAKER'S

SELHURST RADIO, the leading manufacturers of high grade moving coil loud-speakers.

OFFICE: 89, Selhurst Rd., South Norwood, S.E.25.  
Phone: Croydon 1618. Works and Demonstration Room (always open): 42, Cherry Orchard Rd., East Croydon (15 minutes non-stop Victoria or London Bridge). [0231]

**NEW LIFE TO SETS... OLD OR NEW**

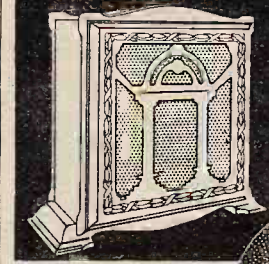

from  
**£3/19/6**

Sold in all radio shops. If out of stock send dealer's name and address to us.

Ideal acoustic conditions for the natural reproduction of broadcast music, speech and song exclusive to factory-made Double Linen Diaphragm Speaker. Small diaphragm for high, large diaphragm for low audible frequencies. Accurately balanced for area, juxtaposition and mutual tension. Hear it at your dealer's. Available in five models from £3-19-6.

ULTRA ELECTRIC LIMITED  
661-663, Harrow Road, London, N.W.10



Baldry Ad. U137.

for SMOOTH RECEPTION  
**"Layerbilt"**

The "Layerbilt" is unbeatable for smooth reception. It is crammed full of electricity and lasts half as long again as any other battery of the same size and weight in the world. This is assured by the Columbia patented process of building layer upon layer of Fat cells. The "Layerbilt" Heavy Duty Battery is the best and most economical battery in the world. Use it always.

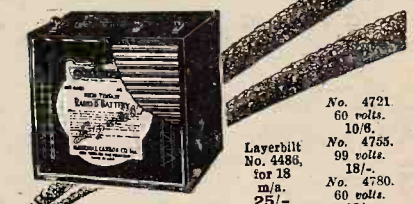

No. 4721	60 volts.
	10/8.
No. 4755.	99 volts.
	18/-.
Layerbilt No. 4486, for 18 m/a.	No. 4780. 60 volts.
	25/-.

**Columbia RADIO BATTERIES**

J. R. MORRIS, Imperial House, 15, Kingsway, London, W.C.2.  
Scotland: J. T. Cartwright, 3, Cadogan St., Glasgow.

**APPLICATIONS**  
invited for  
**POSITIONS AS REPRESENTATIVES**  
by  
**TELSEN ELECTRIC CO. LTD.**

The positions are for whole time, and salary, commission and expenses will be paid.

Applications must state full detailed experience during the last seven years, age, number of years experience in car driving and remuneration required, also the particular area or district preferred, or, where best known.

Only first-class men with good references need apply.

All applications will be treated with strict confidence.

**TELSEN ELECTRIC CO. LTD.**  
Miller Street, BIRMINGHAM.

**RADIO-GRAMOPHONE**  
**CABINETS**

Beautifully finished in highly polished OAK.

Will take sets  
18" x 7" x 16" or 21" x 7" x 16".  
Spacious compartment for speaker and batteries. Overall size 36" x 24" x 19".  
9-ply motor board.

£4-19-6

(Mahogany Finish £5-15-0.)  
Delivered free in England and Wales: Scotland 2/6 extra.

Send for our Illus. Catalogue.  
Fitted complete with D.S. Motor, B.T.H. Pick-up and Arm, Ormond Unit and Chassis. . . . . **£9-17-6**

This is all you need to turn your present set into a modern **RADIO-GRAMOPHONE.**

**PREMIER SUPPLY STORES**  
Radio & Gramophone Specialists,  
165, Fleet St., London, E.C.4.

Phone: Central 2833

Large selection of Gramo. Motors and Pick-ups always in stock

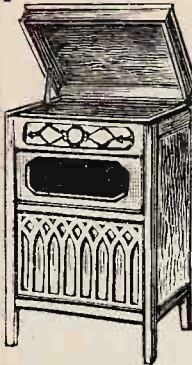

**"B.A.T." 750 Watt**  
**"Q.M.B." SWITCH.**

This miniature switch comfortably breaks 8 Amperes at 250 Volts. For H.F., L.F., H.P., L.T. Circuits. For A.C. Sets, Eliminators, Gramo-Motors, and as Loud Speaker Field Switch, etc.

"WIRELESS WORLD" said (14.8.29) "functioned quite well on test and did not give any cause to justify doubt as to their ability to handle this wattage" (750 Watts!). "Ideal for use in portable sets and in all types of mains equipment."

"B.A.T." "Q.M.B." POWER SWITCH only 2/6 Each.



**CLAUDE LYONS LTD.,**  
76, OLDHALL STREET, LIVERPOOL.

**MISCELLANEOUS.**

**A**LEXANDER BLACK.

**P**LEASE Note New Address.

**T**HE Original Wireless Doctor, will call (London and Home Counties) and cure your set.

**C**ONSULTATIONS by Appointment Without Obligation, sets installed, maintained, and brought up to date, gramophone pick-ups, eliminators, and Webson moving coil speakers demonstrated, purity reproduction specialist.

**55**, Ebury St., Victoria, S.W.1. Sloane 1655. [0277]

**E**ASY Payments.—We supply, by easy payments, components, accessories, and sets, any make; 10% down, balance spread over 10 months.—Send list of requirements to London Radio Supply Co., 11, Oat Lane, London, E.C.2. [0097]

**W**IRELESS Notes.—A monthly service of information for all those who want the very best in wireless or gramophone reproduction; frank criticism of receivers and components; immediate postal help and advice in all difficulties; something new and unique; you must have it if you want to know the truth.—Full particulars free from Ernest H. Robinson, Langmead, Pirbright, Woking, Surrey. [7607]

**S**COTT SESSIONS and Co., Great Britain's radio doctors, officially approved as wireless repairers by Radio Society of Great Britain and Wireless League; old sets of every type repaired, rebuilt, modernised; send set for immediate quotation.

**S**COTT SESSIONS and Co.—New sets constructed with your or our components, guaranteed finest workmanship; we specialise in "The Wireless World" circuits; remember, we have satisfied customers throughout the British Isles and in three Continents; if you so desire, we will design and construct high grade apparatus to suit your special circumstances for quality, range and selectivity.—Tel.: Tudor 5326. Muswell Hill, London, N.10. [0262]

**H**AVE Your Set Brought Up to Date, be able to separate Brookmans transmissions, cost 35/-; all mains sets installed from £12/10; whatever your requirements drop a card, all work guaranteed by expert.—Lee, 48, Eaton Park Rd., London, N.13. [7912]

**PATENT AGENTS.**

**P**ATENTS and Trade Marks, British and foreign.—Gee and Co. (H. T. P. Gee, Member R.S.G.B. and A.M.I.E.E.), 51-52, Chancery Lane, London, W.C.2. Phone: Holborn 1525. [0001]

**REPAIRS.**

**T**WELVE Months' Guarantee Accompanies all our Repairs; any make of L.F. transformer, headphones, or loud-speaker repaired and despatched within 48 hours; 4/- post free; don't discard if burnt out; terms to trade.—Transformer Repair Co., (Dept. W.), 214, High St., Colliers Wood, S.W.19. [0011]

**S**COTT SESSIONS and Co., Great Britain's radio doctors; read advertisement under Miscellaneous column. [0263]

**R**EPAIRS Returned Post Free, and to ensure satisfaction send remittance after approval of same.—Leeds Wireless Repair Service.

**L**OUD-SPEAKERS, headphones, re-wound to any resistance and remagnetised. 3/- transformers re-wound, 4/-; Blue Spots, Triotrons and 4-pole units, 4/6; work guaranteed.—Leeds Wireless Repair Service, 5, Boston Place, Green Rd., Leeds. [7652]

**E**FFICIENT Repairs, attractive maintenance service; consultations by appointment, no obligation.—Bolton, 221, Cavendish Rd., Balham. [7899]

**G**UARANTEED Repairs by Experts.—Loud speakers, headphones, cone units, pick-ups, any type, re-wound, remagnetised, and adjusted, post free 4/-; transformers, from 4/-.—Howell, 91, Morley Hill, Enfield, Middlesex. [7882]

**WANTED.**

**T**HREE Marconiphone Intermediate Transformers, tuned 6-500 metres.—Glanville, 129, Love Lane, Mitcham. [7865]

**W**ANTED, "The Wireless World," issue October 24th, 1928, clean and intact; will give 2/-.—Brook, 43, St. James's Av., Hampton Hill, Middlesex. [7870]

**Y**OUNG Radio Engineer Requires get in Touch with Firm or School for Further Practical and Theoretical Experience of talkie amplifiers and sound reproduction; premium if necessary.—Box 4439, c/o The Wireless World. [7879]

**W**ANTED, Philips 4-valve all mains set.—Pelly, Pierhead, Eastbourne. [7836]

**F**ERRANTI A.F.5, 20 henry filter choke, Blue Spot 66K unit, wire wound resistance, 150,000 ohms, potentiometer, 1 meg.—Write Hoare, 20, Aberdeen Park, N.5. [7907]

**So Many**  
**Replies!**

A recent advertiser in "THE WIRELESS WORLD" writes as follows:

"I HAVE received so many replies to my advertisement in 'The Wireless World,' which appeared under a Box Number that I am sending herewith stamps to the value of 6d. as further payment towards your postage expenses. Thanking you for the quick despatch of all replies."

R. W. CAPEWELL,  
52, Chapel Terrace,  
Trent Vale,  
Stoke-on-Trent.

W.W.88.

**STUPENDOUS!**

A recent advertiser in "THE WIRELESS WORLD" writes as follows:

"As the results from my advertisement in 'The Wireless World' were stupendous, I shall be glad if you will cancel my advertisement in next week's issue as I am cleared out.

I might add that 'The Wireless World' is the best journal I have read."

W. F. Macbeth,  
"Bræmar,"  
Ballymena, Ulster.

w.w.89.

**Wanted.—Contd.**

**WANTED**, Mullard Orgola S.G.P., Ferranti S.G.3 parts, Lotus remote control, A.F.5C, O.P.M.3C, recent model 6-volt M.C. speaker.—C.W.D., "Craignair," Lonsdale Av., Davyhulme, Manchester. [7883]

**EXCHANGE.**

**IGRANIC** Pick-up, exchange Orgola coils or cone unit.—Price, South View, Chester-le-Street. [7863]

**EXCHANGE** 14-guinea Royal Portable Typewriter, perfect condition, for music magnet (or similar set) plus accessories.—Didsbury 1113. [7848]

**YOUR** Old Apparatus Taken in Part Payment for Latest Type; see our advert in column Receivers for Sale.—Scientific Development Co., 51, Fishergate, Preston. [0250]

**AGENCIES.**

**REPRESENTATIVES** Required to carry well advertised Proprietary Lines, commanding quick sale on commission basis only, for West and N.W. London, Eastern Counties, Yorkshire, Lincoln, North Wales and Cheshire, South Wales, S.W. England; must have good connection.—Write Box 4433, c/o *The Wireless World*. [7859]

**FINANCIAL PARTNERSHIPS.**

**PROGRESSIVE** Wireless Business, turnover over £2,000 per annum, South West England; living accommodation; low rent; £250.—Box 4445, c/o *The Wireless World*. [7904]

**SITUATIONS VACANT.**

**WANTED** by Manufacturers (S.E. Essex), wireless mechanic, with practical experience in all branches of A.C. radio; only applications giving (in confidence) fullest details of past experience and wages required, will be considered.—Box 4431, c/o *The Wireless World*. [7858]

**LISSEN, Ltd.**, require a development engineer for their valve department; applicants should possess sound technical knowledge and have experience in valve manufacture.—Reply in confidence, stating experience, age and salary required, to Valve, c/o Bernard Smith Advertising Service, Ltd., British Columbia House, 1-3, Regent St., London, S.W.1. [7847]

**TRAVELLER** for London and district Wanted by Well Known Manufacturers, one having a motor car will be preferred; arrangements might be considered as a part job on a commission basis; give full details of experience, salary required, make of car, knowledge of wireless, the latter, while an advantage is not essential.—Box 4449, c/o *The Wireless World*. [7918]

**BUSINESSES & PROPERTY FOR SALE, TO BE LET, OR WANTED.**

**ADVERTISER**, with thorough technical knowledge, requires working interest in established radio and electrical concern, where additional capital is required to expand the business.—Write Box 4436, c/o *The Wireless World*. [7876]

**BOOKS, INSTRUCTION, ETC.**

**WET H.T. Batteries** are now a proved success; write for new illustrated booklet, giving cost and method of building and maintaining free; mention paper.—Taylor, 57, Studley Rd., Stockwell, London. [0077]

**Convert your present Set into a Short Wave Receiver.**



**Magnum Short Wave Converter.**

This Converter is adaptable to any valve set by simply removing the detector valve from set and inserting it in the valvoholder of converter, the plug of converter taking the place of the detector valve. In crystalline metal cabinet, with 2 Coils 20/40 and 40/80 metres. Plug and Adaptor £4.10.0 inclusive.



**Universal Three 15-2,000 metres.**

The most perfect receiver yet designed for Ultra Short Wave, Broadcast, and Long Wave reception. Including Valves, Coils and Royalty £18:0:0.

Magnum Receivers are now obtainable on Easy Payment Terms.

We specialise in all apparatus described in "Wireless World."

Lists on application.

**BURNE-JONES & Co., LTD.**

295, BOROUGH HIGH ST., LONDON, S.E.1.

**Books Instruction, Etc.—Contd.**

**STEP** by Step Wireless; a complete course of the theory of electricity in relation to the practical design of wireless apparatus, eliminators, circuits, etc., with extracts from a designer's notebook, giving up-to-date practical application; issued weekly; send 1/- p.o. for first 4 weeks.—Clifford Pressland, A.M.I.E.E. Eng., Dept. W.W., Hampton-on-Thames. [0195]

**FREE:** Inventor's Guide on Patents.—T. A. A., 253 (W). Gray's Inn Rd., London, W.C.1. [6373]

**A GUIDE** for the Crystal User.—"Successful Crystal and One-valve Circuits," by J. H. Watkins, tells you how to improve the performance of your receiver and gives diagrams of many well-tested circuits; 3/6 net, of booksellers, or Pitman's, Parker St., Kingsway, London, W.C.2. [7070]

**PORTSMOUTH MUNICIPAL COLLEGE.**

Principal: L. B. Benny, M.A.

**ELECTRICAL ENGINEERING DEPARTMENT.**

Radio Telegraphy Section.

Required IMMEDIATELY, a Full-Time Lecturer to take charge of the Training of Wireless Operators for the Postmaster-General's certificate. The work has been carried on for many years, and includes both full-time day and part-time evening courses.

Salary on the scale £186 12s. to £384, according to experience, subject to deduction of 5% under Teachers' Superannuation Act.

Application should be made, without delay, to the undersigned, giving earliest date at which duties can be entered upon. No form of application is prescribed.

H. E. CURTIS, Secretary.

Offices for Higher Education, The Municipal College, Portsmouth.

**FOREIGN LISTENERS 4 Set of 6 Coils . . . 37/6**  
**SCREENING BOXES . . . 5/- each; . . . 19/- set.**  
**RECORD III Coils 35/- set. KIL0-MAG 4 Coils 33/- set.**  
**1930 EVERY-RAN Coils. 42/6 set. METAL BOXES—**  
**4 Compartments. . . 32/6 Complete Cabinets. . . 45/-**  
**W.W. KIT SET Coils and Switches, mounted . . . 37/6**  
**Metal Boxes . . . 27/6 Complete Cabinets . . . 35/-**  
**S.G. Short Wave 3 Set 4 Coils . . . 20/-**  
**SEND ALL YOUR ENQUIRIES. TRADE SUPPLIED**  
**A. T. STOTT, 1a, Duke St., ROCHDALE.**  
 (Late 63, Syke Road.)

**REPAIRS**  
 Any make of L.F. Transformer, Loudspeaker or headphones repaired and dispatched within **48 HOURS—TWELVE MONTHS' GUARANTEE** with each repair. 4/- Post Free.  
 Terms to Trade.  
**TRANSFORMER REPAIR CO.,**  
 Dept. W.  
 214, High Street, Colliers Wood, London, S.W.19

**EXPERIMENTAL WIRELESS** & The WIRELESS ENGINEER

The Journal for Professional Engineers and Advanced Wireless Experimenters

Monthly 2/6 net.

Annual Subscription 32/- post free.

ILIFFE & SONS LTD., Dorset House, Tudor Street, London, E.C.4.

**PARFAIT THE PERFECT EBONITE**

SUPPLIED IN SIX FINISHES  
 Semi-Polished Black      Semi-Polished Mahogany,  
 Highly Polished Black      Highly Polished Mahogany  
 Matt      Cube Surface

Obtainable from most wireless dealers.

Advertisement of H. B. Potter & Co., Ltd., Station Buildings, ROCHDALE.

**INDEX TO ADVERTISEMENTS.**

Adolph, Fredk. ....	21	Electradix Radios .....	21	Pertrix, Ltd. ....	9
Amplifiers, Ltd. ....	19	Epoch Radio Manf. Co., Ltd. ....	17	Player's .....	9
Applyby, E. Hetherington .....	16	Exact Mfg. Co. ....	20	Portsmouth Municipal College .....	23
Automatic Coil Winder & Electrical Equip- ment Co., Ltd. ....	13	Ferranti, Ltd. ....	7	Potter, H. B., & Co., Ltd. ....	23
B. & J. Wireless Co. ....	16	Garnett, Whiteley & Co., Ltd. ....	10	Premier Supply Stores .....	22
Baker's "Selhurst" Radio .....	18	Glasscoe, R. H., & Co. ....	18 & 20	Radiogramophone Development Co. ....	10
Bayliss, W., Ltd. ....	Cover iii.	Goodmans .....	20	Radio Instruments, Ltd. ....	5
Belling & Lee, Ltd. ....	16 & 18	Grosvenor Battery Co., Ltd. ....	13	Rigby & Woolfenden .....	20
Benjamin Electric, Ltd. ....	2	Holzman, Ltd. ....	8	Rothermel Corpn., Ltd. (Electrad) .....	4
Britannia Rubber & Kamptulicon Co., Ltd. ....	24	Hughes, F. A., & Co., Ltd. ....	Cover i.	Rowley, Thomas A., Ltd. ....	21
British Institute of Eng. Tech. ....	24	Lesingham, F. L. ....	21	Sheffield Magnet Co. ....	11
British Insulated Cables, Ltd. ....	6	Lisemin Wireless Co. ....	24	Squire, Fredk., Ltd. ....	24
Brownie Wireless Co. (G.B.), Ltd. ....	19	Loewin Radio Co., Ltd. ....	Cover iii.	Stott, A. T. ....	23
Bulgin, A. F., & Co. ....	16	London Electric Wire Co. & Smiths, Ltd. ....	3	Telsen Electric Co., Ltd. ....	1 & 22
Burne-Jones & Co., Ltd. ....	23	London Radio Supply Co. ....	20	Thomas, Bertram .....	20
Burton, O. F. & H. ....	7	Lyons, Claude, Ltd. ....	22	Transformer Repair Co. ....	23
Celestion, Ltd. ....	2	Marconiphone Co., Ltd. ....	15	Trelleborg Ebonite Works, Ltd. ....	Cover 2
Cole, H., & Co. (Mer.), Ltd. ....	4	McMichael L., Ltd. ....	Cover ii.	Tulsemore Manf. Co. ....	20
Cole, E. K., Ltd. ....	Cover i.	M-L Magneto Synd., Ltd. ....	8	Ultra Electric, Ltd. ....	19
Cosson, A. O., Ltd. ....	14	Morris, J. E. ....	19	Vandervell, C. A., & Co., Ltd. ....	4
Day, Will, Ltd. ....	8	Mullard Wireless Service Co., Ltd. ....	Cover i.	Watmel Wireless Co., Ltd. ....	12
Donatone .....	8	New London Electron Works, Ltd. ....	12	Westinghouse Brake & Saxby Signal Co., Ltd. ....	12
Dubilier Condenser Co. (1925), Ltd. ....	6 & 11	Ormond Engineering Co., Ltd. ....	Cover iv.	Wingrove & Rogers, Ltd. ....	18
Eastick, J. J., & Sons .....	20	Parker, W. H. ....	20	Wright & Weaire, Ltd. ....	Cover iii.
		Perseus Manf. Co. ....	20		

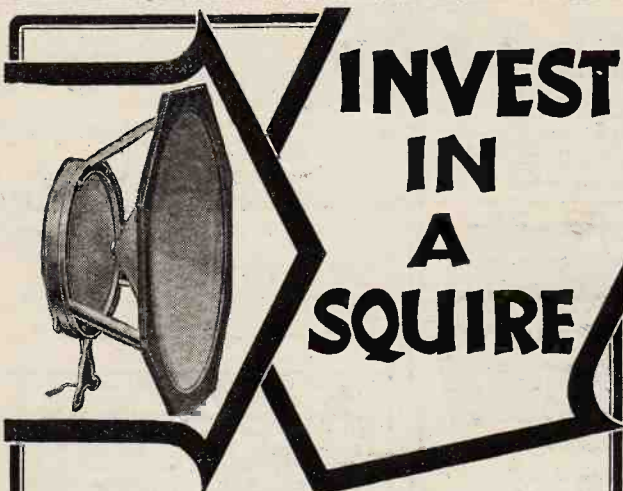

**INVEST  
IN  
A  
SQUIRE**

**S**QUIRE Cone Speakers are a good investment from all points of view. For a very small expenditure they will bring you in reproduction that is only equalled by the most expensive speakers on the market. We make this claim with the utmost confidence, because it has been tested and proved true. There is a Squire Speaker to suit every purse and every requirement. Ask your dealer to demonstrate one and prove our claims for yourself. The 101 is illustrated above.

Retail Prices.  
Price of Cradle complete with cones, octagonal front and enamelled back-stand **2 Gns.** (including Royalty)

Set of four oxy silver chains 3/6; Art silk lamps shade fringe 4/-; Kit for making two cones 7/3.

**Fredk. Squire Ltd.,**  
10, Leswin Place, Stoke Newington, N.16. P. & T.

**ENGINEERS!**  
Can't we get together?



All we ask is the chance to prove that you can earn £300, £400, £500 per year or more. Other men are doing it, and you can do the same

We have an unrivalled and world-wide organisation, waiting to help you whether you be novice or expert. If you wish for something more than a "bread and butter" job you owe it to yourself to investigate our Service.

Our handbook "Engineering Opportunities" has pointed the way to better things to over 20,000 of your fellows. It contains details of A.M.I.Mech.E., A.M.I.E.E., A.M.I.C.E., A.M.I.A.E., A.M.I.Struct.E., London Matric., C & G, G.P.O., etc., Exams., outlines home study courses in all branches of Electrical, Mechanical, Motor and Wireless Engineering, and explains our unique guarantee of

THE FIRST STEP WHICH HAS LED THOUSANDS TO SUCCESS  
*Write for this Book today*  
**IT'S FREE!**

**NO PASS—NO FEE.**

In a Brilliant Foreword Prof. A. M. Low shows clearly the chances you are missing.

"Engineering Opportunities" and our advice are quite FREE. Don't neglect this offer—give vent to that "upward urge" and send a postcard NOW, stating Branch, Post or Exam. which interests you.

**BRITISH INSTITUTE OF ENGINEERING TECHNOLOGY,**  
387, SHAKESPEARE HOUSE, 29-31, OXFORD STREET, W.1.



**LISENIN**  
**POSITIVE GRIP TERMINALS**  
(Patent 245,686)

Maintain their lead established five years since, and are acclaimed by the keen Radio experimenter as the ideal terminal. There is one for all radio connections. Write for descriptive leaflet. It's sent free to all "W.W." readers.

- Plugs and Sockets with 2 nuts..... 4d.
- Spade Ends ..... 3d.
- Standard Wander Plugs..... 2d.
- Chubby Wander Plugs, for portable sets..... 2d.
- Pin Ends ..... 2d.
- All Mains Socket and Plug ..... 6d.

Don't forget Pos. Grips overcome unsightly frayed ends to leads. What a boon!

THE LISENIN WIRELESS COMPANY, SLOUGH, BUCKS.



**BRITKAM**  
SUPER QUALITY  
**EBONITE**  
IN SHEETS, RODS,  
AND TUBES.

PANELS cut to any size and thickness. Matt or polished surface. Guaranteed against surface leakage. Immediate delivery. Prices on application.

Trade enquiries invited.  
**BRITKAM-EBONITE** (Britannia Rubber & Kamptulicon Co. Ltd.)  
7, Newgate Street, London, E.C.1.

# BAYLISS ROTARY CONVERTER

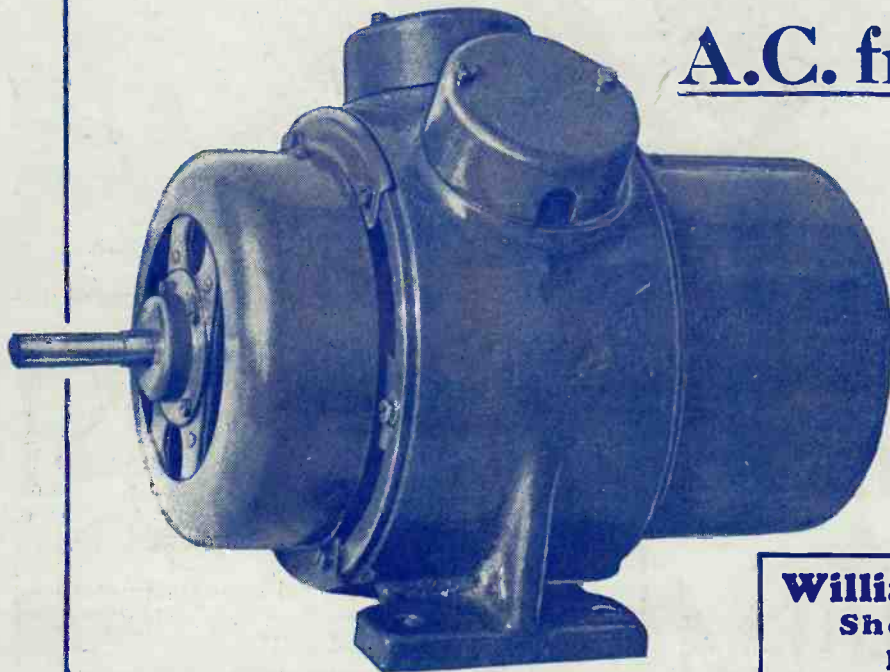

## A.C. from D.C.

Load 400 Watts.

ANY Input.  
ANY Output.

PRICE

**£12. 10. 0**

Delivery  
from Stock.

**William Bayliss Ltd.**  
Sheepcote Street  
**BIRMINGHAM**

Telephone:  
Mid 1409.

Telegrams:  
"Drawbench, B'ham."

# LOEWE RADIO HIGH VACUUM RESISTANCES & CONDENSERS mean BETTER SETS and BIGGER SALES!

Full particulars  
and Trade  
Terms from

The LOEWE  
Radio Co. Ltd.  
4, Fountayne  
Rd. Totten-  
ham, N.15.

Phone:  
Tottenham.  
3911/2.



No manufacturer can afford to overlook the unquestionable efficiency of LOEWE RADIO Resistances and Condensers. Those tried and tested components make set efficiency an unequalled success and with better sets, better sales must follow. Set manufacturers should compare these LOEWE RADIO Resistances with those that they may be using. In the meantime consider LOEWE RADIO RESISTANCES never vary and "crackling" is effectively eliminated. They are moisture and dust-proof and carry up to 10 watt without appreciable heating or change of resistance value. LOEWE RADIO CONDENSERS have their condenser element enclosed in a high vacuum internal insulation and this eliminated defective and supplied with wire ends for wire soldering.

# WEARITE COMPONENTS

### 1930 EVERYMAN FOUR.

Coils per set £2 - 7 - 6

### NEW KILOMAG FOUR.

Coils per set £2 - 5 - 0

### WIRELESS WORLD KIT SET.

Coils per set £2 - 5 - 6

### DECOUPLING RESISTANCES.

500 or 600 ohms .. 1s. 6d.

Fixed resistances wire wound

1,000-5,000 10,000 15,000 20,000 25,000 ohms  
2/- 2/6 3/- 3/3 4/- each

### FOREIGN LISTENERS FOUR.

B.B.C. Coils, per set of 3 £1 - 2 - 6

5XX Coils, per set of 3 £1 - 17 - 6

Coil Bases, per set of 3 £0 - 7 - 6

Write for illustrated lists:

**WRIGHT & WEAIRE, LTD.**  
740, HIGH ROAD, TOTTENHAM, N.17.

Telephone: Tottenham 3847/8. 137

# TO HEAR IT IS TO BELIEVE IT!

**20/-**  
PRICE  
COMPLETE

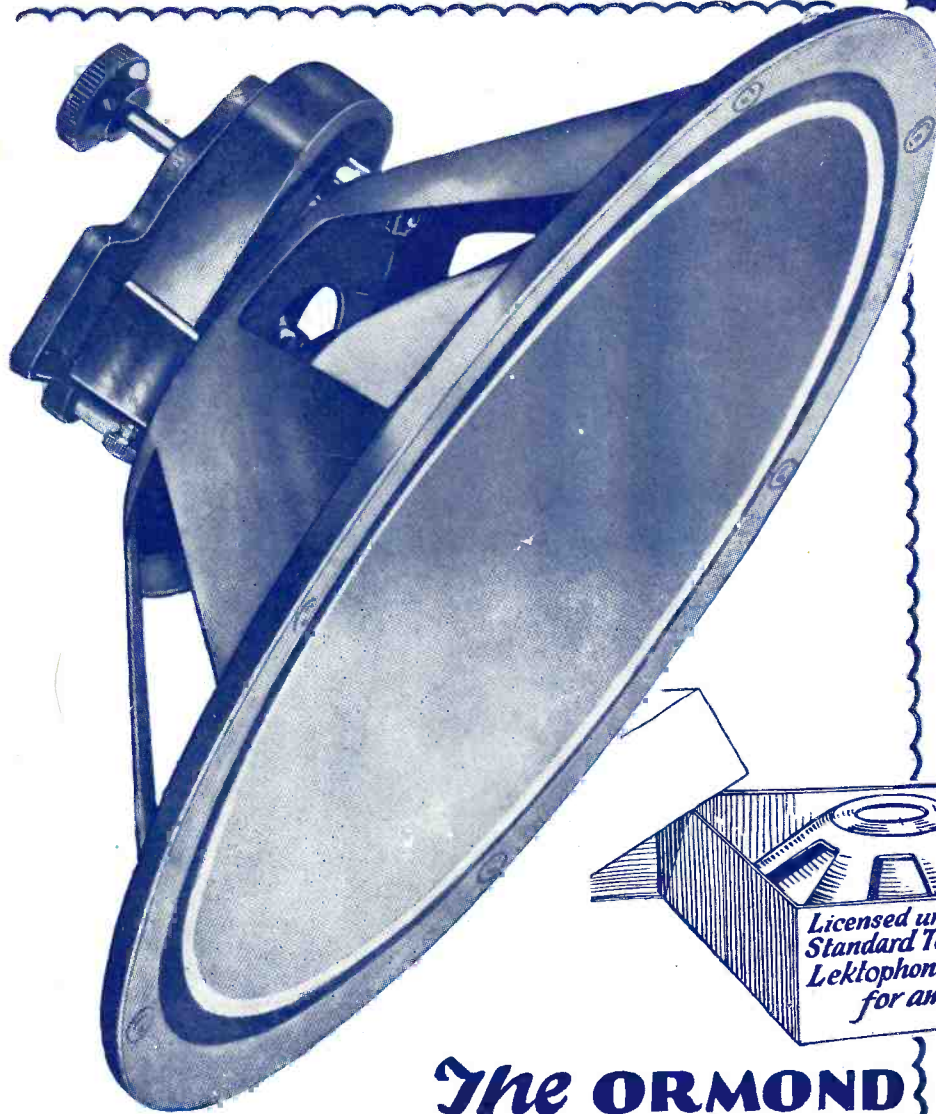

RADIO WEEK,  
JAN. 12 to 18.

Hear the special B.B.C. Programmes reproduced with that perfect veracity obtainable only with the great Ormond combination—the Ormond Cone Unit and Chassis. Like all Ormond products this new Ormond Cone Speaker is convincing in its superiority. Tone, volume, sensitivity—every factor of perfect reproduction denotes ideal design and construction. Comprising the famous Ormond 4-Pole adjustable Loud-speaker Unit, the wonder cone and especially strengthened aluminium chassis. Wonderful value giving wonderful results. Supplied unassembled and securely packed in carton for 20/- complete.

*for PUNCH  
POWER &  
PURITY!*



*Licensed under the Patents of the  
Standard Telephones & Cables Ltd. &  
Lektophone & Hopkins Corporations  
for amateur use only*

## The ORMOND } CONE=UNIT & CHASSIS

Also supplied separately. Chassis and Cone 7/6. Unit 12/6.  
THE ORMOND ENGINEERING CO. LIMITED,  
ORMOND HOUSE, Rosebery Avenue, LONDON, E.C.1.  
Phone: Clerkenwell 5334-5-6 and 9344 5-6. Telegrams: "Ormondengi, Smith."



Printed for the Publishers, LITTLE & SONS LTD., Dorset House, Tudor Street, London, E.C.4, by The Cornwall Press Ltd., Paris Garden, Stamford Street, London, S.E.1.

Colonial and Foreign Agents:  
UNITED STATES—The International News Co., 131, Varick Street, New York. FRANCE—W. H. Smith & Son, 248, Rue Rivoli, Paris; Hachette et Cie, Rue Réaumur, Paris.  
BELGIUM—W. H. Smith & Son, 78, Marche aux Herbes, Brussels. INDIA—A. H. Wheeler & Co., Bombay, Allahabad and Calcutta. SOUTH AFRICA—Central News Agency Ltd.  
AUSTRALIA—Gordon & Gotch, Ltd., Melbourne (Victoria), Sydney (N.S.W.), Brisbane (Queensland), Adelaide (S.A.), Perth (W.A.), and Launceston (Tasmania).  
CANADA—The American News Co., Ltd., Toronto, Winnipeg, Vancouver, Montreal, Ottawa, St. John, Halifax, Hamilton; Gordon & Gotch, Ltd., Toronto; Imperial News Co. Toronto, Montreal, Winnipeg, Vancouver, Victoria. NEW ZEALAND—Gordon & Gotch, Ltd., Wellington, Auckland, Christchurch and Dunedin.

Sorry another mistake. I turned over 2 pages  
together. Pages 70 + 71 are in wrong place  
and moving 2 places back to get in right order.

Dave

4<sup>D</sup>

# The Wireless World

## AND RADIO REVIEW

### The Paper for Every Wireless Amateur

Wednesday, January 22nd, 1930.

## BurTON SELF-LOCATING VALVE HOLDER



**1/- each**

Pentode - Valve - Holders 1/6 each

Patent No. 316708

MANUFACTURED BY C. F. & H. BurTON  
PROGRESS WORKS WALSALL, ENG.



**TELSEN**  
L.F. TRANSFORMERS  
*Radio's Choice*

Have acquired a world-wide reputation for Quality and Value.

Built by Specialists in Transformer construction, they have set a Quality of Performance above reproach. Your Set will work better with a Telsen Transformer - - - Fit one now!

**RADIOGRAND 12/6**

**TELSEN ELECTRIC CO. LTD.,**  
Miller Street, Birmingham.

## HEAR THIS GREAT SPEAKER ACHIEVEMENT



The **ULTRA POPULAR "FIFTY"** embodies the famous Double Linen Diaphragm. Possesses all the acoustic advantages of small diaphragm for high, and large diaphragm for low audible frequencies. Even frequency response. Scientifically balanced for area, mutual tension and juxtaposition. In solid oak or mahogany. From all radio dealers and music shops.

**50/-** **ULTRA**  
**AIR CHROME SPEAKER**  
**WITH THE DOUBLE LINEN DIAPHRAGM**

ULTRA ELECTRIC LTD., 661, HARROW ROAD, LONDON, N.W.10

## McMICHAEL PORTABLE RECEIVER 22 GNS.

Point No. 1.  
**SELECTIVITY.**  
At the gates of Brookmans Park (both wavelengths being radiated) both programmes and Continental stations were received with complete separation.

Hear it at any high-class radio store or our London showrooms.  
**L. McMICHAEL LTD.,**  
Wexham Road, Slough, Bucks.  
179, Strand, London, W.C.2.





EVER  
RE



EVER READY  
WIRELESS DRY BATTERIES  
ARE TROUBLE-FREE AND  
ENSURE THE PUREST  
AMPLIFICATION

**Special EVER READY units  
for Portable Sets**

Careful attention has been given to modern practice in portable set construction, and the following three batteries are specially designed for use with them. These units should cover the range of replacements required for most standard models.

- 63 PORTABLE ONE VOLTS, 6" x 5" x 3" 8/6
- 99 PORTABLE TWO VOLTS, 9" x 5" x 3" 13/6
- 108 PORTABLE THREE VOLTS, 10" x 5" x 3" 15/-

**THE BATTERY FOR YOUR PORTABLE SET**

*—with a great name behind it!*

*Mention of "The Wireless World," when writing to advertisers, will ensure prompt attention.*

# FERRANTI RADIO

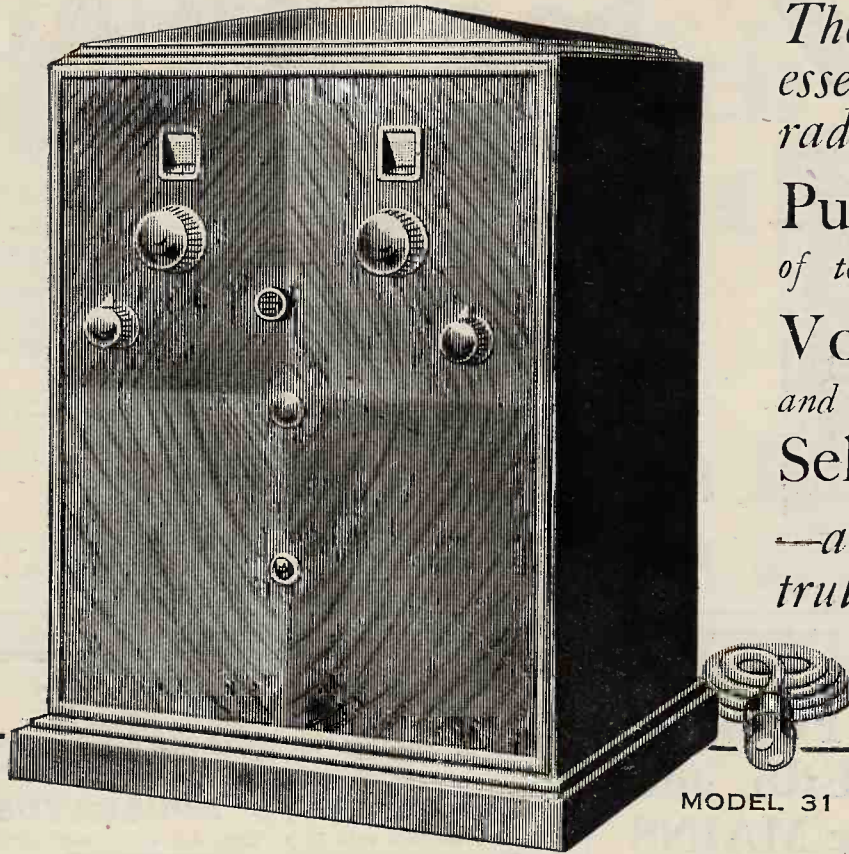

MODEL 31

*The three  
essentials of  
radio reception—*

**Purity**  
*of tone;*

**Volume,**  
*and*

**Selectivity**

*—are well and ★  
truly balanced.*

**T**HE FERRANTI "All Electric" Radio Receiver is designed by experts in the art, and built on sound engineering principles.

★ Whilst we make no extravagant claims we can definitely declare that our Set has been scientifically measured and compared with many others, and found equal to any and better than most in all the three essentials.

*A special order from your dealer  
will ensure prompt delivery.*

Write for illustrated book, and, if you are interested, we will arrange for a demonstration in your home.

The price, including valves, is £25 in Oak Cabinet, and £26 in Walnut or Mahogany Cabinet. Royalty £1 extra. This set is available for Alternating Current mains only, voltages 200/250, 40 cycles or over.

**FERRANTI LTD.**  
**HOLLINWOOD**  
**LANCASHIRE**

# Let your 1930 battery

# be a Tudor

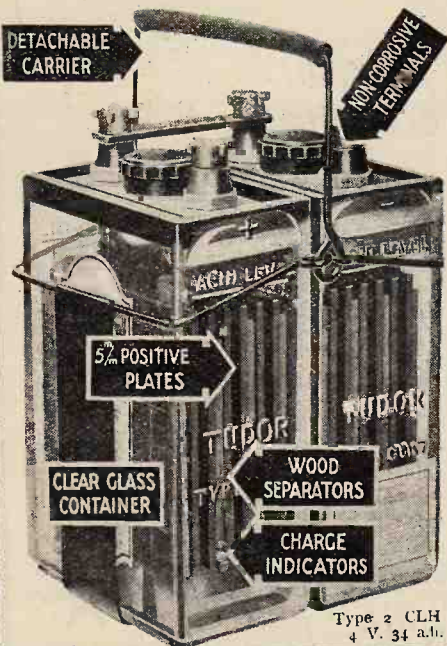

Type 2 CLH 7  
4 V. 34 a.h.

In the field of good batteries Tudor, with its long life and reliability, always leads the way. The Tudor Monolt Unit is the ideal accumulator for your set. Every part has been carefully designed, and is the result of thirty years battery experience. With this accumulator you will obtain a definite refinement in reception, combined with a much longer life. Among its many characteristics are the charge indicators, which show you when the cells are running down. It has all the usual Tudor features, including non-corrosive terminals and 5 m/m positive plates. Despite these advantages, Tudor costs little more than ordinary accumulators, and in comparison with the excellent results obtained the slight extra cost is well worth while.

ESTABLISHED IN PUBLIC SERVICE.

# 27!

Complete

**COUPON**

Please send me full particulars of Tudor Wireless Batteries.

Name.....

Address.....

Tudor Accumulator Co., Ltd., 2, Norfolk St., Strand, London, W.C.2.

M.C. 47.

## Superior A.C. POWER TRANSFORMERS and CHOKES for the MAINS

from  
**35/-**  
for all  
Inputs  
and  
Outputs

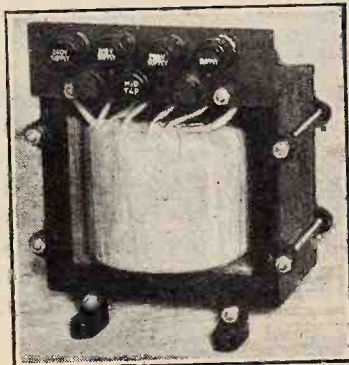

Special Audio-Frequency Chokes and Transformers, and Smoothing Chokes for all purposes.

**WILLIAM BAYLISS LTD.,** Shepcote Street,

Telephone:  
Mid. 1439.

Telegrams:  
"Drawbench, B'ham."

**BIRMINGHAM.**

# EDDYSTONE

## SCIENTIFIC SHORT WAVE APPARATUS

A complete inductance outfit for a short wave detector receiver which can be followed by L.F. stages. Comprising variable aperiodic aerial coil, grid coil, Reinartz reaction coil and mounting stand. Highly efficient. Full instructions and diagram with every outfit. Interchangeable B.B.C. coils obtainable. 5 coils and stand.

TYPE A.V. UNIT. 18-90 METRES.



PRICE  
**20/-**  
Complete.

## SCIENTIFIC H.F. CHOKE

2,000 to 12 METRES.

A redesigned model with an effective range of 2,000 to 12 metres. Specially suitable for screened grid H.F. circuit where the choke is of vital importance, and in all other positions. Used solely in "EDDYSTONE" short wave receivers. Takes up very little room and has an exceptionally small outside field.

PRICE **6/6**

SEND FOR LISTS OF S.W. APPARATUS.

Sole Manufacturers:  
**STRATTON & CO. LTD.,**  
BROMSGROVE STREET,  
BIRMINGHAM.



London Service Depot:  
**WEBB'S RADIO ELECTRIC STORES,**  
164, Charing Cross Road,  
W.C.2.

Tel.: Gerrard 1544.

Mention of "The Wireless World," when writing to advertisers, will ensure prompt attention.

A2

EVERYTHING



ELECTRICAL

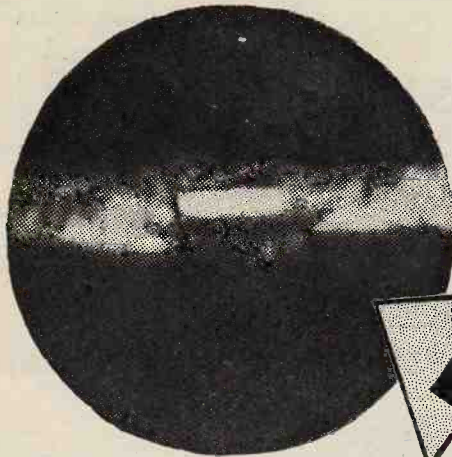

Which would  
you choose-

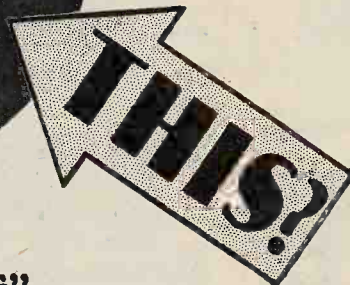

or

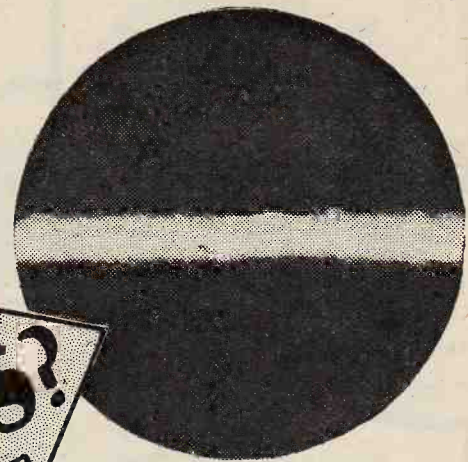

**A BAD Filament  
WITHOUT  
"TENACIOUS COATING"**

Reproduction from an untouched microphotograph showing part of the filament of a badly coated valve before use, showing a serious gap in the coating. A gap such as this starts the valve off in its life with a poor performance. The valve then prematurely fails.

**A GOOD Filament  
WITH  
"TENACIOUS COATING"**

This reproduction shows the coating typical of all OSRAM VALVES. Notice the absolute evenness of the coating. There are no gaps, the coating clings, so that the full benefit of the coating is maintained. The secret is the startling discovery of the scientific process of "TENACIOUS COATING."

SOLD BY ALL WIRELESS DEALERS

**Osram  
Valves**  
with the  
**"TENACIOUS COATING"**

**WRITE** for booklet "OSRAM WIRELESS GUIDE" giving full particulars of the full range of OSRAM VALVES with the "TENACIOUS COATING." Also helpful wireless information of importance to every listener. Sent post free.

MADE IN ENGLAND

Advt. of The General Electric Co., Ltd., Magnet House, Kingsway, London, W.C.2.

A3 Advertisements for "The Wireless World" are only accepted from firms we believe to be thoroughly reliable.

# DUBILIER FOR STAUNCH RESISTANCES

## DUMETOHMS



.25, .5, 1, 1.5, 2, 3, 4, 5 and 10 Megohms. Other Higher Values specially to order. Each **2/6**

## RESISTORS



Any standard value. Each **1/-** Holder (Horizontal or Vertical). Each **1/-**

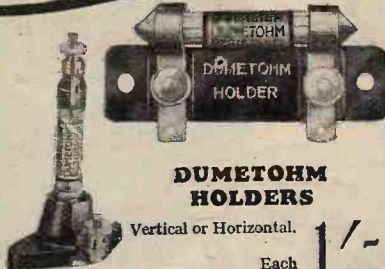

## DUMETOHM HOLDERS

Vertical or Horizontal. Each **1/-**

## DUWIROHMS



(Horizontal Type)  
10,000 to 100,000 ohms **5/-**  
150,000 and 200,000 ohms **8/-**  
250,000 ohms **9/9**  
300,000 ohms **11/6**  
Holder for horizontal type **1/6**

**FREE**  
for the asking—  
the Dubilier Book—  
let entitled "A Bit  
about a Battery."  
Get a copy from  
your dealer.

# DUBILIER RESISTANCES

If you have any difficulty in obtaining Dubilier Products, please write direct, giving your Dealer's name and address, to  
**DUBILIER CONDENSER CO. (1925) LTD.,**  
Ducon Works, Victoria Rd., N. Acton, London, W.3

Cleaver

BC278/R

Mention of "The Wireless World," when writing to advertisers, will ensure prompt attention.

# Did You Listen ? RADIO WEEK

and were  
**YOU**  
**SATISFIED?**  
**IF NOT:—**

**YOU** or **YOUR**  
friends may desire  
"something Better  
in Radio"—we  
believe we can  
Interest you.

Get the Experts to  
Advise You :—  
The **R.G.D. Radiogramophone**



For the highest possible quality and tone for both radio and record, with ample volume, incorporating the latest developments in moving coil speaker; operates entirely from electric mains, A.C. any voltage, or D.C. 200 volts or over.

Mahogany  
**£80**

Oak  
**£75**

A Pick-Up  
of  
Distinction.

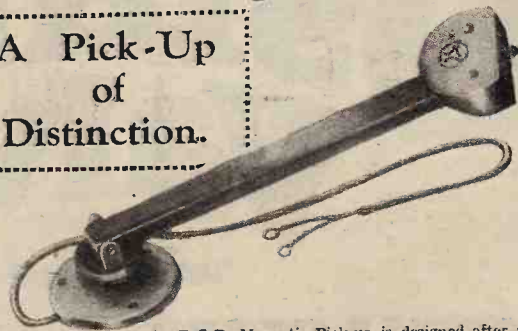

The R.G.D. Magnetic Pick-up is designed after years of experiments, and we believe it to be as perfect as possible. No record wear, perfect tracking, a scientific instrument, specially developed for moving coil speaker reproduction. Price **£3** in bronze, **£3-3-0** in oxidised silver.

Place your order now to ensure delivery and we shall be pleased to supply literature on application.

**The Radiogramophone Development Co.,**  
St. Peter's Place, Broad Street, Birmingham.

AA



# -and no crackle

Every sal-ammoniac battery begins to "crackle" far too soon. "Pertrix" simply cannot "crackle," for its electrolyte produces no corrosion. Nor can "Pertrix" lose power when not in use. These two points alone place "Pertrix" in a peerless position.

Use no battery but that with "pep."

## PERTRIX SUPER LIFE H.T. BATTERIES

PERTRIX LIMITED, Britannia House,  
Shaftesbury Avenue, London, W.C.2.  
Factory: Britannia Works, Redditch, Worcs.

### LONGER LIFE!

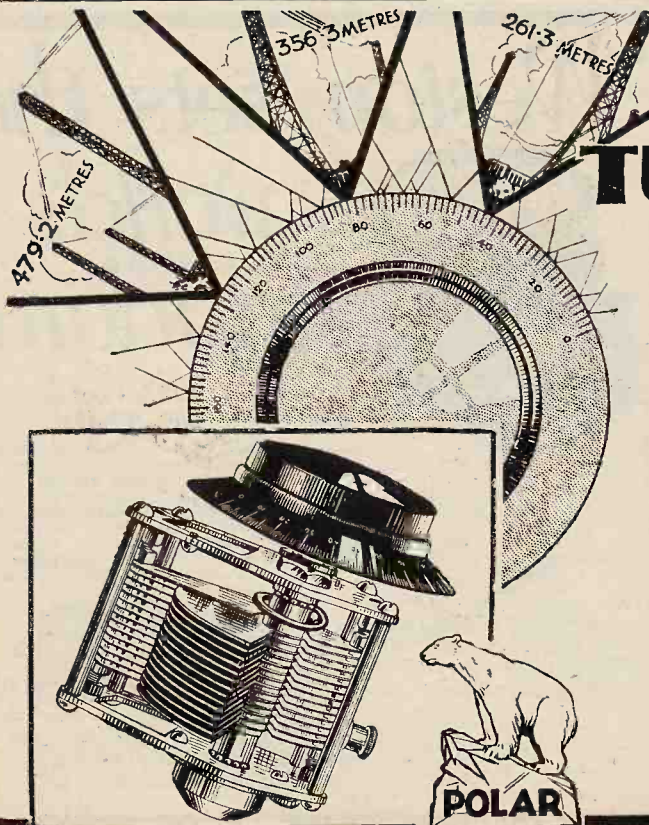

# WIDE TUNING RANGE

Because Polar Condensers are scientifically designed—have accurately spaced vanes and low minimum self capacity—they give you a definitely wider range of tuning.

There is no need to sacrifice listening to 5 GB (479 metres) because you want Brookman's Park (261 metres) transmission. The Polar "Ideal" or Polar "No. 3" Condenser of .0005 capacity will tune them all in on any standard circuit receiver.

Polar Condensers give velvet-smooth control, and the "Ideal" with both Fast and Slow motion gives knife-edge selectivity. Both the Polar "Ideal" and "No. 3" will make a wonderful difference to your range of reception.

POLAR "IDEAL" .0005 12/6. POLAR "No. 3" .0005 5/9.  
.0003 12/-. .0003 5/6.

## POLAR CONDENSERS

Obtainable from all Dealers. Write for Free copy of  
"Polar" Catalogue (W).

WINGROVE & ROGERS, LTD.,  
188-9, STRAND, LONDON, W.C.2.  
Polar Works: Mill Lane, Old Swan, Liverpool.

# The **REGENTONE** "Portable" H.T. Mains Unit

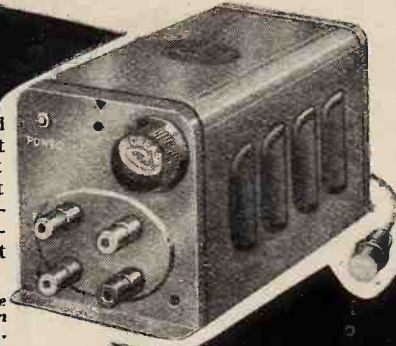

This new Regentone Model is specially designed for Portables. Three separate positive output sockets—one variable—on a separate circuit principle are provided to ensure those exact critical values of voltage so necessary in Portables for maximum efficiency. Special precautions have been taken entirely to prevent the possibility of any external field.

The Regentone 12 months' **GUARANTEE** covers the Westinghouse Metal Rectifier incorporated in this and in all Regentone A.C. Mains Units and Mains Receivers.

For A.C. or D.C. Mains.

A.C. Model **£4 5 0**  
D.C. Model **£2 15 0**

Write to-day for **FREE ART BOOKLET** "Radio from the Mains" and for particulars of Regentone **HIRE PURCHASE TERMS**.

**fits inside every**

**Portable standard**



**REGENT RADIO SUPPLY CO., 21, Bartlett's Bldgs., Holborn Circus, London, E.C.4. Telephone CENTRAL 966.**

## THE FINEST VERNIER DIAL OBTAINABLE

MECHANICALLY PERFECT, POSITIVE BRASS CONTACT drive on **SOLID BRASS SCALE** ensuring smooth movement, with absolutely **NO BACK-LASH**. **ROBUST** in Construction and Trouble Free. **SMALL, EXTREMELY ELEGANT, EFFICIENT.**

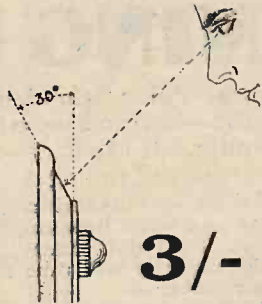

**3/-**

**TUNING WITHOUT IRRITATING UNCOMFORTABLE CROUCH OR STOOP.**

As pictorially shown, the scale and aperture are inclined at an angle of 30° from perpendicular, thereby permitting convenient unobstructed view of scale without need to crouch or stoop.

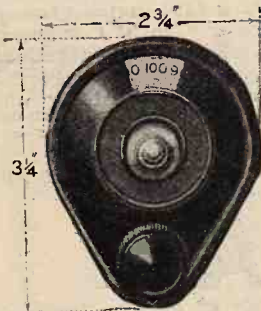

If unable to obtain from dealer please communicate with us. Full Catalogue sent post free on receipt of post card.

**THE FORMO CO., CROWN WORKS, CRICKLEWOOD LANE, LONDON, N.W.2**

## Weston sets the world's standard



Model 528, Pocket Size A.C. Tester

A small and reliable instrument essential to maintain accuracy and efficiency in Voltage control. The sensitivity is remarkably high, 6 m.a. for 600 volts with self-contained resistance. The Scale is very legible and the damping excellent. This instrument is capable of continuous service at full load.

Prices from

**£3. 10. 0 to £4. 15. 0**

**WESTON ELECTRICAL INSTRUMENT CO., LTD.**

15, Great Saffron Hill, London, E.C.1

Write for your copy of "Radio Control," which explains simply the electrical operation of a radio set. Sent free on receipt of a postcard addressed to:—



## FOR ELIMINATOR CIRCUITS

You cannot afford to use any but the best Condenser in an eliminator circuit.

### HELSEBY CONDENSERS

are made and guaranteed by a firm with 30 years' experience in condenser making, from small telephone and radio condensers to Power Condensers weighing upwards of 2 tons.

Guaranteed working voltages :-

Type M	-	-	150 volts D.C.
Type 2A	-	-	350 volts D.C.
Type 3A	-	-	450 volts D.C.
Type 4A	-	-	600 volts D.C.

All Helsby Condensers are vacuum dried and impregnated with a special non-hygroscopic material which renders them moisture proof.

If unobtainable from your dealer, write to us giving his name and address.



## BRITISH INSULATED CABLES LTD

PRESCOT - LANCS.

Makers of PRESCOT and HELSEBY cables

# GET THEM BOTH TOGETHER . .

## 66 K UNIT 25/-

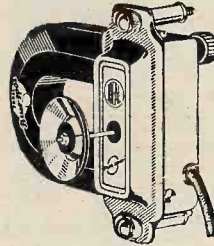

When getting your 66K Unit, ask your wireless dealer to demonstrate the Blue Spot Chassis.

You will then hear what the 66K Unit really can do—for it is working under ideal conditions, driving a chassis specially made for it.

The Blue Spot Chassis is made in two sizes, complete with cone:

The Major (13" cone) 15/-

The Minor (9 1/4" cone) 12/6

Both Blue Spot and both the finest value obtainable.

# BLUE SPOT CHASSIS

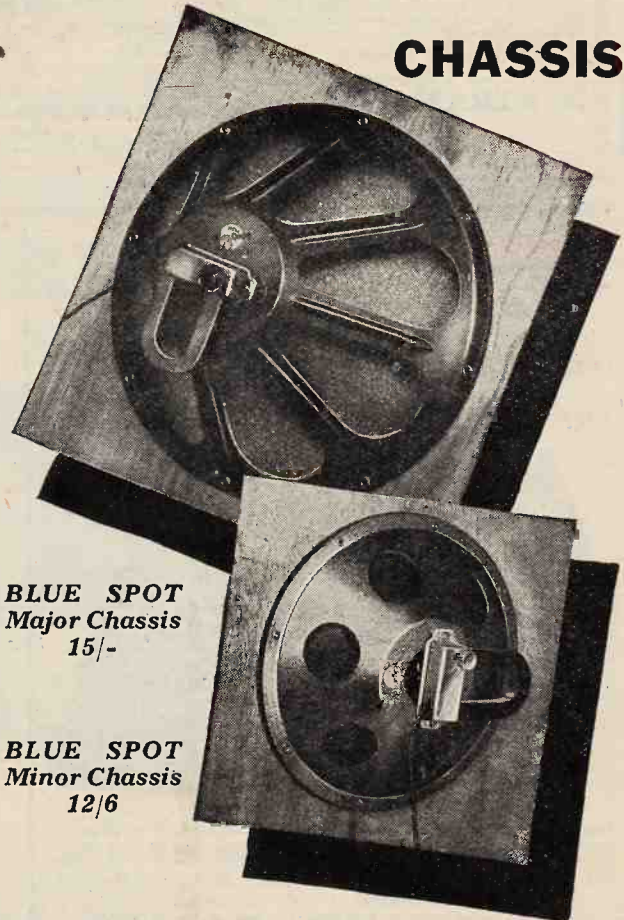

**BLUE SPOT Major Chassis**  
15/-

**BLUE SPOT Minor Chassis**  
12/6

## F. A. HUGHES & CO., LIMITED

204-6 Gt. Portland St., London, W.1. 'Phone: Museum 8630 (4 lines).

Distributors for Northern England, Scotland and North Wales,

H. C. RAWSON (SHEFFIELD & LONDON) LTD.,

100 London Rd., Sheffield. 'Phone: Sheffield 26006. 22 St. Mary's Parsonage, Manchester. 'Phone: Manchester City 3329.



**The World of Wireless needs these helps!**

THEY SAVE  
ENDLESS WORRY,  
WASTED TIME,  
AND MONEY.

**THE "BENCHRACK."**  
(Tiltrack Principle.)

No builder of Wireless Sets, no Factor or Retailer should be without this splendid help. It stands on the workbench and enables all small parts such as Terminals, Nuts, Bolts, Washers, Condensers, etc., to be stored right to hand. All parts needed for the job in progress are thus on the spot. It is a tremendous time-saver. All the trays are tilted so that the parts stored can be seen at a glance; and, furthermore, to facilitate rapid removal of the goods the front faces of the trays are rounded. Each tray is provided with patent hinging partitions which can be rapidly moved to make larger or smaller compartments. They are all steel and a really sound job. They are stronger, neater, cleaner, and much more efficient in every way than wooden shelves, and they cannot catch fire. Being so accessible they save tremendous time when stocktaking. The Experimenter will do his jobs much quicker and with greater pleasure; and the Factory, Factor, and Retailer will save many pounds per year by installing this Benchrack.

Price **30/-** Carr. extra.

Particulars from Manufacturer & Patentee—  
**BERTRAM THOMAS,**

**Worsley Street, Hulme,  
MANCHESTER.**

London Office and Showroom:—28, Victoria Street, S.W.1.

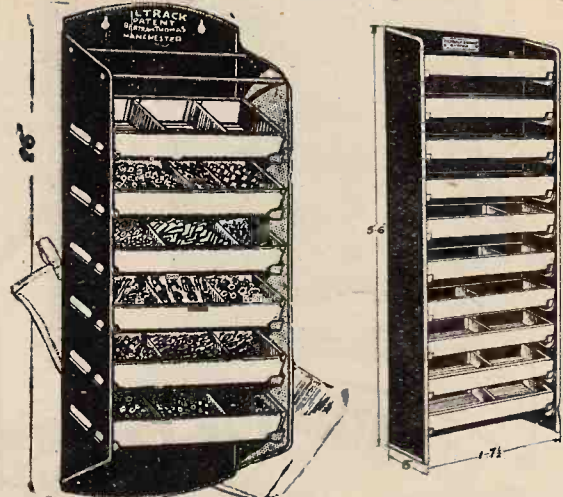
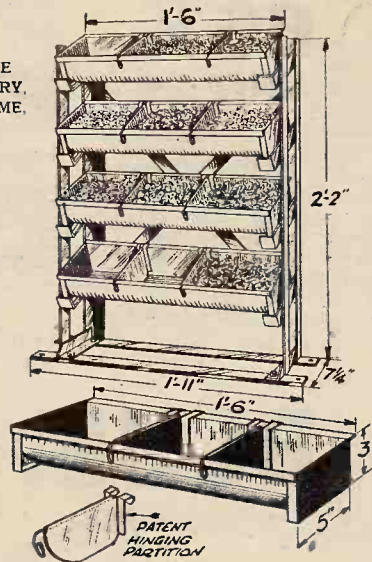

**"TILTRACK" JUNIOR** **30/-**  
Post Free.

**"TILTRACK" TWEENIE** **70/-**  
Post Free.

A splendid rack for storing small components. Made of steel and supplied with canvas protective cover. A most popular rack that very quickly pays for itself.

A most useful rack somewhat bigger than the "Junior." Very compact with great storage capacity. Compartments sub-divisible at will.

The  
**Dixonometer**  
indicates the pinnacle of utility  
for electrical measurements.

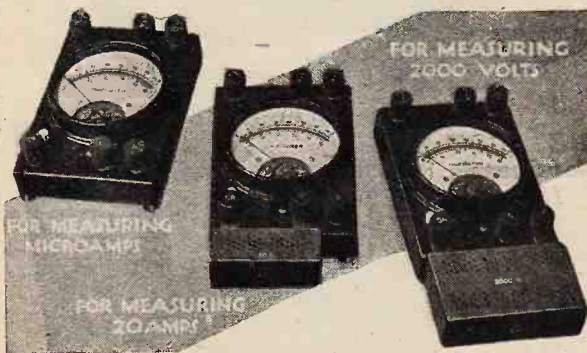

50 ranges on one meter.  
The Rolls-Royce of Radio Testers. Highest Grade at a low price.  
**METER ONLY 50/- RADIO SET £4 10s.**  
Half the price of old-fashioned designs. Order one for 1930.  
SAVES RADIO USERS POUNDS.

**ELECTRADIX RADIOS,**  
218, Upper Thames Street, London, E.C.4.  
Blackfriars Station, Underground Railway. Phone: City 0191.

# HYDRA



**THE OUTSTANDING  
FEATURE OF A  
GOOD MAINS UNIT!**

Look at any good mains unit! See how often Hydra Condensers are incorporated! The best manufacturers and the wisest amateur constructors know that Hydra Condensers provide the greatest margin of safety—because Hydra are built to stand up to overloads and have never been known to break down under normal conditions.

**LOUIS HOLZMAN**  
37, Newman Street,  
London, W.1.

Telephone:  
Museum 2641.

Mention of "The Wireless World," when writing to advertisers, will ensure prompt attention.

# Radio's Supreme Power



**ARE YOU PROUD  
OF YOUR NEW SET?  
DO IT JUSTICE  
AND FIT THE BEST  
POSSIBLE BATTERY**

Grosvenor Batteries give continuous and satisfactory service because they incorporate a new vitalising element which is unique to Grosvenor.



66 v. from 7/6      Super Capacity for Multi-Valve Sets      { 66 v. 20/-  
99 v. „ 11/6      { 99 v. 32/6

## The Grosvenor Battery

BRITISH MANUFACTURE

GROSVENOR BATTERY CO., LTD., 2-3, White St., MOORGATE, LONDON, E.C.2. Phone: Met. 6865

# ALL ELECTRIC - 2

A SET WORTH LISTENING TO

£13



£13

The Igranic All Mains 2 operates entirely from A.C. Mains. Compact design. One knob control. Dual wave switch to eliminate coil changing. Perfect reproduction.



Supplied in attractively designed oak or mahogany table cabinet. Price £13.0.0 complete with valves and royalties.

Please state exact mains voltage when ordering. Write to Dept. U 305 for details.

**T.C.C.**  
acquire Sole  
Selling Rights  
in



**T**HE Telegraph Condenser Co., Ltd.—  
the Makers of the world-famous T.C.C.  
Condensers—have pleasure in announc-  
ing that they have acquired sole selling  
rights in "Microfu," product of Micro-  
fuses, Ltd.

The "Microfu" is made in various ratings,  
from 5 milliamperes to 1000 milliamperes,  
and is suitable for the protection of valves,  
wireless sets, eliminators and all instru-  
ments taking small currents. It remains  
constant and will carry a load within 80%  
of its blowing point. It blows to within 10%  
of its rated value and operates with the  
extreme rapidity of 1/1000 second.

The "Microfu" will now have behind it  
the backing of the whole T.C.C. organiza-  
tion, with its unrivalled and world-wide re-  
putation.

Cartridge : 2/-.  
Complete with Holder : 2/9.  
The "Microfu" is made in a wide  
range of types to blow at from 5  
m/a to 1000 m/a. Obtainable  
from all dealers.



**POLICY**

The T.C.C. will continue as here-  
tofore their policy of manufactur-  
ing Condensers only.

**TELEGRAPH CONDENSER  
Co., Ltd., Wales Farm Road,  
NORTH ACTON, W.3.**

CA 3229

Mention of "The Wireless World," when writing to advertisers, will ensure prompt attention.

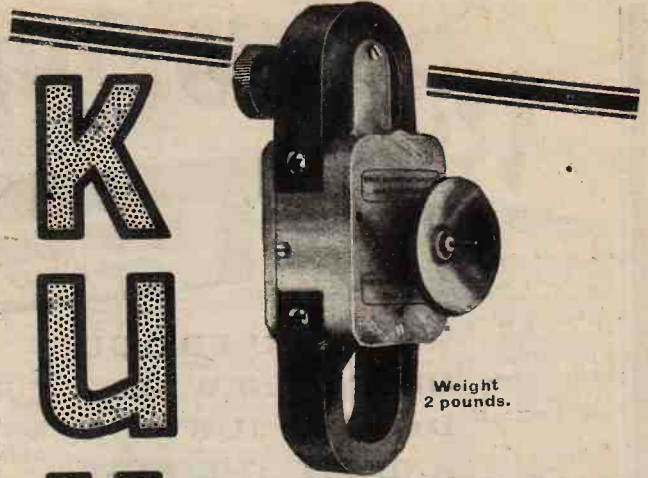

Weight  
2 pounds.

**The SUPER  
SPEAKER  
UNIT**

The unit that realises the possibilities  
of your set. You do not know what your  
set is capable of until you have heard  
the "Kukoo."  
Without fear or favour we claim the  
"Kukoo" unit to give results equal to  
Moving Coil. Radio Experts and Music  
Critics are agreed that for faithful repro-  
duction over all transmitted frequencies  
it leads the field.

**Do Not Believe  
Our Claims only—  
READ THIS PROOF!**

**K  
U  
K  
O  
O**

**TOM PRENDERGAST**  
24, UPPER BROOK ST., CUMM. MANCHESTER  
PROFESSIONAL ENGINEER, SPECIALIST IN ELECTRIC, MECHANICAL, AND AERONAUTICAL ENGINEERING

7/12/29  
Gents. I have fitted the  
"Kukoo" L.S. (Baffle-board 36")  
& have obtained absolutely  
Moving Coil results. Wonderful.  
Thanks. Yours etc.  
Prendergast

Sole Patentees & Manufacturers :—  
THE  
SHEFFIELD MAGNET CO.  
BROAD LANE, SHEFFIELD.

Phone :—20866.  
Grams :—Magnet 20866 Sheffield.

Specially  
designed  
Kukoo  
Chassis and  
10 1/2" Cone,  
15/6  
post free.



Postage 9d. extra.

# CURRENT FOR YOUR MOVING COIL SPEAKER.

THE COMPARATIVELY HEAVY SUPPLY DEMANDED BY THE POT MAGNETS CAN BE VERY EASILY OBTAINED FROM YOUR A.C. HOUSE MAINS WITH THE AID OF

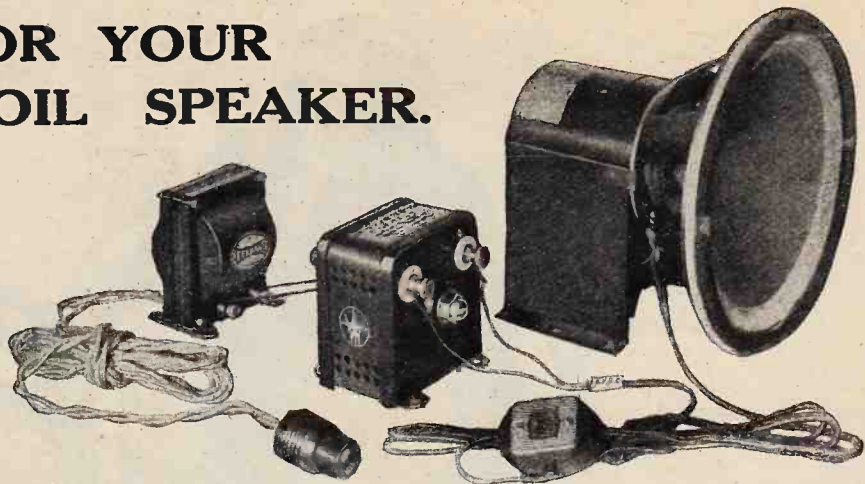

A



## METAL RECTIFIER.

Full particulars, and circuits, showing how to use all types of Westinghouse Metal Rectifiers, are given in our 32-page book "The All-Metal Way, 1930." It includes a chapter of useful information on the running of moving coil speakers from the mains.

Send 2d. stamp for a copy.

The Westinghouse Brake & Saxby Signal Co. Ltd.,  
82, York Road, King's Cross, London, N.1.

## IF YOUR SUPPLY MAINS ARE D.C.

You can use an A.C. All Electric Receiver  
By Employing The M.L.—D.C. to A.C.



## ROTARY TRANSFORMER

Recommended and used by

Philips Radio,  
Marconiphone,  
Burndept,  
Kolster-Brandes,  
M.P.A., Etc., Etc.

Can be supplied to run from any Voltage 12-250 V. D. C.

40 WATT Model  
£13-0-0

85 WATT Model  
£19-0-0

M-L MAGNETO SYND. Ltd., Radio Dept., COVENTRY.  
Telephone: 5001.



WHEN you buy a Screened Grid Valve insist on the one which will give you the longest service—the **NEW** Cossor. The Interlocked Construction system, used exclusively in the **NEW** Cossor Screened Grid Valve has proved itself, *in actual service*, to be the most reliable, the most robust and the most dependable method of valve construction yet devised. For power, for reliability and for long life, use the **NEW** Cossor Screened Grid Valve in your Receiver. Every Dealer sells it.

The **NEW** Cossor 220 S.C.  
(2 volts 2 amp.) Impedance  
200,000. Amplification  
Factor 200.  
Anode Volts  
120-150. Price **22/6**

Cossor 4 and 6 volt  
Screened Grid Valves are  
also obtainable from all  
Wireless Dealers.

# The **NEW** **COSSOR** Screened Grid Valve

A. C. Cossor Ltd., Highbury Grove, London, N.5

 8207

Mention of "The Wireless World," when writing to advertisers, will ensure prompt attention.

A12

# The Wireless World

AND  
RADIO REVIEW  
(17<sup>th</sup> Year of Publication)

No. 543.

WEDNESDAY, JANUARY 22ND, 1930.

VOL. XXVI. No. 4.

Editor: HUGH S. POCKOCK.

Assistant Editor: F. H. HAYNES.

Editorial Offices: 116-117, FLEET STREET, LONDON, E.C.4

Editorial Telephone: City 9472 (5 lines).

Advertising and Publishing Offices:

DORSET HOUSE, TUDOR STREET, LONDON, E.C.4.

Telephone: City 2847 (13 lines). Telegrams: "Ethaworld, Fleet, London."

COVENTRY: Hertford Street.

Telegrams: "Cyclist, Coventry." Telephone: 5210 Coventry.

BIRMINGHAM: Guildhall Buildings, Navigation Street.

Telegrams: "Autopress, Birmingham." Telephone: 2970 and 2971 Midland.

MANCHESTER: 260, Deansgate.

Telegrams: "Hiffe, Manchester." Telephone: 8970 City (4 lines).

GLASGOW: 101, St. Vincent Street, C2.

Telegrams: "Hiffe, Glasgow." Telephone: Central 4857.

PUBLISHED WEEKLY.

Subscription Rates: Home, £1 1s. 8d.; Canada, £1 1s. 8d.; other countries abroad, £1 3s. 10d. per annum.

Entered as Second Class Matter at New York, N.Y.

As many of the circuits and apparatus described in these pages are covered by patents, readers are advised, before making use of them, to satisfy themselves that they would not be infringing patents.

## CONTENTS OF THIS ISSUE.

	PAGE
EDITORIAL VIEWS	83
MAINS TRANSFORMER CONSTRUCTION. BY H. B. DENT	84
FREQUENCY MODULATION. BY JOHN HARMON	89
CURRENT TOPICS	91
GRAMOPHONE NEEDLE WEAR. BY E. M. PAYNE	93
NEW APPARATUS REVIEWED	97
BROADCAST BREVITIES	99
THE PHYSICAL SOCIETY'S ANNUAL EXHIBITION	100
LETTERS TO THE EDITOR	103
READERS' PROBLEMS	105

## INDISCRIMINATE LISTENING.

WHAT is indiscriminate listening? Sir John Reith has recently described it as one of three great prejudices against broadcasting.

In an article in the *Daily Express* last week, referring to indiscriminate listening, Sir John wrote: "When wireless is first installed it is a novelty and people probably listen too much. The novelty wears off, interest flags, and boredom results. There are those who think they should be entertained or edified or instructed according to the particular desire of the moment.

"They are annoyed if, on switching on, they hear something they do not like. They may switch on haphazard a dozen times a week, and on each occasion hear nothing which pleases them. They sometimes forget that there is wireless apparatus in almost every second home in the land, and that there are millions of others whose tastes are certainly not identical with their own.

"Programmes cannot be modelled on individual

desire. They should be studied in advance, a selection made of the items which will be of interest, and these listened to seriously."

We are entirely in agreement with the view that listeners ought not to expect that at any moment when they switch on the wireless they are going to be entertained or amused with a programme item exactly to their taste. No sane person would contract the habit of buying theatre or concert tickets without first knowing at least something about the character of the performance to be given.

## Indiscriminate Programmes.

So far, then, we are in sympathy with the views expressed by Sir John Reith, but, in calling attention to indiscriminate listening on the part of the public, has not Sir John also turned the spotlight on what, in the opinion of many, is the weakest part of the programme organisation of to-day? We refer to what can suitably be described as "indiscriminate programmes." Suppose the listener follows the advice of the B.B.C. and picks out the programme items to which he wants to listen, what does he find? Too often, we are afraid, as a result of the indiscriminate compilation of the programmes the listener finds that on very few evenings is there a programme which is mainly to his liking, and the odd bits of programme matter throughout the week which appeal to him are so short in duration as to compel him to hesitate between other engagements and remaining at home without commitments for those particular items alone.

What is needed in programme compilation is that the programmes should be less "scrappy" in character and that as much as possible should be done to avoid the devastating contrasts inflicted on us at present, where we get short snatches of high-brow educational matter, low-brow musical entertainment, modern music, jazz, and classical music all pounded into our ears in a single evening. Again, unless we are listeners with few engagements, we have to make our arrangements for listening-in some time in advance and can only do so by studying the *Radio Times* for the week. We know that only a proportion of the listening public reads the *Radio Times* and probably that proportion is made up entirely of regular users of wireless.

If the B.B.C. were to adopt the suggestion which we put forward some time ago of advertising particular programmes well in advance, we believe that much would be done to counteract the influence of indiscriminate listening, whilst it would also serve to attract many more to the ranks of the listening public.

# Mains Transformer Construction

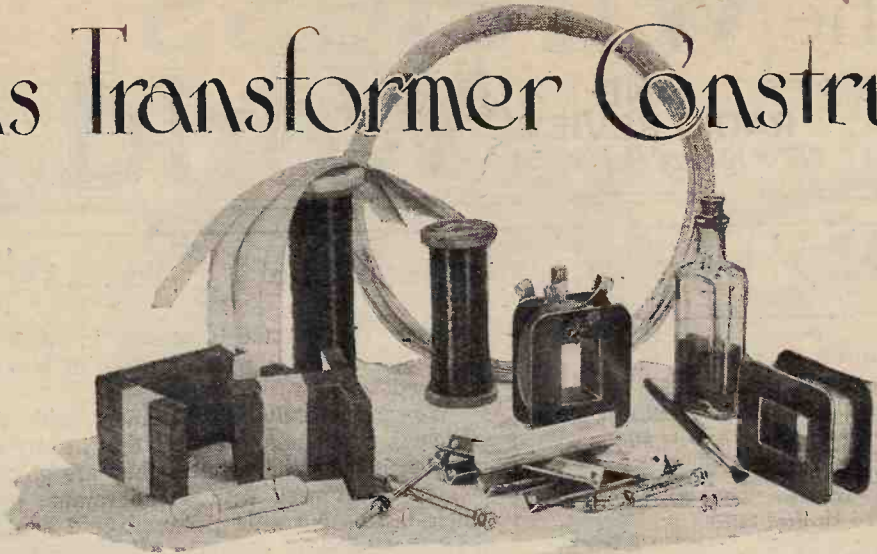

By  
H. B. DENT.

## Design No. I.—Constructional Details of a Mains Transformer for an H.T. Eliminator.

THE purpose of this article is to give some helpful information of a practical nature on the subject of constructing small power transformers of the type used in battery eliminators. As a consequence the theoretical design will not be dealt with, but the general principles are those discussed in articles which have appeared from time to time in this journal. The design prepared for this particular purpose is one which, it is hoped, will meet the requirement of those who, having a battery-operated receiver, desire to put together an H.T. eliminator, and as a further convenience, operate the output valve entirely from the A.C. mains. Since any one model will have a limited application only, especially when dealing with the diverse requirements of mains-operated sets, it was felt that readers would welcome a number of designs which will be described in these pages as facilities are afforded. By a slight modification to the design chosen to introduce this series it is possible to extend the usefulness of the component to all-mains operated sets using the indirectly heated type of valves. This point will be discussed later.

For the purpose of the present article it will be assumed that a popular type of four-valve receiver is in use, in which case the normal H.T. current is probably of the order of 15 mA. Now since the mains are harnessed the

opportunity might be taken to improve the power-handling qualities of the output stage, using a valve not hitherto possible in view of its heavy demands on the H.T., and possibly the L.T., battery. When designing the transformer this possibility was borne in mind and a six-volt winding included to supply the filament current for the last valve.

The high-tension secondary coils have been chosen to give a generous anode voltage and at the same time allow a sufficient excess to provide grid bias for the power valve. The adoption of these recommendations will demand a slight alteration to the receiver, but only the output stage is affected; the H.F. detector and first L.F. stages remaining much as hitherto.

In all there are four separate windings on the transformer, a primary, an H.T. secondary designed to give 250+250 volts at 60 mA; a 5-volt coil for supplying the filament of a Marconi or Osram U5 rectifying valve and, as mentioned above, a winding to give 6 volts at one amp. maximum.

If alternating current was supplied at a standard voltage and frequency throughout the country designing transformers would be relatively easy. Unfortunately it is impracticable to make a transformer which will function efficiently on all A.C. supply mains and certain limitation must, reluctantly, be

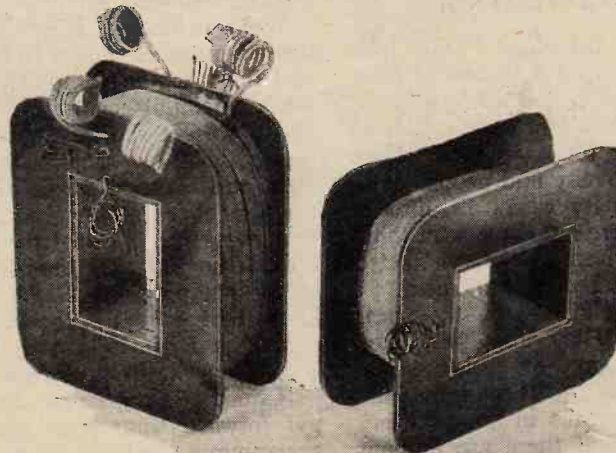

The two bobbins; one finished, the other only partly wound. Note the method of finishing off the thick wire coils.

**Mains Transformer Construction.—**

imposed. The voltage question is easily surmountable, but this cannot be said of the widely different frequencies. Fortunately the majority favour a 50 cycle supply. The transformer described in this article is suitable for use on supply mains of from 40 to 60 cycles. Having acquainted ourselves with the nature of the component it is proposed to build, attention can be given to the choice of the material. The stampings used for the core and the two special bobbins, were obtained from W. Bryan Savage, 146, Bishopsgate, London, E.C.2. In all 100 pairs of "Electra," Size No. 4 stampings, are wanted. The bobbins to fit these are listed as No. 4H, and since they cost only 9d. each it is not worth while bothering to make them up. Particulars of the wire and other small items are given in the full list of parts. It will be seen that the cost of the material is very low having regard to the fact that the component may be classified as a high-grade article.

The process of winding the coils will be greatly facilitated if a lathe, with a back gear attachment, is available. As an alternative a simple winder, something on the lines of that shown in the sketch, could be made up. Winding without the aid of some simple mechanism to hold the bobbins will be found rather tedious. The first coil to tackle is the primary. This is wound in two equal parts, half being put on each former. First drill a small hole in each of the end cheeks, one for the beginning and the other for the finish of the coils. These holes must be drilled through the shorter sides of the rectangular former. If the leads come through a long side they would be obscured by the iron when the core is assembled. One hole is on a level with the inside surface while the other, or exit hole, is  $\frac{1}{4}$  in. up. The primary is wound as tight as possible, with turns touching and in layer form. A good example is to be found in the manner cotton is wound on its reel. Between each layer of wire place a layer of thin paper which can conveniently be cut into strips a fraction over an inch in width. As the former is one inch wide this will allow the paper to curl up slightly against the inside of the end cheeks and assure good separation between the layers of wire.

**Insulation Between Primary and Secondary.**

Having wound on the correct number of turns to suit the particular supply voltage on which the transformer will be used, this former can be laid aside and the other treated in like fashion. The following windings will be required for various supply voltages: 200 volts, 600 turns each bobbin; 220 volts, 660 turns; and 240 volts, 720 turns each bobbin, No. 28 enamelled wire being used for this purpose. In cases where the supply is of the order of 100 volts, two courses are open. The primary winding may be chosen for twice the supply voltage and the two bobbins later connected in parallel, or, a larger gauge of wire can be used and the correct

number of turns for the series-connected arrangement wound on each former. Assuming the adoption of the latter course, as this lightens the labour, No. 24 S.W.G. enamelled wire will be required for 100-, 110- and 120-volt mains. The turns on each bobbin will be 300, 330 and 360 respectively. As the area occupied will be somewhat less than in the case of the higher voltage windings the exit holes for the finishing ends of the coils should be drilled slightly lower.

The next point to consider is the insulation between the primary and the high voltage secondary, which is wound next. Three layers of "empire cloth" or similar insulating material, a fraction of an inch wider than the inside of the former, will suffice. It is essential that particular attention should be given to this operation, as it would be court- ing trouble if any cracks or crevices

were left down which the fine wire of the secondary could fall and contact with the primary. Possibly it would be well to give the covering a coat of shellac varnish, thereby ensuring a perfect seal between the cheeks of the bobbin and the covering.

The secondary is divided also into two equal parts, each former carrying 1,530 turns of No. 36 enamelled wire. To wind this in absolute layer form, with each

- MATERIAL FOR TRANSFORMER.**
- 9 doz. pairs transformer stampings, "Electra," size No. 4 (Savage).
  - 2 Bobbins for above, No. 4H (Savage).
  - 2 feet  $\frac{1}{2}$  in. angle brass.
  - 1 foot 2BA screwed rod.
  - 2 doz. 2BA lock nuts.
  - 1 doz. 4BA  $\frac{3}{4}$  in. countersunk screws.
  - 2 doz. 4BA lock nuts.
  - 1 doz. double-ended soldering tays (4B24).
  - 8 $\frac{1}{2}$  ozs. No. 28 enamel wire.
  - 7 ozs. No. 36 enamel wire.
  - $\frac{1}{2}$  lb. No. 20 D.C.C. wire.
  - Quantity insulating cloth or tape.
  - Approximate cost of material 17s. 6d.

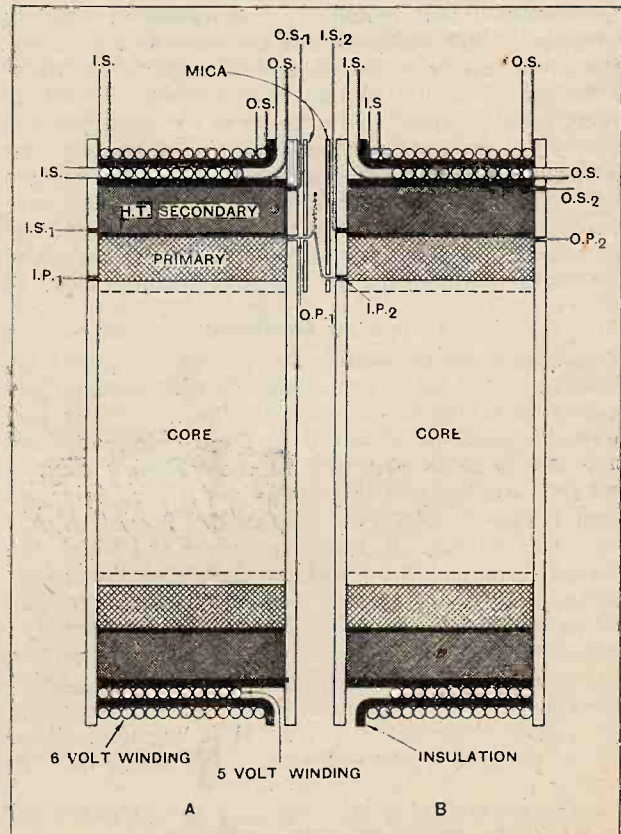

Sectioned drawings of the two bobbins showing the disposition of the various windings.



**Mains Transformer Construction.—**

turn touching its neighbours, is expecting too much from any hand-operated winding mechanism, but it will be perfectly satisfactory if the turns are run on as evenly as possible with the apparatus available. The writer adopted this course, and found that a good coil could be made up by winding 160 turns in this manner and then putting on a layer of thin paper. This is followed by a further section of 160 turns, then more paper, and so on until the full number of turns has been wound on.

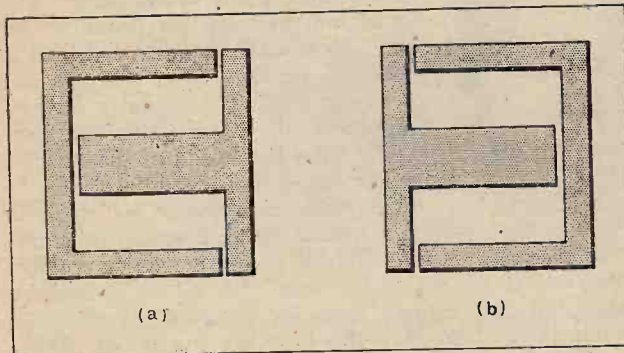

When assembling the core reverse the order of each pair of stampings. If (a) depicts the first pair then the second pair should be as in (b).

Before commencing to wind this coil the exit hole for the finish of the winding could be drilled through the side cheek  $\frac{1}{4}$  in. above the surface of the insulation over the primary. Incidentally, the direction of winding should be kept the same throughout, and as a guide for future reference it would be well to engrave an arrow on the outside of the bobbins showing this. Thin wire is very fragile and inclined to break at the least provocation. As a precautionary measure the beginning, and the finish of the winding should consist of much stouter wire. This will prevent any likelihood of the wire breaking off where it passes through the holes on the side cheeks. A few turns of No. 28—the primary wire—might be used and the No. 36 gauge soldered to it.

**Testing for Continuity.**

When the two secondaries have been completed the windings should be covered with insulating material and finished in the manner described above. Similar precautions should be observed in these cases, although there will be little likelihood of the following winding settling down between the cheeks and the covering, as much thicker wire will be employed. Insulation of a high order is essential, however, as the coil which follows the secondary is the filament supply for the rectifying valve. Readers who are familiar with valve rectifier circuits will appreciate this point, but for the benefit of those not so well versed on these matters it is well to bear in mind that the filament of the rectifying valve becomes the H.T. positive, while the centre point of the high voltage secondary coil is the H.T. negative. Thus there is a considerable difference in potential between the two coils.

Before proceeding further it would be well to test the coils for continuity, using a  $1\frac{1}{2}$ -volt cell and telephones, or a galvanometer. It is highly improbable that any-

thing will be found amiss, as one advantage of employing enamelled wire is that a break would have been spotted during the process of winding. However, it is a safety measure well worth adopting.

For the next coil we require 16 turns of No. 20 D.C.C. wire on each bobbin. This is wound as a single layer with turns touching. The beginning of the wire may be passed through a hole in the cheek through which the starting ends of the other coils pass. This applies to one bobbin only. For explanatory reasons we will call this bobbin A. Reference to the small sketch, showing the disposition of the coils on the bobbins, will explain the reason. The overall width of the two formers does not permit any appreciable separation between them when assembled on the core; and if the ends which we will call OP<sub>1</sub> and IP<sub>2</sub> were brought out through the cheeks, which lie adjacent, the core stampings would not fit snugly together. An air gap in the magnetic circuit is highly undesirable, as it tends to lower the efficiency of the transformer. Therefore, when finishing the winding on bobbin A, bring the end out on the inside of the cheek. It is not difficult to arrange, as the wire can be anchored in position by binding with stout cotton. Likewise the beginning of the coil on bobbin B should come out on the inside of the cheek, but its end can pass through a hole in the other face. A coating of shellac may be applied if desired, but it must be allowed to set hard before commencing to wind the next coil.

The final winding supplies current to the output valve, and as a consequence there will be a difference in potential between this and the preceding coil equal to the high tension supply to the anodes of the valves. Particular care is required, therefore, in insulating these two coils. In addition to the layers of "empire cloth," place a strip of mica across the coil so that it completely isolates the end of the coil which is brought out on the inside face of the end cheek. Its function is to form an artificial cheek and assure good insulation between the two coils at the point where the wire is not fixed so securely

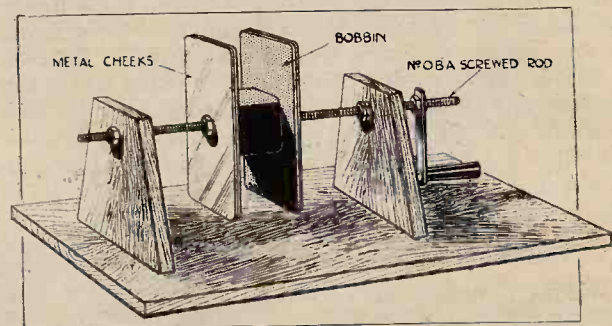

Layout of the coil winder mentioned in the text. Metal end plates are required to hold the bobbin and prevent bulging.

as would be the case if it had been convenient to pass the end through a hole in the side of the former.

Now for the final winding. This consists of 18 turns of No. 20 D.C.C. wire—on each former. The method of commencing and finishing this coil is the same as that described for the preceding one. The windings are now completed to conform with the specification outlined at the beginning of this article. If particularly

**Mains Transformer Construction.—**

desired the six-volt winding can be replaced by one suitable for the supply of current to three indirectly heated valves. In this case 12 turns of No. 18 D.C.C. wire should be substituted for the 18 turns of No. 20 D.C.C. on each bobbin. A thin coat of shellac, and finally a few turns of insulating cloth, to impart a pleasing finish,

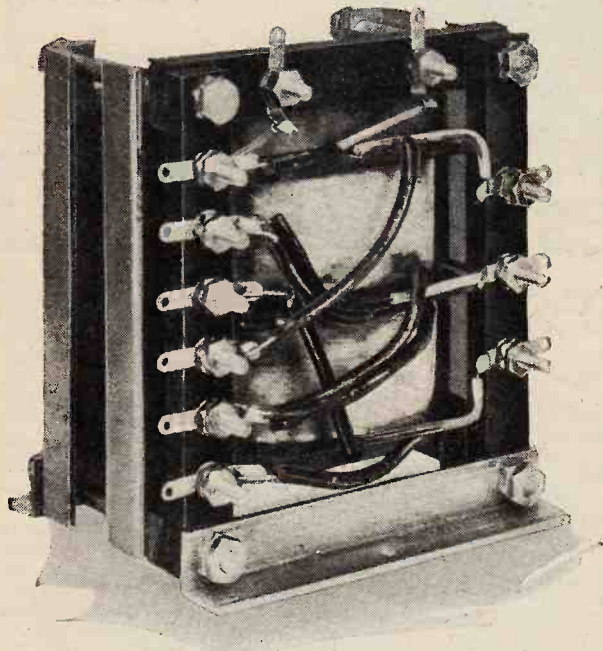

This view of the finished transformer shows clearly the manner in which the terminal battens are attached to the holding-down bolts.

complete the winding, and attention can be given to the assembly of the core.

This is built up with thin stampings cut from specially prepared steel, on one side of which is a thin layer of insulating material. They consist of "T" and "U" shaped pieces, one of each forming a pair, and giving the distinctive shape to the core. The two bobbins should be placed side by side, with the long side of the rectangular core spaces at right angles to the bench. If the winding has been carried out in accordance with the details given here the arrows showing the direction of winding will both point in the same direction with all leads coming out from the top. If there is any difficulty in identifying the various leads, test through with a battery and telephones. Now cut two strips of mica 2½ in. long and ¾ in. wide and drill a small hole in each. One hole, through which should be threaded the OP<sub>1</sub> lead, will be ¼ in. up from the lower edge, and the other will be about 1/16 in. up to accommodate the IP<sub>2</sub> lead. Cut these leads, leaving about 1 in. of wire, remove the enamel carefully, using a piece of emery cloth, and solder together. When the two bobbins are butted together the primary join will be protected by the two mica strips.

The core can now be built up by inserting the tongue of a "T" piece into the core opening and following by a "U" piece from the opposite side. The order of assembly must be reversed in each layer. For example,

if the first "T" piece is inserted from the right-hand side the second "T" piece goes in from the left. This is explained diagrammatically in the sketch of the core stampings. If (a) is the first pair, then the second pair should be arranged as in (b) and so on until as many pairs as the space will hold have been assembled. If the core is built up correctly it should be possible to accommodate 100 pairs. To clamp the iron, pieces of ½ in. angle brass, 4 in. long, can be used. Holes to pass 2BA screwed rod should be drilled 3/8 in. apart. This will allow sufficient clearance for the rods. The brass rods must not touch the edge of the laminations, otherwise all the advantages of using insulated stampings will be lost. Incidentally, when assembling the core keep the insulated sides of the stamping the same way up throughout, the object being to maintain a layer of insulation between each. Terminal strips, cut from paxolin, or ¼ in. thick ebonite, can be clamped on to the extension of the holding bolts and small terminals, or ¼ in. No. 4BA screws and nuts, used to finish off the transformer. The method of assembling these is shown clearly in the illustration of the finished model.

**Voltage Regulation Curve.**

Some practical tests were made with the experimental model and curves taken of the output voltages on load. These are shown in the graph reproduced here. At the time of test the mains voltage was down to 230, whereas its nominal value is 240 volts. All output voltages are thus reduced in the same proportion.

It was a pleasant surprise to find that this particular model was absolutely silent when connected up; generally a slight hum is present, which is brought into being by looseness in the core. The stout walls of the bobbins

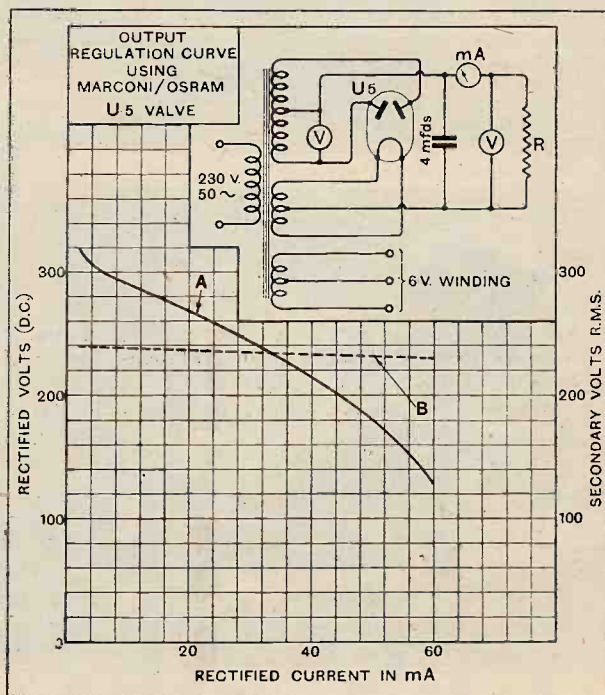

Output voltage regulation curves. The full-line curve A shows the rectified voltage under load while the curve B is the corresponding R.M.S. secondary voltage.

**Mains Transformer Construction.**—

enable the iron to be packed much tighter without damage to the coils than appears possible with any other method of assembly.

The voltage regulation of the H.T. secondary may be regarded as satisfactory, since the variation between no-load and full-load—in this case 60 mA—is of the order of 7% only. No change in conditions in the H.T. circuits could be discerned when current was drawn from the 6-volt winding. On voltmeter load only, the voltage was 6, at 0.5 amp. it dropped to 5.85 volts,

and at 1 amp. to 5.7 volts. This is equivalent to a 5% change from open circuit conditions—an entirely satisfactory regulation.

Readers having access to a high range D.C. voltmeter and a milliammeter might well consider taking a rectified voltage characteristic curve, as shown at A on the graph. This will be found of inestimable value in calculating the values of voltage-dropping resistances. The requirements of the set will be known, of course, since it is assumed that batteries have been employed hitherto.

## TRANSMITTERS' NOTES AND QUERIES

**Irish Amateurs.**

The Wireless Society of Ireland has appointed a sub-committee to consider matters affecting membership, especially with a view to increasing the scope of the Society and forming branches in the principal provincial towns. A writer in the *Irish Radio News* advocates a very considerable broadening of the membership to include not only amateur experimenters and transmitters, but listeners, traders, and broadcast artists, each section conducting its own meetings and business but having its representatives on the governing council. By this means he considers that all shades of wireless interest would be united and radio activity spread over the whole country instead of being confined almost exclusively to the neighbourhood of Dublin.

**French Morocco.**

CN 8MC, operated by Dr. G. Veyre, at 83, Avenue de General Moinier, Casablanca, Morocco, will relay the programme transmitted from Rabat, Morocco, the French P.T.T. Station, four times a week

on 43.60 metres, the times being: Tuesday, 20.00-21.00; Wednesday, 20.30-22.30; Saturday and Sunday, 12.30-14.00 G.M.T.

**The Curse of Raw A.C.**

The use of unrectified A.C. for amateur transmission is distinctly prohibited, under the terms of their licences, to British amateurs and, we believe, similar restrictions are imposed in all Continental licences, yet the interference caused by the use of unrectified or badly smoothed A.C. is still a source of great trouble on the 7,000 kc. and 14,000 kc. wavebands. British amateurs in general are careful to observe the regulations in this respect, but there are, unfortunately, Continental stations causing interference, especially on the 7,000 kc. band, by careless use of raw A.C.

We believe that most of the offenders are, in fact, unlicensed stations, but their interference is so great that many British amateurs have almost given up working on the narrow 42-metre band. The combined efforts of the R.S.G.B. and the R.E.F. seem unable to bring about any reduction of the nuisance. Probably the offending stations, being unlicensed, are hard to trace, but in the interest of amateurs in general no pains should be spared to induce them to "play the game" and to remember that the restrictions on amateur activities are even now considered rather drastic, and that any infringement of regulations or of the desirable courtesy of the ether, tends to tighten up these restrictions.

**On the Riviera.**

Mr. M. W. Pilpel (G 6PP) will be spending a month in Nice, and hopes to obtain some interesting notes on the comparative difference in conditions of reception in the South of France. He will probably be listening on most afternoons and some evenings up to the third week in February, and will be willing to report to any British stations on their 7 or 14 mc. signals, if they will write to him c/o Mrs. Schmidt, 14, ter. rue Buffa, Nice, France.

**The Havoc of the Storm.**

The gale on the night of Sunday, 12th, caused considerable havoc among amateurs' aerials. We hear that the 50ft. steel mast at G 5AR—the station of Mr. E. D. Ostermeyer, of South Woodford—which for six years has withstood every onslaught, snapped at the height of the gale and fell, carrying away trees and his neighbour's aerial in its wake. It may, therefore, be some time before G 5AR is again "on the air," and his neighbour lamented the destruction of his own aerial just before Radio Week.

**New Call-Signs and Changes of Address.**

G 5FA J. A. Farrer, The Willows, The Park, Buxton.  
G 5QP J. V. Parsons, 24, Upper Holland Rd., Sutton Coldfield. (Change of address).  
G 5NR (ex 2AJR), E. G. Nurse, 1, Cambridge Rd., Hammersmith, W.6.  
G 5RJ W. G. Rose, 46, Trevinice Rd., London, S.W.20  
2BIL E. W. Heron, 60, Alexandra Park Rd., London, N.10.

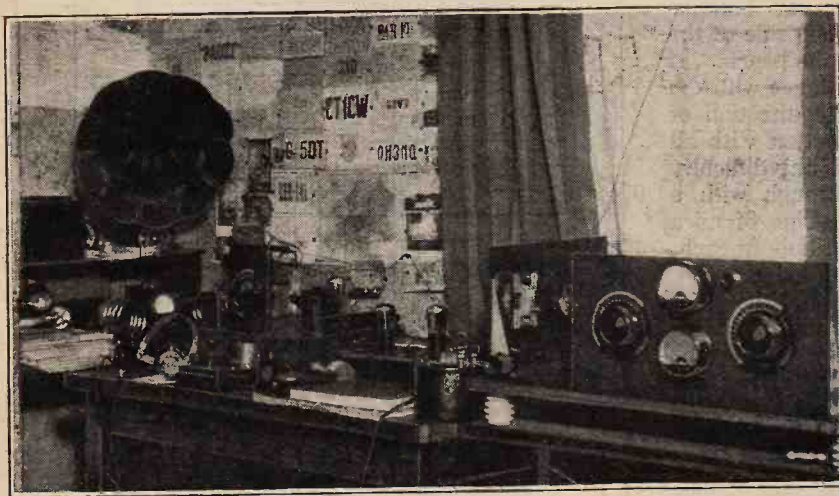

A COMPACT STATION.—G 2BY owned by Mr. H. C. Whatley at 37, Paddenswick Road, Hammersmith, W.6. The input is 10 watts in a T.P.—T.G. circuit. The H.T. supply is 400 volts maximum from an M-L rotary converter driven from accumulators.

# THE BALANCE



**AN  
AMPLION  
PRODUCT**

**A** balanced armature movement of great sensitivity able to handle considerable volume and reproduce with high efficiency all audio frequencies. Adaptor plate to fit varied chassis types, and fitted with terminals for three alternative values of impedance. Gives splendid results in combination with any valve set, and can be used with pentode valve without special transformer.

**NO SPECIAL  
TRANSFORMER  
NEEDED WITH  
PENTODE VALVE**

**GRAHAM AMPLION LIMITED**

25 26, Savile Row, London. W.1

royds

# LARGE UNIT CELLS

## FOR POWER WITH ECONOMY



### "INSIDE KNOWLEDGE."

An informative little booklet on the correct use of Radio Batteries, fully illustrated, written in simple language and containing, in addition, a full list of Siemens Batteries, with details and prices. From your dealer, or direct from Siemens Brothers & Co. Ltd., Woolwich, S.E.18.

# SIEMENS

## SUPER - RADIO

SIZES AND PRICES.		
POPULAR TYPE		
No. 1200.	60 volts.	8/-
No. 1202.	100 volts.	13/-
POWER TYPE.		
No. 1204.	Power 60 volts.	13/6
No. 1206.	Power 100 volts.	22/6
GRID BIAS.		
No. G.9.	9 volts.	1/6



FOR sets using more than one Power Valve, a Super-Power Valve or a Pentode, there is nothing to equal the extra large capacity Siemens Super-Radio Battery. This battery is composed of extra large unit cells, the normal discharge rate being 15 to 30 milliamps. It is supplied complete with two connecting tabs for use with flexible connecting wires, and fitted with spring clip terminals at 0 (-), 25, 36 and 50 volts (+).

No. 1035, 50 volts - - PRICE 25/-

SIEMENS BROTHERS & CO. LTD., WOOLWICH, S.E.18.

Telephone: Woolwich 1161.

# Frequency Modulation

A Possible Cure for the Present Congestion of the Ether.

By JOHN HARMON.

It is well known that as soon as a broadcast station begins to speak its carrier wave becomes bordered by a halo of nearby frequencies, and the station, which is a mere spectrum line in the ether when silent, becomes a spectrum band when its jazz band begins.

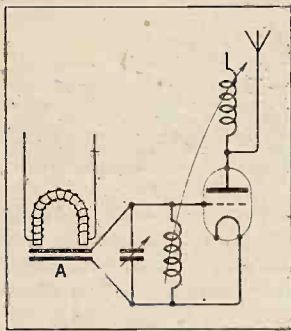

Fig. 1.—Speech currents vary the capacity of the condenser A and so the transmitter is modulated at speech frequency.

This frequency band extends over at least 5 kilocycles on either side of the carrier wave, so that each station requires a space 10 kilocycles wide for its exclusive use. This position was all right five years ago, but to-day the stations of the world have used up all the available frontage and there is no room for further extensions.

Accordingly, inventors have been intent on the problem of communications on narrower frequency channels. No improvement is conceivable while the principle of modulating the amplitude of the carrier wave remains, and so a completely different method has been tried in which the carrier frequency is wobbled while the amplitude remains constant.

### Wobbling the Carrier Wave.

Imagine an oscillator set up as in Fig. 1. In parallel with the tuning condenser a small special condenser is inserted, composed of two parallel plates, one of which consists of the diaphragm of a magnetic telephone. If a 1,000-cycle oscillation be impressed upon the electromagnet the motion of the diaphragm will vary the capacity of the small condenser and the frequency of the carrier wave will alter 1,000 times per second, as in Fig. 2, while the magnitude of the frequency change will be proportional to the magnitude of the A.C. current which flows through the windings of the electromagnet.

Hence the usual picture of a carrier wave accompanied by two side-bands (Fig. 3) is replaced by a blurred carrier wave of unvarying amplitude, and the

important fact emerges that the transmitting station may now occupy a much smaller frequency channel.

Indeed, we can make the wobble as small as we please by diminishing the capacity of the two-plate condenser in Fig. 1. But the impressed wobble must be made considerably greater than the unavoidable wobble of the carrier wave itself.

### A New Conception.

A wave of this kind is a new conception in wireless and has some peculiar features. If we listen to it on an oscillating detector we can never get a silent point; instead, we hear a gliding tone similar to those given by the Parlophone gramophone test records, where a note sweeps rapidly up and down the scale, producing a sound somewhat similar to the chirp of a bird.

Again, though a wave with amplitude modulation can be represented as a carrier accompanied by two side-bands, no such analysis can be got on a wobbling wave.

### Reception.

If such a wave is received on a set tuned to the undisturbed frequency of the carrier, practically nothing is heard since the wave is sweeping back and forward with constant amplitude across the summit of the resonance curve, in which region the sensitivity to small frequency changes is least. The best place to receive the signal is on the steepest part of the slope (Fig. 4), so that the frequency changes may give rise to the maximum changes in amplitude.

Thus, if a single-tuned circuit is used for reception, the ratio of the reactance of the coil to its resistance, i.e., the coil magnification, being 100, which is a figure corresponding to a rather poor coil, the resonance curve at 300 metres is shown in Fig. 5 (a). If the incoming

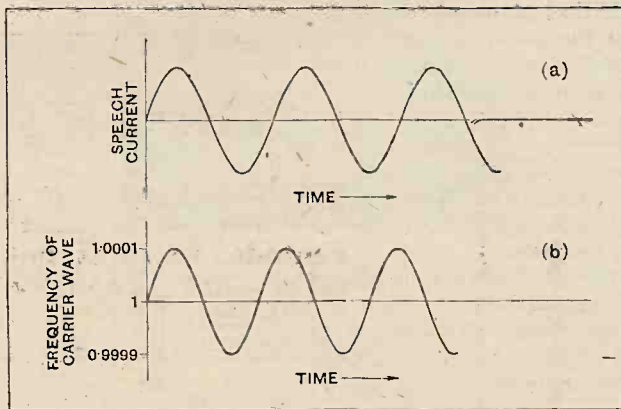

Fig. 2.—(a) Represents the A.C. current flowing through the windings of the electromagnet of Fig. 1; (b) represents the resulting frequency variations in the carrier wave.

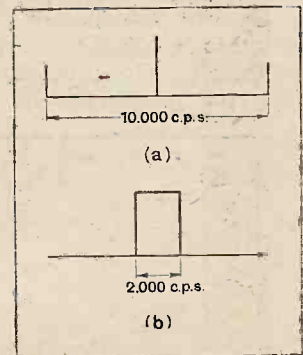

Fig. 3.—Illustrating (a) amplitude modulation; (b) frequency modulation.

**Frequency Modulation.—**

wave is received at the point A on the curve, then a frequency wobble of 2 kc. in either direction will be required to change the amplitude of the received signal by 20 per cent.

Fig. 5 (b) gives the resonance curve for the same wavelength of 300 metres when a 2-stage H.F. receiver is used having three tuned circuits, each coil having a magnification of 100. In order to obtain a modulation of 20 per cent. of the signal amplitude the wobble need only be 1 kc. each way. Hence the transmitting station need occupy only a frequency channel 2 kc. in breadth instead of the 10 kc. required with the usual system of amplitude modulation.

But we can go much farther by using a local oscillator at the receiving end to give a beat note of, say, 50 kc. with the incoming wave, and amplifying this intermediate frequency. If the intermediate amplifier has three tuned circuits, the magnification of each coil being 100, we get the resonance curve of Fig. 5 (c),

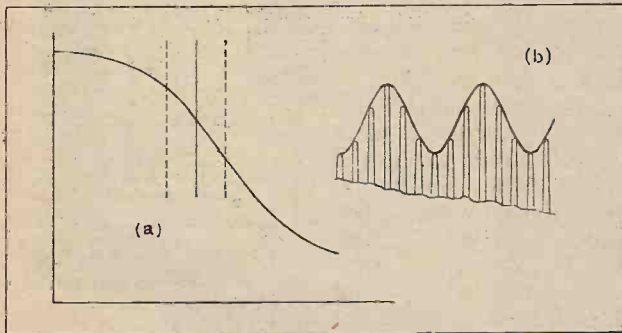

Fig. 4.—As the carrier frequency oscillates between the dotted lines (a) the received amplitude will be modulated as in (b).

and a 50-cycle wobble is enough to give 20 per cent. amplitude modulation.

Accordingly, we must conclude that frequency modulation is quite practicable from the point of view of building a suitable receiver, and it only remains to consider the necessary conditions at the transmitting end.

**Quartz Control.**

When a narrow-frequency band is used it is desirable to prevent accidental wandering of the carrier frequency, and a more precise method of wobbling the frequency is required than the one already described.

For this purpose a tuned-anode circuit is used, as in Fig. 6, and a slice of quartz, placed between cover plates, is inserted in the grid circuit; as is well known, a system of this kind oscillates at the natural frequency of the quartz plate, and the frequency remains constant to a few parts in a million.

The frequency may be varied slightly by loading the quartz by a coil in parallel and tapping part of this coil to earth through a resistance.

Accordingly, if this resistance is varied at speech frequency the oscillator undergoes frequency modulation. The resistance may be replaced by a valve (Fig. 6 (b)) whose grid is controlled by speech currents, and the varying impedance of the valve acts in the same way as the variable resistance in Fig. 6 (a).

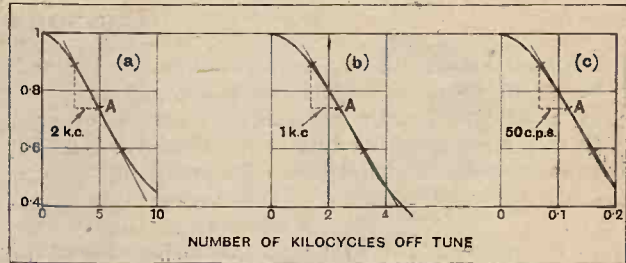

Fig. 5.—Transformation of frequency modulation into amplitude modulation with different types of receivers; in each case the magnification of the coil is 100 and the received signal is on 300 metres. (a) Receiver with single tuned circuit; (b) two-stage H.F. receiver with three tuned circuits; (c) superheterodyne receiver with three intermediate circuits tuned to 50,000 c.p.s.

The frequency modulation so produced is necessarily small, since the quartz plate is equivalent to an inductance of about 100 henrys in series with a capacity which is only a fraction of a micro-microfarad, so that the loading coil does not produce much change in the total inductance. However, it is possible to change the frequency by as much as 1 kc. in a 1,000-kc. wave.

It should be noted that this change is produced with no change of the amplitude of the H.F. oscillations. Readers who wish for more complete details of these inventions will find them in Patent Specifications 292,469, 293,803, and 296,678. The methods do not seem to have attracted attention in the wireless Press up to the present, but they are worth studying, and experiments on similar lines are well within the resources of the amateur.

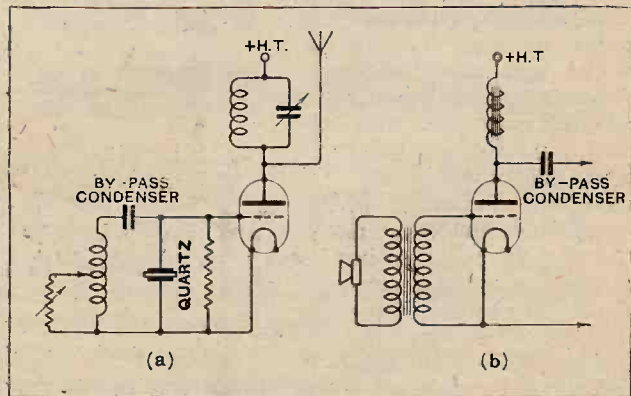

Fig. 6.—To prevent wandering of the carrier frequency, a tuned anode circuit is used together with a quartz-plate oscillator in the grid circuit (a). The resistance in (a) may be replaced by a valve as in (b) whose grid is controlled by speech currents.

**WIRELESS THEORY SIMPLIFIED.**

Part XVIII of this series dealing with Dynamic Resistance of Tuned Circuits will appear in next week's issue.

# Current Topics

## EVENTS of the WEEK in BRIEF REVIEW

**ANOTHER POLYGLOT STATION.**  
The example set by PCJ, Eindhoven, in announcing items in several languages will probably be followed by Kalundborg in the near future.

**WEEKDAY WIRELESS IN CHURCH.**  
Argyle Congregational Church, Bath, is being equipped with a wireless set for the daily reception of the morning religious service from Daventry. Passers by are invited to come in and listen.

**ANOTHER GERMAN GIANT.**  
A new "super broadcasting station" for Germany is to be erected at Muelhacker, mid-way between Stuttgart and Carlsruhe, and within thirty-seven miles of Strassburg. French listeners are beginning to fear that the new Strassburg station may be within the interloper's wipe-out area.

**ANTI-INTERFERENCE CLUB.**  
According to our Paris correspondent, a club has been formed in Campagnole (Jura) for the express purpose of suppressing interference to broadcast reception caused by noisy generators and other sources of "perturbation."  
If the club ultimately fulfils its purpose, remarks our correspondent, it is assured of a very long life.

**AN OBLIGING TRAMWAY DEPARTMENT.**  
The Nottingham Tramways Department is making special efforts to overcome interference caused to broadcast listening by defective "collectors" working on the overhead current wires. Experiments are to be conducted with an improved form of collector which has been found successful in Blackpool and Birmingham.

**MAINS SETS ON TRAINS.**  
Living up to their reputation as the most enterprising of the world's railway systems from a radio point of view, Canadian National Railways are now installing mains-operated wireless receivers on their Trans-Continental expresses. The power is supplied from a motor generator driven by the car lighting batteries. It is stated that the new system will considerably reduce maintenance costs.

Another innovation is the use of electric gramophones for use in parts of the line, such as in the Rockies, where radio reception cannot be relied upon to give good quality.

**GERMAN SHIP-TO-SHORE TELEPHONY.**  
The famous German coastal station at Norddeich is to be equipped with short-wave telephony apparatus for communication with fishing fleets in the North Sea and with German ships in all parts of the world.

**POST OFFICE PATIENCE.**  
In the case of a wireless "pirate" fined at Pudsey, evidence was given that the Post Office sent three warning notices before taking action.

**THE UPWARD TREND.**  
On January 1st Germany's licensed listeners numbered 3,066,682, making an increase of 431,115 during the past year. The British increase over the corresponding period was 328,344.

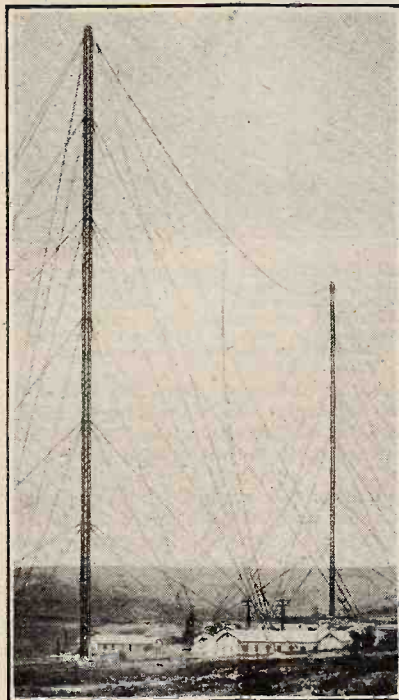

**HAVE YOU HEARD THIS ONE?** The Turkish broadcasting station at Stamboul, which operates on 1,200 metres with a power of 5 kw.

**TELEPHONY FROM ARCTIC TO ANTARCTIC.**  
A new wireless record has been established jointly by the Byrd expedition in the South Polar regions and the Soviet station in Franz-Josef Land, believed to be the most northerly human outpost. The feat was accomplished on Sunday, January 12th, when, according to a Moscow message, the Soviet operator gave a telephone description of an Arctic dawn. A reply came from Commander Byrd's operator, who described an Antarctic nightfall. The distance traversed was 12,500 miles.

**A HINT TO THE B.B.C.**  
Havana broadcasting stations are forbidden to transmit after 10.30 p.m., the object being to allow listeners to tune in the American stations.

**R.M.A. GIFT TO THE BLIND.**  
Over £10,000 has been contributed by listeners in response to Mr. Winston Churchill's appeal on Christmas Day for the "Wireless for the Blind" Fund.

The Radio Manufacturers' Association has decided to present 1,000 complete wireless sets, representing a retail value of £10,000.

**TEN YEARS FOR ILLICIT TRANSMITTER.**  
Alexander Pertini, the Italian lawyer who was recently arrested at Nice, charged with broadcasting anti-Fascist news from his villa there, has been sentenced in Rome to imprisonment for ten years and nine months, to be followed by three years of police supervision.

**NEW RADIO SHOWROOMS.**  
London's latest radio landmark is Roxburgh House, 283, Regent Street, W., which houses the new West End showrooms of Burndep Wireless (1928), Ltd. It would have been difficult to choose a site nearer the centre of musical London, and the designers have availed themselves of the opportunities presented by introducing a modern scheme of decoration and furnishing which should satisfy the most discriminating visitor. A large selection of Burndep radio-gramophone instruments are available for demonstration.

**HIDDEN ADVERTISEMENTS COMPETITION.**  
The competition announced in our issue of January 8th brought entries from all parts of the country and from the Continent. The following are the prize-winners:—

- 1st Prize (value £7 10s.).—Mr. Walter Beck, 13, Houlditch Road, Leicester
- 2nd Prize (value £5).—Mr. H. A. Fothergill, 9, Mosley Street, Nelson, Lancs.
- 3rd Prize (value £2 10s.).—Mr. William Branston, Lampool Maresfield, Uckfield, Sussex.

Consolation prizes (each to the value of £1) are awarded to the following:—Mr. F. Sytor (Antwerp), Mr. J. Godeck (Worthing), Mr. Henry R. Kiddle (London, S.W.9), Mrs. M. Diggle (Salford), Mr. H. J. Layzell (Herne Bay).  
The following are the correct solutions:—(1) Brownie Wireless Co. (G.B.), Ltd.; (2) British Institute of Engineering Technology; (3) Sheffield Magnet Co.; (4) Dubilier Condenser Co. (1925) Ltd.; (5) Igranic Electric Co., Ltd. (6) Claude Lyons, Ltd.



**CHINA FRIGHTENS THE CABLE COMPANIES.**

Several high-power wireless stations are now being erected in China for communication across the Pacific, and the cable companies covering this route are growing apprehensive. According to a Shanghai message, China's radio zeal is being inflamed by American capital.

**BELGIUM'S BEAM STATION.**

The Belgian Government has concluded a contract for the establishment of a high-power short-wave station at Ruysselede, near Bruges, for international telegraphy and telephony communication. The station will be built on the Marconi beam system and will be primarily intended for working with the Belgian Congo. It will later be used for services to South America and Japan.

**POLICE AND CAR WIRELESS.**

According to several daily papers, the police view with alarm the advent of a wireless-equipped motor car, a saloon model of which is expected to be in production by August next. It is stated that the police base their anxiety on the probability that the new car will become popular with gangs of criminals.

Are our contemporaries forgetting that anyone can "equip" his car with wireless at a moment's notice by taking a portable?

**SIR RICHARD GLAZEBROOK.**

The Council of the Institution of Electrical Engineers have elected Sir Richard Tetley Glazebrook, K.C.B., D.Sc., F.R.S., to be an honorary member of the Institution. Sir Richard Glazebrook was the first Director of the National Physical Laboratory, and was a member of the Technical Committee inquiring into the Imperial Wireless Scheme.

**A RADIO RAILWAY.**

"Radio Features" is the title of a new monthly publication issued by the radio department of the Canadian National Railways. This brightly written and illustrated journal, which is distributed to passengers on the company's system, gives a résumé of the month's programmes with biographical details concerning the broadcasting artists besides interesting facts relating to the operation of the radio service.

There are now seventy-two cars permanently wired for radio reception, and in nearly all cars now under construction provision is made for the installation of wireless gear. A staff of nearly sixty uniformed operators specialise in the control and maintenance of the train receiving equipments.

**DR. DE FERRANTI.**

The death of Dr. Sebastian de Ferranti at Zurich on January 13th will be widely regretted. To the majority of wireless amateurs Dr. de Ferranti's name has become a byword through its association with the famous firm of transformer manufacturers; by electrical engineers generally, however, Dr. de Ferranti will also be remembered for his pioneer work in

electricity supply. Born in Liverpool in 1864, Sebastian Ziani de Ferranti spent most of his life in this country. As far back as 1886 de Ferranti's help was enlisted in the development of an electric lighting supply for the West End of London, and four years later he set up a

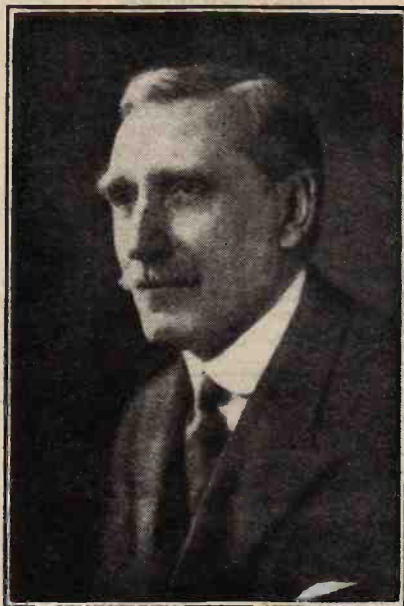

**AN ELECTRICAL PIONEER.** The late Dr. Sebastian de Ferranti, F.R.S., whose death occurred last week. Besides being associated with transformer design and manufacture, Dr. de Ferranti was an authority on electrical power supply.

generating station at Deptford with two 1,500 h.p. sets with a pressure of 2,500, which he transformed up to 10,000. As there was no form of meter in those days capable of registering such a pressure he was reduced to the expedient of connecting up a hundred 100-volt lamps in series, judging that the correct voltage was reached when the lamps gave their normal brightness!

**FORTHCOMING EVENTS.**

- WEDNESDAY, JANUARY 22nd.**  
 Edinburgh and District Radio Society.—At 8 p.m. At 16, Royal Terrace. Short-wave Transmission.  
 Golders Green and Hendon Radio Society.—At 8.15 p.m. Informal meeting at 45, Redington Road.  
 Institute of Wireless Technology.—At 7 p.m. At the Engineers' Club, Coventry Street, W. Lecture: "Notes on the Fading of Wireless Signals," by Mr. A. M. Houston Fergus.
- THURSDAY, JANUARY 23rd.**  
 Slade Radio (Birmingham).—At the Parochial Hall, Broomfield Road, Erdington. Test of members' loud speakers.
- MONDAY, JANUARY 27th.**  
 Newcastle-upon-Tyne Radio Society.—At 7.30 p.m. In the English Lecture Room, Armstrong College. Lecture: "The Construction and Theory of a Push-pull Amplifier," by Mr. J. Rush.
- TUESDAY, JANUARY 28th.**  
 Thornton Heath Radio Society (with South Croydon and Whitgift Middle Schools Wireless Societies).—At 8.15 p.m. At St. Paul's Hall, Thornton Heath. Cinematograph film exhibited by Messrs. Siemens, Ltd.

When in 1910, Dr. de Ferranti delivered his address as President of the Institution of Engineers, he boldly predicted a time when all fuel used for heat and power would be transformed into electrical energy and distributed throughout the country from a few large generating stations.

He was awarded the Institution's Faraday Medal in 1924, and in 1927 was elected a Fellow of the Royal Society. He received the honorary degree of D.Sc. from the University of Manchester in 1911.

**CLUB NEWS.****Forewarned is Forearmed!**

Muswell Hill is one of the few remaining districts having a D.C. electricity supply, and in view of the fact that a change-over to A.C. will inevitably take place, the lecture by the Westinghouse Co., which was given before the Muswell Hill and District Radio Society on January 8th, was of especial interest; dealing as it did with the theory and practical uses of the well-known Westinghouse metal rectifier. A comprehensive series of lantern slides accompanied the lecture and a cinematograph film, illustrating in an ingenious manner the process of the rectification of an alternating current, was afterwards shown. Hon. Secretary, Mr. C. J. Whitt, 39, Coniston Road, London, N.10.

**The "Slade Radio" Song.**

An item which caused considerable interest and amusement at a recent meeting of Slade Radio (Birmingham) was the "Slade Radio" song, which has been written by one of its best-known members.

A very good programme has been arranged for the next three months and should prove interesting to all members.

Details of the Society will be forwarded on application to the Hon. Secretary, 110, Hillaries Road, Gravelly Hill, Birmingham.

**Difficulties Dissolved.**

"Faults Which Have Baffled Me" was the subject of an animated discussion between members of the Wembley Wireless Society at a recent meeting, at which many earnest experimenters had their problems solved.

A social evening has been fixed for February 7th. A special sub-committee has been appointed to deal with the arrangements for the programme, which will be a very attractive one. Competitions will be introduced and prizes will be provided for the ladies and gentlemen taking part.

A syllabus of the forthcoming meetings, which promise to be specially attractive, may be had on application to the Hon. Secretary, Mr. H. Comben, 24, Park Lane, Wembley.

**Wireless Theory Simplified.**

A recent lecturer before the Golders Green and Hendon Radio and Scientific Society was Mr. Maurice Child, who dealt in a helpful manner with H.F. amplification and selectivity. Mr. Child emphasised the importance of a knowledge of the fundamental principles of electricity, the lack of which was the cause of many amateurs' difficulties. The articles appearing in *The Wireless World* under the title "Wireless Theory Simplified" must be of the greatest value to members, said Mr. Child, and should be most carefully read and studied by all interested in wireless.

To satisfy the request for informal meetings, Mr. Zwanenberg has placed his laboratory and workshop at the disposal of members.

The Society's fourth dance will be held on January 30th. Full particulars of membership will be sent on application to the Hon. Secretary, Lt.-Col. H. A. Scarlett, D.S.O., 60, Pattison Road, Childs Hill, N.W.2.

**For South London Enthusiasts.**

"We are still going strong," is the report from the Faraday Radio Club, which holds meetings every Thursday at 7.45 p.m. at the Walworth Men's Institute, John Ruskin L.C.C. School, Beresford Street, S.E.5. Prospective members are always welcome.

Hon. Secretary, Mr. J. H. Payton, 39, Penton Place, London, S.E.17.

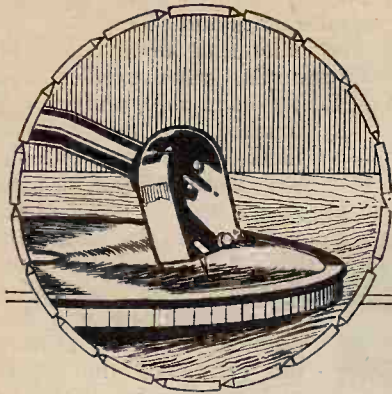

# Gramophone Needle Wear

The Reasons for Frequent Needle Changing.

By E. M. PAYNE

(Research Department, The Gramophone Co., Ltd.)

*Why do all the gramophone companies recommend the changing of the needle after every single record side has been played? Is it just another dodge to get the public to buy more needles? The answer is easily arrived at by examining the various figures in this article and considering the actual facts.*

GRAMOPHONE needles may be roughly divided into three classes:—(1) Steel (loud, medium, soft, etc.); (2) Fibre; (3) Permanent. The wear on each of these three types is of a rather different nature, but in every case the effects upon music reproduction are similar. They are (a) loss of treble notes and (b) a peculiar combined woolliness and harshness. The effects upon the records themselves are disastrous in respect of the steel needles of class (1).

First, it is necessary to correct a popular fallacy. The term "soft" as applied to gramophone needles does not mean nowadays that the steel has been tempered to a lower figure in the hardening scale and is thus more easily abraded, but it is only a reference to the intensity of musical reproduction obtained from its use, thus a "soft" needle means a *quiet* needle. In the early days the loudness of a gramophone was easily regulated by using needles of different hardness temper, hence the origin of "soft" as applied to needles. A "soft" tone needle does not necessarily wear any faster than a loud tone, in fact, sometimes the reverse occurs.

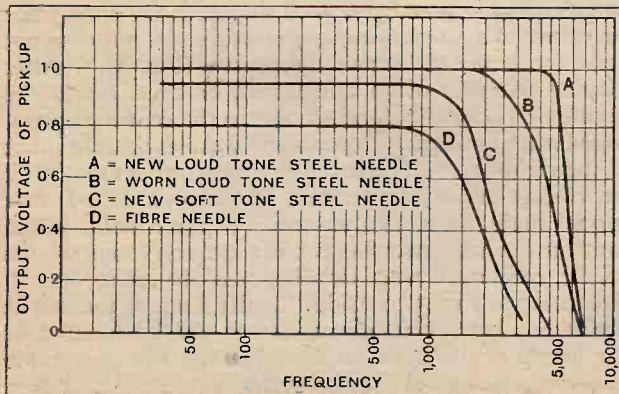

Fig. 1.—These curves reveal the behaviour of a gramophone pick-up when various types of needles are used.

An examination of Fig. 1 shows the R.M.S. voltage output actually obtained from a pick-up when playing a range of constant note records with various needle conditions. It will immediately strike the reader that

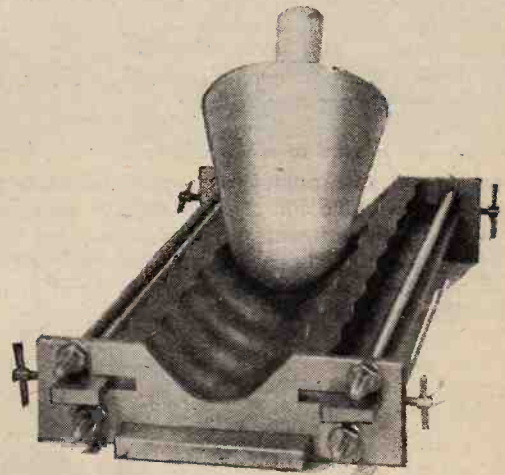

Fig. 2.—Large scale model of a steel needle moving in the groove on the record. The furrows represent a note of 4,000 cycles per second.

the principal effect of using a soft tone needle or fibre needle is to quieten the treble notes, the bass notes remaining almost as loud as when using a loud tone needle. This is a rather surprising fact. Curve B is of great interest because it shows us that the treble response is again reduced when we use a worn needle.

Why does this reduction occur? Record and needle groove models of truly gigantic proportions have been made up in order to solve this problem. Figs. 2, 4, 6 and 7 are photographs (considerably reduced in size) of the

<sup>1</sup> The photographs which accompany this article are reproduced by courtesy of The Gramophone Co., Ltd.

**Gramophone Needle Wear.**—

needle tip and groove. The scale of the model was 400 times full size, so that the complete needle would be a pointed steel cylinder, 20ft. long, weighing  $11\frac{1}{2}$  tons, and the complete record stood on end would be as tall

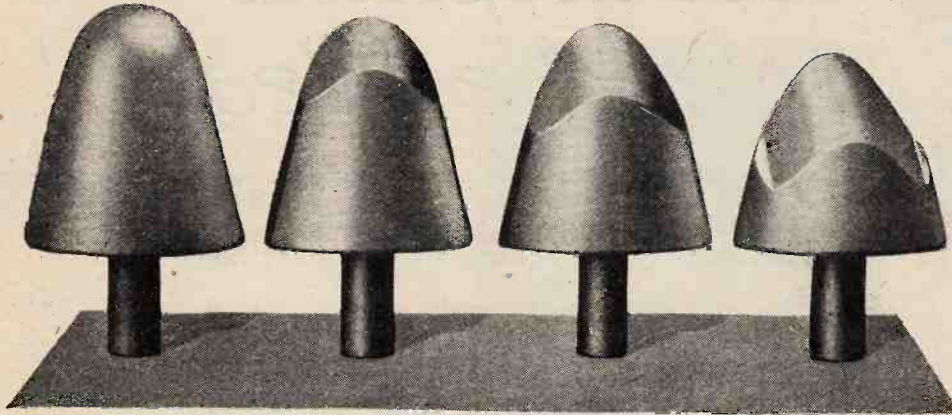

Fig. 3.—Progressive stages in the wear of a loud tone needle.

as St. Paul's Cathedral. To make the extreme tip of the needles was obviously easy, but to ensure the accurate production of the record groove cheaply was very difficult. Thousands of identically shaped laminae of very thin material were stamped out to the exact contour of the cross-section of an average record groove, and these laminae were gripped between a pair of blades in a special framework. The blades were about 18in. long, and were shaped up in pairs to various desired wave forms. The form in Fig. 2 is that of a 4,000 cycles per second sine wave.

**Effects of a Worn Needle.**

The best relative angle ( $65^{\circ}$ – $70^{\circ}$ ) between needle axis and record face for a good quality pick-up was determined by experiments upon normal sized needles, and the big scale needles were cut away on their flanks so as to reproduce the various abrasions which had been noted from microphotographs of needles worn under

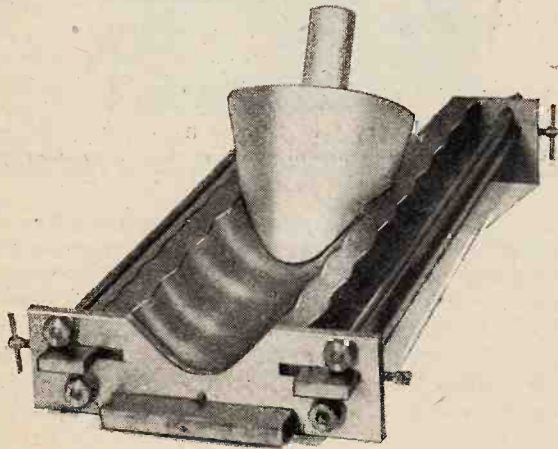

Fig. 4.—New needle the end of which has been devised to fit snugly into an 8,000 cycle groove, resting against the contours of a 4,000 cycle groove.

various conditions of playing, such as heavy and light orchestral passages, soprano notes and so on.

Incidentally, some very interesting discoveries were made in this work, for example, some needles were found to be worn off on the left-hand only, and scarcely touched on the opposite flank, while other needles were worn on the right-hand flanks only. It was afterwards found that in the first case the face of the record was not truly horizontal, and the pick-up was thus running down hill towards the centre of the record with the needle acting as a brake; while in the second case the pick-up arm back bearing had been adjusted too tightly, and thus the needle point had a very unfair load placed on one side of it. Needless to say,

the effect on the records was disastrous, and reproduction of music was "woolly" and dull towards the end of the record.

Now let us look at Fig. 3 which shows an average loud tone needle at various stages of wear. The

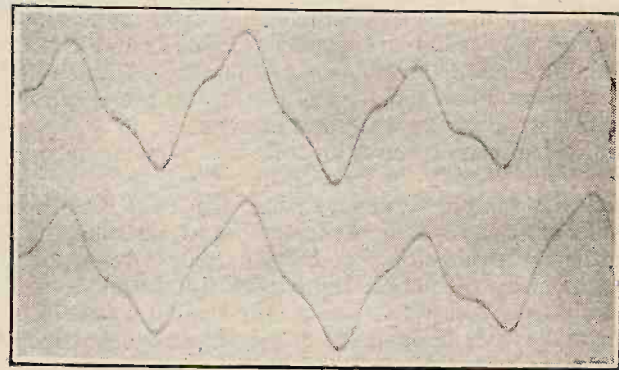

Fig. 5.—Curves showing the movement of the pick-up armature with a new needle (upper curve) and a worn needle (lower curve).

new needle has a nicely domed tip which fits snugly the curvature of a 5,000 cycles per second note, but does not quite touch the bottom of the groove (Fig. 4). After playing one side of an average 10 or 12in. record the needle tip takes up a form similar to the centre pictures, whilst after two heavy records the wear approaches that of the right-hand side view. We must, of course, work on average records in general, as it was found that special notes, such as a sustained soprano note, would cause a definite narrowing of the extreme point of the needle combined with striations on the worn flanks. Returning to Fig. 3, consider the flat flank of the needle which has been worn away, and it will be found that the length of the flat is of the same order of magnitude as the wavelength of a 4,000 cycles per second note on a record.

**Gramophone Needle Wear.—**

From actual measurements and calculation the above wavelength is around four thousandths of an inch on a two-inch radius groove, whilst the length of flat of the left-hand centre worn needle is around three thousandths of an inch. It is obviously impossible for the needle point to follow accurately the minute waves of fre-

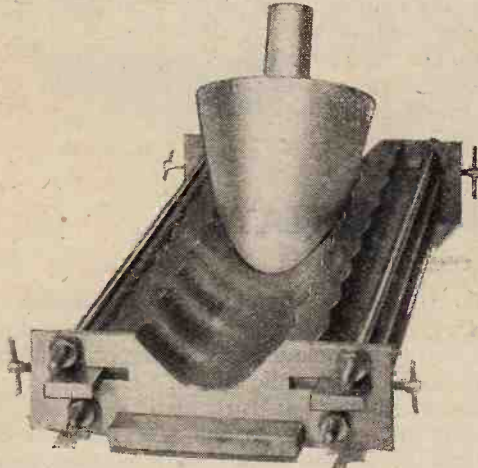

Fig. 6.—Badly worn needle riding on top of the groove walls. This gives rise to a scraping noise while the needle tip is free to wobble in the groove.

quencies above 4,000 cycles per second or so when once this flat flank has been formed by abrasion.

Here then we have, in our models, a tangible means of showing that there is a limit to the reproduction of treble notes which it is possible to obtain from a record-needle groove system. As a further check on this fact, greatly magnified traces of the angular motion of the armature spindle of a pick-up were made when playing a passage of music on a record with a new and a worn needle. These traces are shown in Fig. 5. It will be observed that there is a definite loss of the finer treble frequency "kicks" on the record. It should be remembered that top "C" of a grand piano is around 4,100 cycles per second. Now if we consider the right-hand worn needle of Fig. 3 which has two distinct flats, and also look at Fig. 6, the weight of the sound box is

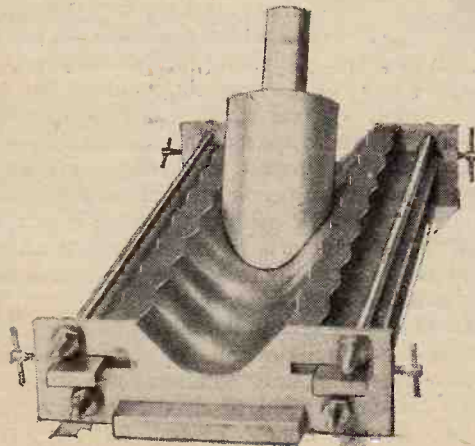

Fig. 7.—Worn Tungstyle needle where the width of the groove is greater than the diameter of the needle.

taken by these small flats which scrape along the top of the walls of the record groove. This causes a very objectionable scraping and tearing noise, while the needle tip itself is free to wobble about in the groove, being pushed over first by one side wall and then by the other. Distortion of all frequencies except the very lowest bass is caused. Thus we find that the loss of treble and the peculiar combined woolliness and harshness are definitely accounted for along quite obvious lines when we study these huge models.

Improved reproduction of treble notes can be obtained by increasing the radius of the music groove from the centre of the record; this has the effect of increasing the surface speed of the record, and hence increases the wavelength so that the flat flank of the needle is of small dimensions compared with the wavelength. This improvement unfortunately is not at present practicable. Another improvement may be made by using an exceedingly hard needle such as a diamond and shaping the point specially so as to reduce the above interference. These changes, however, are not commercially possible.



Fig. 8.—Microphotograph showing wear of record groove caused by badly worn needle.

Fibre needles are quite good for users who like to preserve their records indefinitely, but even with these it is essential that the record faces be kept clean and free from dust or grit, as the fibre picks up the grit and acts in the same way as a "lap" for cutting a diamond facet. The reproduction of treble notes when using a fibre needle is definitely poor, as is shown by curve D on Fig. 1. This is due, first, to the presence of distinct flat flanks quickly forming on the needle tip, secondly, to the very low stiffness figure which the stick of fibre possesses, and thirdly, to the quick formation of "shoulders" on the needle tip, which are rather similar to those of the much worn steel needle. The fibre should be repointed after every playing, and the point should be lowered gently into the groove always.

Fig. 7 shows the advantage of using a permanent needle such as the Tungstyle needle. The chief character of this needle is that in its extreme tip it contains a short piece of soft tungsten wire only six thousandths of an inch in diameter. Now the maximum width of groove on an average record is slightly larger than this diameter, so that no matter for how long the needle is worn away, it is impossible for "shoulders" to become worn on the needle tip, and the only distortion obtained with their use is to attenuate to a very slight degree the

**Gramophone Needle Wear.**—

treble frequencies around the high notes of the piano. Care must be taken when using these, or in fact, any needles to ensure that the pick-up is not dropped or handled clumsily when placing it on the starting grooves of a record, also it is not advisable to change the position of the permanent needle in the needle holder, as fresh flat flanks have then to be worn upon the needle tip, and the record grooves may suffer.

The flat flanks which so soon appear on steel needles act like chisel edges upon the rapidly moving record groove walls, and carve an ever-widening passage for

the needle tip in a similar manner to a bulky barge being dragged along a neglected canal (Fig. 8). Record wear, however, is a different study from needle wear, and must be treated separately, although always with very strict reference to needle wear.

This article has dealt with needle wear pure and simple, and does not take into account the differences of wear which are found when various pivot-bearing suspensions are used, or when various weights of pick-ups are used. The reaction of the needle to the groove in these cases plays a very important rôle at certain selective bands of frequencies.

**THE RADIO SITUATION IN THE STATES.**

By AN AMERICAN CORRESPONDENT.

IT may be interesting to British readers to learn how the recent financial crash in Wall Street circles has affected the American radio industry. One thing is clearly evident, namely, that although radio has been thought to have passed from the luxury to the necessity class, it was, with automobiles, almost the first trade to be affected by the financial troubles.

Just before the trouble came the bulk of the radio business was in the hands of the following makers: Radio Corporation of America, Zenith Radio of Chicago, Sparton, Atwater-Kent, Grigsby-Grunow, makers of the Majestic set and with the reputed biggest output in the States, amounting to over 6,000 sets per day, Stromberg-Carlson, and Crosley. The effect of the crash was electrical. Several companies immediately reduced their prices, notably Grigsby-Grunow, Atwater-Kent and R. C. A. Whether this panic legislation was due to the crash is known to themselves only, but rumour has it that the price reduction did none of them any good, but on the contrary hardly enhanced their reputation. Others, notably Stromberg-Carlson, actually increased prices, while Zenith immediately announced by nation-wide advertising that they were not going to reduce prices as their goods were worth every cent that was asked for them. The fact remains that several of the above-mentioned manufacturers with an output running into literally thousands of sets per day had to close down entirely, and that in the very busiest part of the radio season. Others, however, have carried on at a reduced scale.

One well-known company, Earl Radio, which incorporates Fried-Eisemann and Freshman, is now in the hands of a receiver, but it is said that it will probably be reconstructed on a fresh basis.

A significant fact is the entry of that gigantic automobile trust, General Motors, into radio by the launching

of a radio subsidiary company in conjunction with R.C.A. Dayfan Radio has also been bought up and others are said to be included in the merger. The result will be the provision of radio sets in automobiles in the General Motors range at an early date.

Everything here points to the fact that the radio industry will be in the hands of a smaller number of firms before long, just as the motor industry is mainly in the hands of General Motors, Ford, Chrysler, Packard and one or two more.

Another interesting rumour is to the effect that a set has been evolved without the use of valves, and that it has been thought to be so dangerous to the valve groups here that the inventor has been persuaded to take a large sum of money and his invention put on the shelf. This rumour is, however, not taken very seriously here.

Considerable interest is still being shown in television in theory, but no manufacturer yet has dared to put out a television set. Enquiries among many of them elicit the fact that they still consider television to be an interesting scientific toy, but not having yet reached the practical stage. At the same time, a

noted maker of radio parts and accessories—Carter Radio Co.—is said to propose marketing television parts this season and to have predicted that television will be commercially practicable within a year. It is not believed that this statement is based on the use of any of the present television systems. The same company is preparing to market a home talkie.

Rumours of mergers are in the air continually, it being recognised that in the States the day of the small manufacturer has gone, and only combination can meet the pressure of the competition of the big groups. Home construction, having almost ceased for some years, appears to have suddenly revived, but it may only be a spasmodic attempt and not a serious revival.

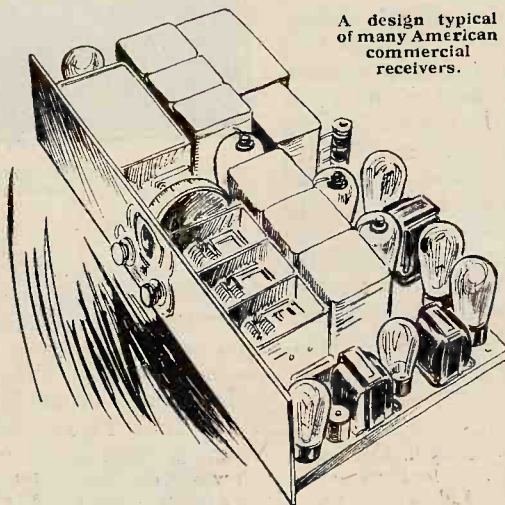

A design typical of many American commercial receivers.

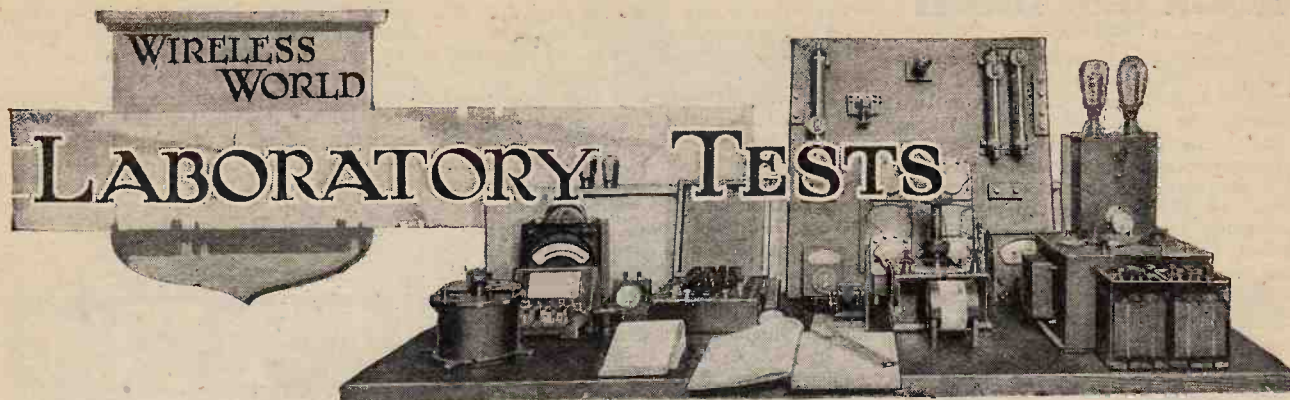

A Review of Manufacturers' Recent Products.

**PRECISION UNIVERSAL D.C. TEST SET.**

This test set has been developed by the Central Manufacturing Company, Crown Works, Birmingham Road, Walsall, for the purpose of measuring the D.C. currents and voltages generally met with in ordinary electrical test work. The nucleus of the set consists of three high-grade moving coil instruments reading 0.05 amp., 0.1 volt, and 0.25 mA., the first being the left-hand meter and the others following in the order mentioned.



Precision Universal D.C. test set with shunts and series resistance for the voltmeter, in position.

Multipliers, in the form of shunts for the current meters and series resistances for the voltmeter, are available to extend the range in each case. The set is, therefore, admirably suited to deal with the currents and voltages ordinarily encountered in wireless test and experimental work.

One advantage of separate meters is that simultaneous observations can be made of the currents and voltage in different parts of a circuit or receiver. This is not possible with a single-scale multi-range instrument.

The makers claim that these instruments are accurate to within plus or minus 1 per cent., but in view of the rather short scale and taking into consideration the thickness of the pointer we believe that, under normal conditions, a greater accuracy than 5 per cent. cannot

be expected on the lower parts of the scale, but it is just possible to read within 1.5 per cent. on the upper portion. Tests made with standard laboratory instruments showed that, without multipliers, the maximum error did not exceed 2.5 per cent. This was recorded on the lower range of the voltmeter, and decreased as the voltage was raised. The milliammeter exhibited the same characteristic, but in this case the greatest error was 2 per cent. only. The ammeter showed its greatest error at full scale, viz., 1.6 per cent., and this decreased towards the lower end.

The same high order of accuracy was not maintained when the shunts and series resistances were fitted, in some cases an error as high as -8 per cent. being recorded. At most parts of the scales the average error was of the order of 4 per cent.

The price of the test set without multipliers is £5 5s. Shunts cost from 7s. 6d. to 15s., and voltmeter resistances from 7s. 6d. to 39s.

o o o o

**MODIFICATION TO MULLARD RECTIFYING VALVES.**

The increasing popularity of super-power output valves demanding a relatively heavy anode current has induced the Mullard Wireless Service Co., Ltd., Mullard House, Charing Cross Road, London, W.C.2, to redesign the DU.2 and DU.10 rectifying valves. Hitherto the maximum output was 40 milliamps., and to meet the present demand this has now been raised to 75 mA. for the full- and half-wave models. The filament voltage and current remain the same, viz., 4 volts at 1.1 amp. The price is unchanged; 20s. for the DU.2 (full-wave) and 15s. for the DU.10 (half-wave).

o o o o

**DUBILIER WAVE-TRAP.  
Type BRI.**

This unit has been designed especially for use in the London area, its function being to reduce interference from the

358-metre regional transmitter and enable alternative programmes to be received on a set not sufficiently selective to achieve this under present conditions. It consists of an absorption rejector circuit which is connected between the aerial lead and the set, no alteration to the receiver being required.

A practical test was made using a simple receiver which normally would not separate the transmission from 2LO and 5GB within eight miles of Brookmans



Dubilier anti-interference unit Type BRI, an absorption rejector designed to reduce interference from 2LO.

Park. With the rejector connected interference from the local station was restricted to a narrow band of from 340 to 370 metres, and below and above these two limits signals from various sources could be tuned in without a whisper of interference from 2LO.

The rejector is housed in a neat case moulded in bakelite, the terminals and condenser adjustment being protected by a circular cover. It is supplied adjusted to reject the 358-metre transmission, but a small correction will probably be found necessary owing to the effect of aerial capacity on the tuning of the rejector circuit. An adjusting screw, with a small slot for insertion of a screwdriver, is provided for this purpose.

The makers are the Dubilier Condenser Co. (1925), Ltd., Ducon Works, Victoria Road, North Acton, London, W.3, and the price has been fixed at 15s. 6d.

### BURNDIPT NEEDLE ARMATURE PICK-UP.

In designing a gramophone pick-up the principal difficulties are associated with mechanical resonances in the vibrating system. As explained in a recent article,<sup>1</sup> the most satisfactory way of overcoming these difficulties is to reduce to a minimum the inertia of the armature. In the latest Burndipt pick-up this policy is carried to its logical conclusion; the needle itself forms the armature, and the vibrating mass is consequently brought down to the irreducible minimum. Actually, there is a



Burndipt pick-up and tone arm.

small boss N embedded in rubber which acts as the needle-holder, but as the axis of motion passes through the centre of the mass the moment of inertia about the axis is small. The needle-holder is of square section and fits, with its rubber packing, into a parallel-sided slot in the needle housing H, so that the movement of the needle is controlled and so prevented from falling on the pole pieces P. The latter are attached to the pick-up coil former C, through the centre of which passes the needle armature. The permanent magnet is of generous cross-section and is insulated acoustically from the metal shell by a rubber packing strip and washers R.

The pick-up unit is mounted on the curved tone arm at a predetermined angle which gives a maximum tracking

<sup>1</sup> "Gramophone Pick-Ups," *The Wireless World*, October 30th, 1929, page 483.

error of not more than  $2\frac{1}{2}$  degrees. A swivel joint enables the pick-up to be inverted for inserting or withdrawing the needle.

The characteristic of the specimen submitted for test is given below, and it will be seen that the output is remarkably constant from 50 to 4,500 cycles. Between 4,500 and 6,000 cycles there is an irregular increase which is useful in giving brilliance and timbre to the higher fundamental frequencies used in music. At the other end of the scale the output rises from 50 cycles downwards. In practice this may be ignored as the lowest frequency at present recorded is 50 cycles. A more definite rise in the characteristic from 250 cycles downwards would be an advantage, and this was actually obtained in the specimen tested by using an H.M.V. extra loud Tungstyle needle. Some difficulty is experienced, however, in fitting this needle, and for general use the Columbia De Luxe needle is recommended.

Apart from the unprecedented uniformity of the output, the most striking feature of the performance of this pick-up is the absence of any sign of record wear. While the average pick-up commences to chatter and jump the groove at about 100 cycles on the standard frequency records (in which the amplitude at low frequencies is, of course, much greater in an ordinary record), the Burndipt needle armature pick-up follows the groove with perfect silence down to 25.5 cycles the lowest frequency recorded. At this frequency the double amplitude (total width) of the groove is no less than  $\frac{3}{8}$  in.

The increased response in the region of 5,000-6,000 cycles provides the harmonics necessary to impart characteristic timbre to fundamental frequencies below 3,000 cycles, and when listening to orchestral records it is possible to distinguish between instruments even when played near their upper limit of frequency. The reproduction of transients is also very good, and such effects as cymbals and bells are unusually well reproduced.

The general level of voltage output is considerably below the average and the usual two-stage amplifier does not give sufficient magnification for normal loud

speaker volume. In general a three-stage amplifier with volume control is recommended. A 10,000-ohm potentiometer is specified by the makers, and the pick-up was shunted by a resistance of this value when taking the characteristic. An appreciable reduction of high frequencies

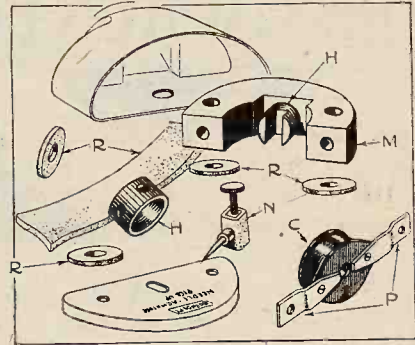

Component parts of the Burndipt needle armature pick-up.

results from the use of this comparatively low resistance. The high-frequency response of the Burndipt pick-up, however, is such that without it surface scratch would obtrude. In arriving at a value of 10,000 ohms a satisfactory compromise has been effected between these conflicting factors.

### TRADE NOTE.

Messrs. James McQueen, Ltd., Moab Road, Leicester, have forwarded us a specimen copy of their "Kwik-an-Eeze" Account-Book, which should prove invaluable to the small trader whose business does not warrant a staff of book-keepers or an elaborate system of book-keeping.

The book comprises 52 pages for analysing the various receipts and payments, and a "Private Ledger," with pages ruled for summarising the weekly totals and with skeleton trading accounts and balance-sheet in which the correct position for the various summarised totals is clearly shown. A detachable sheet is provided for a certified copy of the year's profit and loss account, and much useful information is given in the supplementary notes. The price is 4s. 6d.

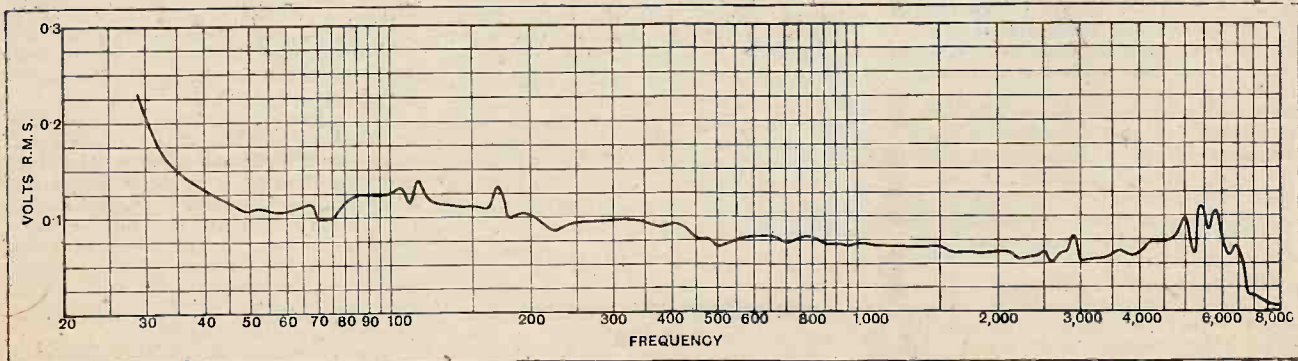

Output characteristic of the Burndipt needle armature pick-up taken with Columbia De Luxe needle and 10,000 ohms shunt resistance.

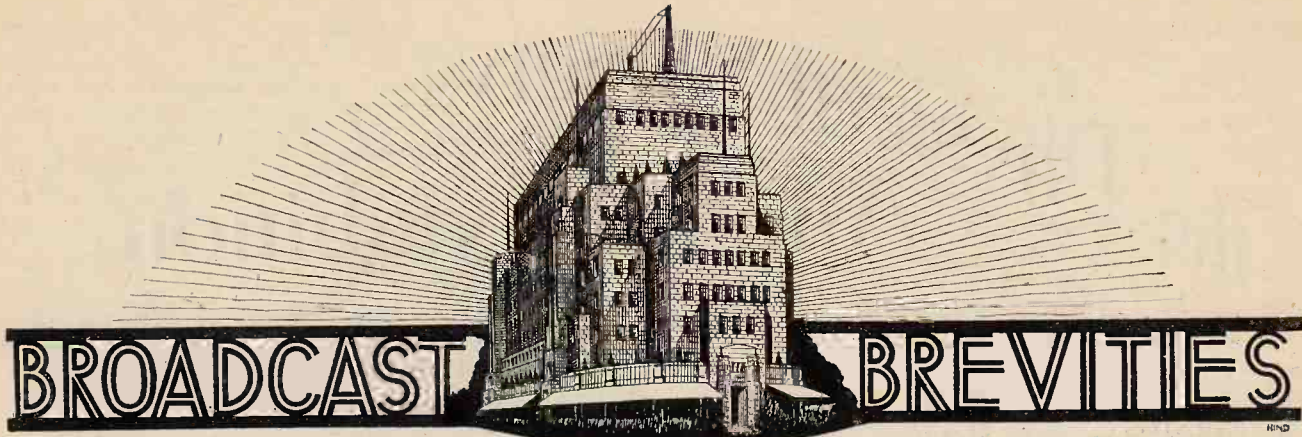

By Our Special Correspondent.

**Trouble with the Post Office.—B.B.C. and Foreign Listeners.—Radio Week Surprise.**

**The Height of Tactlessness.**

Radio Week—the one week in the year when the Post Office detector van might have been veiled in decent obscurity—was chosen for a special “war” against the wireless pirates of Manchester.

o o o o

**Nature and the Land-line Listener.**

All is not well between the Post Office and the B.B.C. This time Nature herself has upset the apple cart, and many listeners will rise up and call her blessed. The trouble has arisen over the recent gale which wrecked the overhead lines between London and Daventry.

o o o o

**It's an Ill Wind . . .**

The catastrophe has suddenly caused Savoy Hill to reflect that there are such things as underground cables, and the question is being asked: Why can't the Post Office emulate the German Postal Administration by giving broadcasting the best form of line available, i.e., underground? Experience in Germany, as revealed by the recent Cologne relays, has shown that a well-shielded underground cable gives far better results than an overhead line.

o o o o

**Weather Permitting.**

At present the only underground cable used by the B.B.C. is the short stretch between Savoy Hill and Brookmans Park. The results on this line are nearly perfect, as the fortunate listeners who can tune in direct are ready to testify, but this is small consolation to the vast majority who have to rely on the network of exposed wires which carry the mangled remains from Land's End to John o' Groat's.

In view of the gale experience the B.B.C. is thinking of announcing programmes with the proviso “weather permitting.”

o o o o

**The Swing of the Pendulum.**

Not long ago it seemed as if the pessimistic advice from certain quarters was taking effect, and that listeners were abandoning the glories of the chase for distant stations in order to concentrate

on local reception. Happily this parish pump attitude is losing what prestige it ever possessed. Listeners are reaching out and are finding that the Prague Plan, with all its failings, still enables one to obtain real pleasure from Continental programmes.

o o o o

**Support for the B.B.C.**

A B.B.C. official tells me that many foreign listeners are concentrating on the reception of Brookmans Park. Apparently the Corporation need not worry too much over complaints from British listeners, as it can always count on staunch supporters in Poland and Czechoslovakia.

o o o o

**Radio Week Surprise.**

“Every Week is National Radio Week” is a newly suggested slogan for the B.B.C., arising out of the exciting discovery that this week's programmes are even better than those of last week. The B.B.C. has done well to realise the futility of enticing new listeners with a programme standard which was not to be maintained.

**More Stunts Required.**

At the same time, I think that during Radio Week the Programme Department might have relaxed their apparently iron rule to avoid “stunts.” An occasional stimulant is good for the system. More recruits would have been enrolled if the programmes had been invested with a continuity interest. A problem could have been propounded on Monday, growing increasingly complicated from night to night, until the final unravelling on Saturday. There is still time to develop such an idea before the winter is out.

o o o o

**The Plea of a Mortician.**

Queer requests blow into Savoy Hill at times, but I am glad to think that nobody in this country has gone so far as Mr. John S. Martin, of New Jersey, described as a “mortician,” who asks the U.S. broadcasting authorities to set aside a fixed hour daily for the nationwide broadcasting of funeral music.

o o o o

**Discouraging the Individual.**

Four years ago the old B.B. Company obliged a young couple by broadcasting Mendelssohn's Wedding March, but the present Corporation refuses to encourage the individual at the expense of the multitude. It would certainly concede nothing to Mr. John S. Martin.

o o o o

**Broadcasting House.**

One more stage is reached in the progress of Broadcasting House by the signing of the building contract between the owning syndicate and Messrs. Ford and Walton, Ltd. The erection of the superstructure is to begin early next month when the spade work below street level is completed.

o o o o

**G.B.S. at the Microphone.**

Mr. G. Bernard Shaw's speech at a public meeting at the Kingsway Hall, London, convened for January 31 by the British Drama League in support of the National Theatre, will be relayed to 5GB.

**FUTURE FEATURES.**

**London and Daventry (5XX).**

JANUARY 26TH.—Service relayed from Chester Cathedral.

JANUARY 29TH.—“La Bohème,” an opera by Puccini.

JANUARY 30TH.—“Huntingtower; or, The Adventurous Holiday of Mr. Dickson McCunn,” John Buchan's novel adapted for broadcasting.

FEBRUARY 1ST.—Running Commentary on the International Rugby Football Match, Scotland v. Wales.

**Daventry Experimental (5GB).**

JANUARY 27TH.—“La Bohème.”

JANUARY 28TH.—Liverpool Philharmonic Society Concert relayed from the Philharmonic Hall, Liverpool.

**Manchester.**

JANUARY 28TH.—Liverpool Philharmonic Society Concert, relayed from Philharmonic Hall, Liverpool.

**Glasgow.**

JANUARY 28TH.—“What's Right With Scotland?” a revue.

JANUARY 30TH.—“Huntingtower.”

**Belfast.**

FEBRUARY 1ST.—“Baghdad on the Subway,” a New York Phantasmagoria.



# The Physical Society's Annual Exhibition

Features of Interest to the Wireless Experimenter.

**A**PPARATUS of interest to wireless students always occupies an honoured place at the Annual Exhibition of the Physical and Optical Societies, and this year's event, held at the Imperial College of Science and Technology on January 7th, 8th, and 9th, was no exception to the rule.

In the Research and Experimental section of the Exhibition the exhibit of the National Physical Laboratory (Wireless Division) aroused considerable interest,

much attention being paid to an automatic recorder of bearings from a rotating beacon transmitter, similar to that now in operation at Orfordness. The bearings are recorded on a circular drum, which is rotated synchronously with the transmitter by means of a phonic motor and tuning fork.

Of more immediate interest to the experimenter was the N.P.L. apparatus for the measurement of the overall performance of radio receivers. A radio frequency oscillator, operating a wide range of frequencies, is used for the supply of small input voltages on the receiver under test. The R.F. oscillations are modulated to any desired degree with the aid of a separate audio-frequency source. The current output from these generators is passed through a resistance of special design, and a suitable tapping point is provided in order that a known radio-frequency potential difference may be applied to the input terminals of the receiver under test. The audio-frequency output from the receiver is then measured with the aid of a valve voltmeter connected across a small resistance in series with the output or loud speaker load. In the N.P.L. exhibit the oscillators were contained in a metallicly shielded cabin, and the receiver in a separate room screened with wire netting.

The study of acoustics is becoming more and more necessary to radio research workers, and in this connection the research laboratories of the Gramophone Co., Ltd., and the Marconiphone Co., Ltd., exhibited several models of unusual interest. One of these, showing a rapid visual method of measuring reverberation in a hall, included a loud speaker, which, after setting up a steady sound at a given frequency, is switched off. The sound of the reverberation in the hall is picked up by a microphone

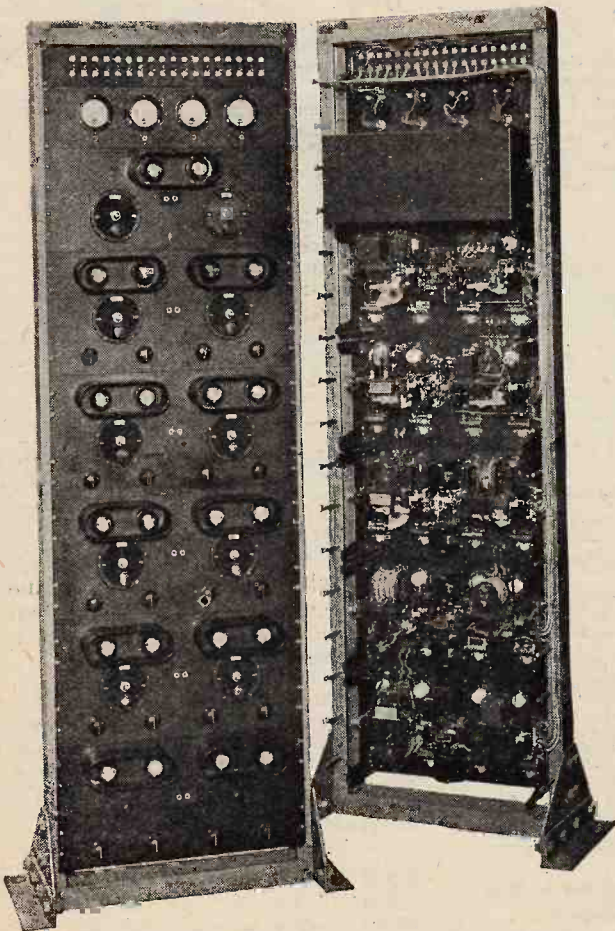

Front and back views of the frequency doubling circuit panel for the Marconi tuning fork drive. This system is employed by all the B.B.C. relay stations.



The "Kerr" cell shown by Messrs. Isenthal and Co., Ltd. This device is complementary to the ordinary photo-electric cell, its use being to reconvert electric impulses into variations of light density.

**The Physical Society's Annual Exhibition.—**

and recorded on a cathode ray oscillograph with linear time base, so that the dying away effect can be observed and a visual estimate made of the time.

Another fascinating exhibit was a model of a photographic sound-recording system, comprising a glow

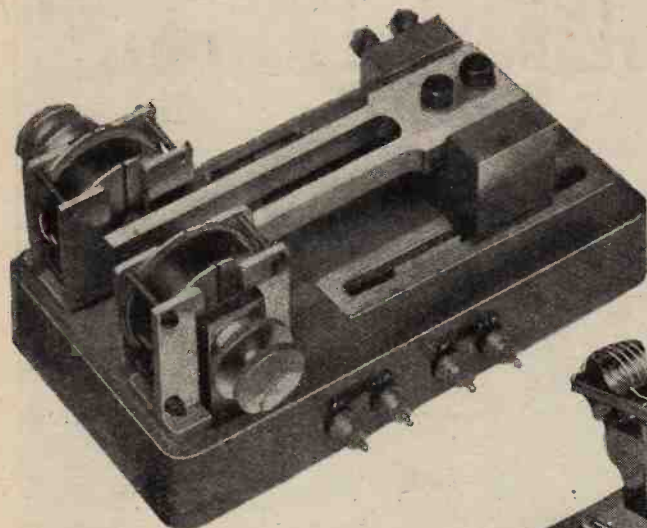

The Marconi tuning fork used in the frequency control of radio transmitters.

lamp, the brilliance of which is modulated by speech current from a pick-up. A slit of light after traversing an optical system impinges on the film and makes a record of the variable density type.

Elsewhere in this issue is an article describing a demonstration of the methods employed for reproducing physically the conditions in a gramophone record groove and of examining the behaviour of different types of needles.

The two companies also showed a filament-maintained mercury vapour tube in which the conductivity can be greatly increased when a magnetic field is applied in a direction parallel to the filament. Over a certain range this increase is proportional to the strength of the magnetic field, and can, therefore, be continuously varied by means of a permanent magnet which, for example, can be suspended from a pendulum.

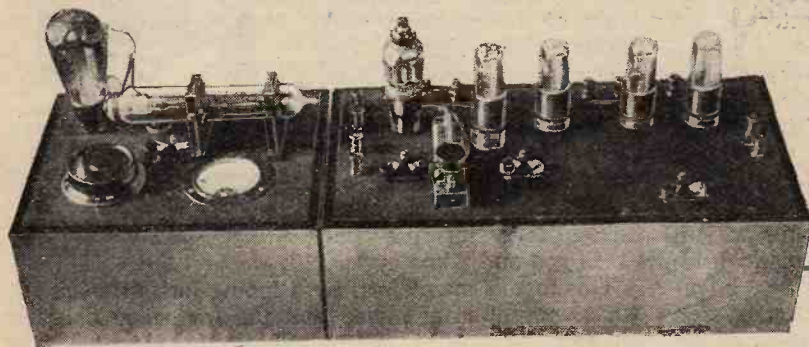

The new Lucas-Sullivan quartz frequency standardising apparatus (H. W. Sullivan, Ltd.), for frequencies between 50 and 3,000 k.c.

Mr. E. B. Moullin exhibited a new form of small-capacity variable condenser, suitable for precision measurements at very high frequencies, and an absorption wavemeter for use on short waves. A new directional short-wave transmitter operating on wavelengths between 6.04 and 8.65 metres was shown by Messrs. L. S. Palmer and L. L. Honeyball.

**A New Loud Speaker Demonstration.**

An interesting acoustic exhibit was that of Capt. B. S. Cohen and Mr. Robt. W. Paul. This was a new moving-coil loud speaker using pistons of Balsa wood, which combines an extremely low density with considerable elasticity.

The measurement of sound pressure was demonstrated by the research laboratories of the General Electric Co., Ltd., employing a condenser, transmitter, and amplifying system for dealing with frequencies from

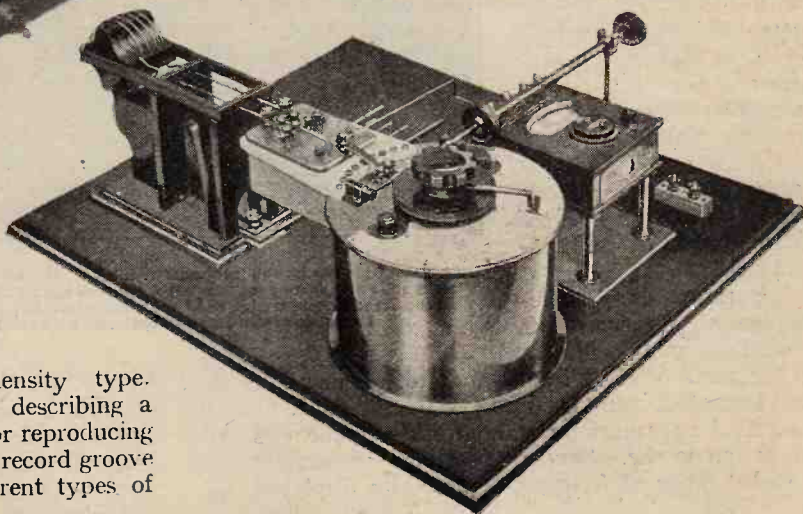

A short-wave precision sub-standard wavemeter exhibited by Messrs. H. W. Sullivan, Ltd. The wavelength range is from 5 to 100 metres.

50 to 5,000 cycles per second. The Mercury Vapour Triode Thyration is the term applied to an interesting exhibit of the British Thomson-Houston Co., Ltd., showing the principle of grid control applied to a hot-cathode mercury vapour rectifier. With a given potential applied between the anode and cathode no current flows providing that the grid potential exceeds a critical value. Once the anode current is started, however, the grid loses all control due to the presence of ionised vapour, and to stop the anode current the circuit must be opened, if on D.C. supply. When A.C. voltage is used, the current stops at the zero of the cycle.

As might be expected, the Exhibition dealt generously with electrical measuring instruments. Many of the smaller instruments were of really practical interest to the amateur. A new galvanometer (of 2 mA. and 80 mV. full scale)

**The Physical Society's Annual Exhibition.**— of considerable laboratory utility was shown in the trade section by Crompton Parkinson, Ltd. One pattern has even scale divisions, while the other has uneven divisions with wide calibration about zero.

Wireless workers are always attracted to the display of the Weston Electrical Instrument Co., Ltd. New features this year included a new multi-range D.C. testing set and a "valve checker" for testing any A.C. or D.C. valves having filament voltages of from 1.5 to 7.5 volts. The Cambridge Instrument Co., Ltd., also presented their wide range of laboratory apparatus, one of the most interesting items being the new Campbell Standard Mutual Inductometer, which has a wide range for the direct measurement of self-inductance.

Apparatus for radio-frequency measurements was the main feature on the stand of H. W. Sullivan, Ltd. A new item was the Lucas-Sullivan Quartz-Crystal Standard and its associated apparatus for standardising frequencies from 50 to 3,000 kc. Several precision wavemeters for a varied range of frequencies were also displayed.

The thermionic valve, always the darling of the research engineer, was well represented. The exhibit of the M.O. Valve Co., Ltd., included valves for every purpose, from modest 2-volt detectors to the high-power cooled-anode transmitting types as used at G.P.O. and B.B.C. stations. An automatic grid-making machine was seen

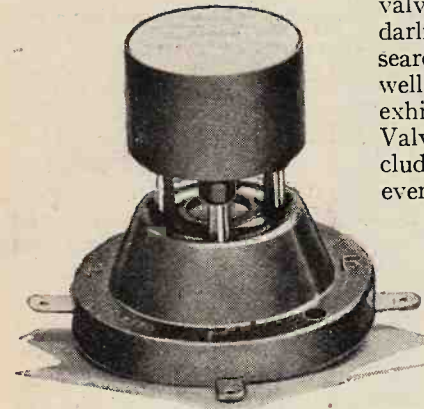

A new vacuo-junction device by the Cambridge Instrument Co., Ltd., in which the thermo-junction and the heater are enclosed in a highly exhausted glass bulb to eliminate air current effects.

in action. Valves of all kinds were also displayed by the Mullard Wireless Service Co., Ltd., who showed in addition a working model demonstrating the opera-

tion of a low-frequency amplifier. A complete range of rectifiers was shown, ranging from 30 mA./250 v. to 2 amps./12,000 v. An extensive range of transmitting and receiving valves was also exhibited

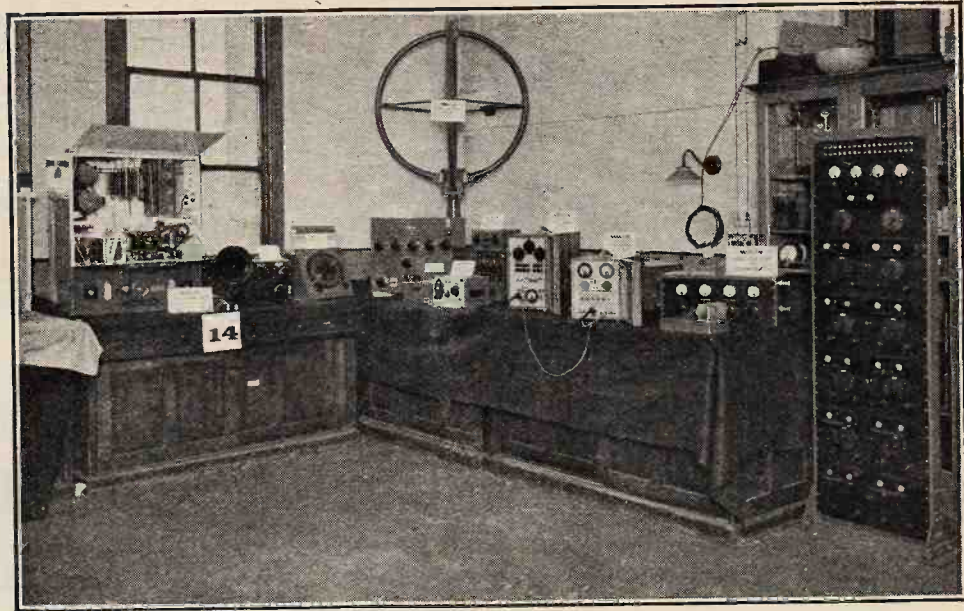

A general view of the Marconi exhibit. On the extreme left is a telephone set for ships, and next to it a marine receiver with a wavelength range of from 15 to 20,000 metres. In the corner is the fixed frame aerial used with the direction-finder seen on the right of the left-hand bench. Portable testing equipment can be seen in the centre of the right-hand bench.

by the Ediswan Co., whose stand included the products of their associated concerns, the Metropolitan Vickers and B.T.-H. companies. These included loud speakers, gramophone pick-ups, microphones, and several different eliminators.

The variety of exhibits on the stand of the Marconi Company gave it a special attraction. One exhibit was an aircraft direction-finder with a streamline frame aerial designed to enable the loops to be supported in a rigid position as far as convenient from the body of the machine with minimum air resistance. The ever-growing necessity of maintaining the frequency of broadcasting stations at a constant pitch lent special interest to the exhibit of a thermostatically controlled tuning fork for use between 700 and 1,400 cycles.

This fork is maintained by a tuning fork drive circuit whose output is amplified and the frequency doubled ten times by a series of push-pull selecting circuits. This form of control is used at the B.B.C. relay stations. Among many other exhibits was a telephony set for

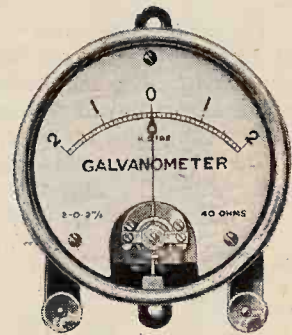

A useful laboratory instrument. A new moving-coil calibrated pointer galvanometer, shown by Messrs. Crompton Parkinson, Ltd., with centre zero and giving full scale deflection at 2 mA. and 80 mV.

**The Physical Society's Annual Exhibition.—**

use by unskilled operators. Designed specially for service on trawlers, lightships, etc., this transmitter will operate on 600 metres and on any fixed wavelength between the limits of 150 and 400 metres.

Other stands dealing largely with wireless apparatus were those of the Telegraph Condenser Co., Ltd. (new-comers to the Exhibition), showing a comprehensive range of condensers for wireless reception and transmission purposes; Bakelite, Ltd., whose products were shown in a bewildering variety of mouldings, rods, insulating varnishes, etc.; the Fuller Accumulator Co.,

Ltd., displaying a profusion of L.T. and H.T. batteries in all shapes and sizes; the Zenith Electric Co., Ltd., specialising in resistances; Isenthal and Co., Ltd., who displayed, among other items, photo-electric cells, Kerr cells, and glow relays; the M-L Magneto Syndicate, who exhibited for the first time a D.C. to A.C. rotary transformer specially designed for operating A.C. mains receivers from a D.C. supply; and Gambrell Bros., Ltd., who featured mains sets and the Gambrell Novotone Compensator (Dr. N. W. McLachlan's patent) for improving gramophone reproduction at extreme frequencies.

## CORRESPONDENCE.

The Editor does not hold himself responsible for the opinions of his correspondents.

Correspondence should be addressed to the Editor, "The Wireless World," Dorset House, Tudor Street, E.C.4, and must be accompanied by the writer's name and address.

**OUTSIDE BROADCASTS.**

Sir,—At 8 p.m. onwards on Sunday we listeners should demand and see that we get the best programme from the studio. It should be possible for the B.B.C. to broadcast a programme (real music, real singers, real modulation, no talking or intervals until 10.30 p.m.) to gladden the hearts of an Empire. There are over three million B.B.C. supporters paying for programmes, so why should we put up with second-hand rubbish? It is useless constructing palatial premises with fine studios when the programmes on the principal days of the week when most people have time to listen are all relayed.

London, S.W.6.

"FRAME AERIAL."

**RECEPTION OF CONTINENTAL STATIONS.**

Sir,—I have been interested in the very controversial views expressed by your correspondents recently on the above.

It seems to me the sceptics who deny the possibility of decent Continental reception fail altogether to take a broad enough view of the matter.

Primarily a favourable locality is the first necessity, and localities differ enormously—hereabouts I'd say it was good; in other parts of the country I've found it vary to definitely bad.

As a second consideration I'd place the question of the set, and here I would like to endorse heartily Mr. J. H. Borrill's remarks on the "Kilo-Mag Four." I'm in agreement with him on every point—and this after six years of experimenting with nearly every sort of set both of your publication and other journals.

I would say that this circuit sets a standard for efficient reception and reproduction of both home and Continental transmissions if properly supplied and controlled.

My last point is this: Why so much ink scattered, even if one can't hear Warsaw or Rome as perfectly as 5GB at 50 miles range? Surely one does not expect to hear and see the opera as well "up in the gods" as when favourably situated in the stalls; neither does one get the same feeling of being "in" the football match when it's viewed from the outside fringe of the crowd instead of the front row of the grand stand; but there's no need or tendency to debate this point—we've got used to accepting it in its right perspective; why not do the same with Continental reception and enjoy as much of it as circumstances allow?

Sc. B.

Wakefield.

Sir,—The somewhat heated discussion on foreign station reception prompts me to support the views held by Mr. A. W. Scott.

His rather "more forcible than accurate" statements are borne out in practice, as a really unbiased criticism of almost any evening's ether-searching will show.

A real "programme" entertainment is rarely obtainable on the broadcast band below about 300 metres, those stations

receivable at good strength being accompanied by a medley of splutters, burbles and whistles, to say nothing of periodic fading.

Above 2ZY the ether is comparatively clear, and good reception is possible from some half dozen stations, including 5GB, but the frequent occurrence of talks, etc., together with the long waits between items, deter one from listening.

In case correspondents with the "distance itch" should tell me to make a "family set," I would state that the "family set" is a S.G., Det. and L.F., using Cosmos A.C. valves, anode bend detection and no reaction.

With this combination I could, on summer nights, when interference was less pronounced, put on the speaker about three dozen stations at comfortable strength, and the selectivity is sufficient to separate 2LO, Hamburg and sometimes Toulouse within five miles of 2ZY.

A. C. WILDSMITH.

Manchester.

**THE RECORD III.**

Sir,—Particulars of a modification which I have made in my "Record III" receiver may be of interest to readers.

My output valve is a pentode and was, of course, much overloaded when the detector was working most efficiently. To correct this it was necessary to set the variable resistance across the transformer primary in almost its minimum position, which made the reproduction rather harsh and shrill. Desiring to retain the pentode as being the most convenient power valve for a moving coil loud speaker, I evolved the following circuit:—

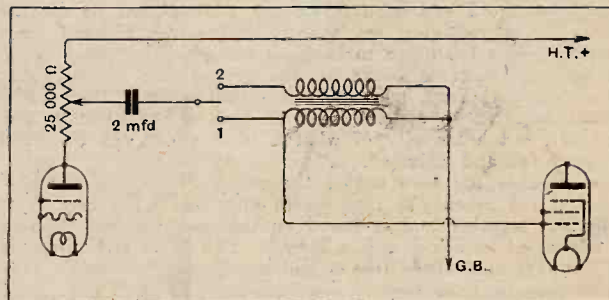

Switch in position (1) gives resistance coupling. As the resistance is only 25,000 ohms the output from the detector does not overload the pentode and no further volume control is needed. The high inductance of the transformer secondary is used instead of a grid leak. This coupling is used for the more powerful stations.

Position (2) gives parallel feed coupling. In both cases the anode potentiometer may be used as a volume control when necessary.

Sheffield.

H. HOW.

**SHOULD MANUFACTURERS CONTRIBUTE TOWARDS PROGRAMMES?**

Sir,—Most certainly they should.

Your only reason for stating they should not is that in your opinion the price of receivers would be increased.

If the manufacturers did contribute we should undoubtedly obtain better programmes, with better talent, which the B.B.C. cannot at present afford. The B.B.C. would have more money to spare for station erection, including an Empire service which we could feel was adequate.

But the most important effect would be a doubling of the listening public, leading to genuine mass production by our manufacturers, and definitely cheaper and more efficient receivers for the public.

Our programme service has time and again been compared with the American service by English writers, but have any of your readers read any reliable criticism of our service by American writers? I have, and in several instances it has been described as inadequate and puny.

Compare our licence statistics with those of America; there are half the receivers per head of population here.

My qualifications for writing this letter: I have been in the radio trade for six years and have made a special study of our own broadcasting service and those of other countries, and I am firmly convinced that unless more money than that accruing from licence fees is made available for the use of the B.B.C. our radio industry will never be in the same position as those of other countries, to the serious detriment of our export trade.

Gt. Yarmouth.

S. WEST.

**IN SEARCH OF QUALITY.**

Sir,—It is a painful business when one's idols are shattered, and so with sadness I read Mr. Bertram Munn's disturbing article in your recent issue.

So the great Mr. Munn uses nothing more convincing than a trumpet, and does not even tell us that he at least actuates the diaphragm with a moving-coil unit. Really, sir, he will next be confessing that his receiver is a simple affair with a leaky grid detector (with, of course, just a touch of reaction to ginger up the selectivity) and a brace of transformer-coupled L.F. stages. He will doubtless conclude by cheerfully admitting that his output is devoid of a filter-choke circuit, and that he does not believe in such abominations.

And now, sir, may I as a moving-coil enthusiast take up the challenge—but let me add that for my part the conflict will not be the gruesome affair anticipated by Mr. Munn; I would not shoot my great-grandfather, old-fashioned though he be, so why should I harm the venerable hairs of Mr. Munn (for, of course, he rejoices in the possession of a long, flowing white beard).

First, may I ask if Mr. Munn has carefully examined the receivers coupled to the moving-coil speakers to which he takes exception, because long before I made up my moving-coil unit two years ago I had been repeatedly warned that no speaker shows up a receiving set so ruthlessly—and I have since confirmed this too often to be good for sellers of these units. If his experience is based on the groans and boomy thuds which emanate from most "demonstration sets," then am I almost tempted to sympathise with him. Such results are, however, but a travesty of what a moving coil can do when properly fed and adjusted.

As regards my own outfit, the receiver is quite straightforward and consists of four valves only, but it has been carefully put together and is based on the best wireless practice as advocated in *The Wireless World*. The single H.F. stage is an ordinary neutralised triode, and the detector a diode. This latter feature I consider indispensable. The first L.F. is a medium power valve, and is coupled via a first-class transformer to the output—a single P.X.650 working under its maximum conditions. The transformer primary is isolated from the H.T. fed to the first L.F. valve, and the output to the speaker is via a heavy-duty choke and filter circuit. All stages are, of course, carefully decoupled. The loud speaker was assembled from standard parts and the coil itself specially wound to suit the impedance of the output valve. (I must thank *The Wireless World* for help in such technical matters.) The pot is wound for twelve volts one amp., but is frequently fed with eighteen volts.

Mr. Munn will please note that I do not use batteries of L.S.5 valves, and that my H.T. maximum is of the order of 250 volts; but I can assure him that the one watt, or thereabouts, of undistorted power at my service gives loud speaker reception of the highest quality and, I am prepared to assert, superior to anything he can do with his trumpet. Transients such as the clash of cymbals are amazingly good; a violin sounds like a violin and not like a piccolo; and even the much-maligned studio piano is pleasing. Ah! but I can hear Mr. Munn scratching away with his quill pen: "What about the announcer's voice?" Alas! I must admit that, when the set is adjusted correctly for a musical item, it is too loud. It does not, however, boom at one through a tunnel lined with cotton wool as Mr. Munn would have us believe. But it certainly is too loud. That defect in the balance of different items is noticeable with any sensitive speaker, and has already been the cause of much correspondence and complaint. It can, however, be easily remedied by the addition of an efficient volume control on the output valve. By means of such a control any item can be varied from a whisper to full strength to suit requirements, and the announcer's voice can be made a pleasure to listen to without the slightest trace of boominess, hissing or hissing.

May I conclude my defence of the moving coil with a repetition: use a diode rectifier and eliminate all reaction, back-coupling, and overloading of individual components.

And now, sir, if it is to come to cracking heads open after all, let the weapons be loud speakers, for I will back my 16 lb. pot any day against all the cardboard trumpets in Bedlam.

Ilford.

E. H. PALM.

**THE MACCALLUM SCHEME.**

Sir,—I have looked up Mr. G. B. Bennett's earlier letter, July 20th, 1927, and am very interested to find that a scheme so similar to my own should have been put forward nearly 2½ years ago. I imagine that a good many of us have been thinking along the same lines during the last few years, and in my own case I held my hand until I was quite sure that the synchronisation idea was entirely practicable, i.e., until Eckersley published his paper on the subject in April, 1929. Perhaps I ought to say I consider the essence of my scheme to lie in the grouping of programmes into classes and that I do not mind very much how the ideal is arrived at. The kind of alternative at present offered by the B.B.C. would not satisfy me at all.

Mr. Warren says that our land-lines are not good enough and indicates that it will take "at least five years" to put this right. I believe that the excellent engineers of the Post Office can give us the quality we desire, provided the money is forthcoming, and that the more important circuits at any rate could be brought up to the desired standard by the time the rest of the scheme is ready. I put it at about two years.

There is, of course, the alternative of the wireless link, and the possibilities of Dr. Robinson's new Stenode system should not be overlooked in this connection. It would seem possible by this means to feed the broadcasting stations from central high power stations, using fairly long waves, *without interfering with existing services*.

Mr. Warren's statement *re* the superiority of the B.B.C. regional scheme is somewhat dogmatic to say the least. My own view is that the programme grouping suggested by me would be more acceptable to the public, and I have yet to be convinced that mine is not a perfectly feasible proposal.

Mr. K. McCormack puts forward four propositions but, unlike Euclid, he does not prove them. The first two would appear to be true or untrue according to the meaning attached to the terms "restricted area" and "mutual interference," and, of course, everything depends upon the position, in reference to the mutually interfering stations, of the point at which the observations are made. The third is a corollary to the first two as is, very probably, the fourth, but as the meaning of the latter is not clear to me, I may be quite wrong in regarding it as such.

Mr. McCormack is an "anti-landliner" and an "anti-common-waveite," who demands good programmes and direct transmissions for "the provinces" on "an independent wavelength." Is there any practicable way of satisfying his requirements?

London, W.1.

H. MACCALLUM.

READERS

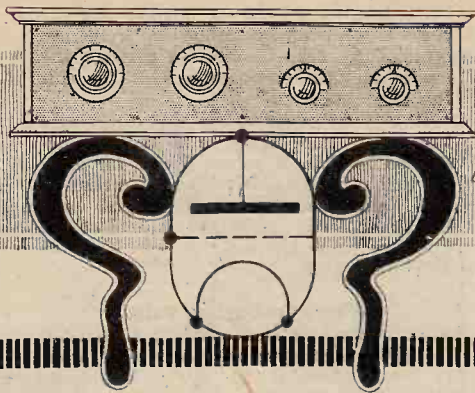

PROBLEMS

The "Wireless World" Supplies a Free Service of Technical Information.

The Service is subject to the rules of the Department, which are printed below; these must be strictly enforced, in the interest of readers themselves. A selection of queries of general interest is dealt with below, in some cases at greater length than would be possible in a letter.

**Incidental Rectification.**

By accident, the grid bias battery supplying voltage to my anode bend detector was completely short-circuited, with the result that the grid circuit was connected to the negative filament terminal. What puzzles me is the fact that the set still gave signals, though at reduced strength. How can a valve, connected in this way, work as a detector?

L. L.  
As a matter of fact, it is rather difficult to connect a valve, particularly if it be of the comparatively high-impedance type, with fairly low anode voltage, in such a way that it will not rectify slightly. Possibly the effect you have noticed is due to lack of complete "straightness" in the characteristic curve, or to asymmetrical conditions brought about by the flow of grid current: this will tend to restrict the development of voltage (across the tuned input circuit) due to impressed positive half-cycles as compared with that due to negative half-cycles.

**RULES.**

- (1.) Only one question (which must deal with a single specific point) can be answered. Letters must be concisely worded and headed "Information Department."
- (2.) Queries must be written on one side of the paper, and diagrams drawn on a separate sheet. A self-addressed stamped envelope must be enclosed for postal reply.
- (3.) Designs or circuit diagrams for complete receivers cannot be given; under present-day conditions justice cannot be done to questions of this kind in the course of a letter.
- (4.) Practical wiring plans cannot be supplied or considered.
- (5.) Designs for components such as L.F. chokes, power transformers, etc., cannot be supplied.
- (6.) Queries arising from the construction or operation of receivers must be confined to constructional sets described in "The Wireless World" or to standard manufacturers' receivers.

Readers desiring information on matters beyond the scope of the Information Department are invited to submit suggestions regarding subjects to be treated in future articles or paragraphs.

**Repairing Condenser Blocks.**

For smoothing purposes in my eliminator I am using a multiple condenser, with a number of separate elements. Unfortunately, one of the units (of 2 mfd.) has broken down, and I am wondering whether it would be possible for me to repair it myself. Will you give me a word of advice?

N. M.  
The internal connections of these multiple condensers are not always readily accessible, and it is sometimes rather difficult to remove a unit without doing damage. Further, you may not be able to get a replacement unit of suitable size. If you have any doubts as to your ability to do the repair, we advise you to get into touch with the makers.

**Grid Circuit Loading.**

In the description of the "1930 Everyman Four" mention is made of the fact that a certain value of detector anode by-pass condenser is chosen in order to minimise reduction of H.F. input due in grid circuit loading. This set has anode bend detection, and I was under the impression that, properly adjusted and operated, this method of rectification does not allow the flow of grid current and does not impose any loading on the circuit immediately preceding it. Will you please give me a word or two of explanation.

A. H. H.  
Unfortunately, it is incorrect to assume that an anode bend detector does not damp its tuned grid circuit. It has been appreciated for some time that there is a "reversed reaction" effect, via the valve capacity, that, under certain circumstances, may exercise a very serious influence in restricting signal voltage on the grid. This trouble is overcome to a great extent by a judicious choice of anode load values.

The whole subject was discussed at length in articles published in our issues of March 27th and May 22nd, 1929.

**H.F. Filament Switching.**

Will you please show me how a gramophone pick-up jack may be connected to the "New Kilo-Mag Four" in such a way that the H.F. valve filament will be automatically switched off when the plug is inserted?

C. N. R.  
The method of connection you require is given in Fig. 1. For this arrangement a "single closed filament" jack will be required.

It will be realised that the pick-up is connected across the contacts of the plug, and that insertion of this plug will automatically break the positive feed lead of the H.F. valve filaments as you require, and at the same time will make the necessary change in bias for converting the detector into an amplifying valve.

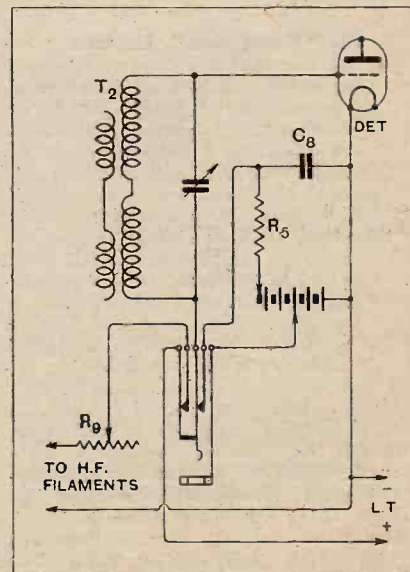

Fig. 1.—A pick-up jack arranged for automatic control of H.F. filament circuits.

**The Right Rheostat.**

My "Kilo-Mag Four" is working quite satisfactorily except for the fact that the rheostat controlling the H.F. valve filaments does not seem to function properly as a volume control; a very slight movement from the "full on" position has the effect of cutting out signals altogether. Can you suggest how this may be remedied?

A. D. G.

We expect that you are using two-volt valves (with a two-volt L.T. battery) and that the resistance of the rheostat is excessive. These valves consume considerably more current than those with four- or six-volt filaments, and consequently the voltage absorbed by a given series resistance is commensurately increased. We suggest the fitting of a rheostat with a maximum value of some 10 ohms.

○○○○

**Voltage Regulation.**

I have bought a small power transformer, rated to give an output of 4 amps. at 4 volts. It is proposed to use this for feeding the heaters of three indirectly heated A.C. valves, consuming a total of 3 amps.

Will you tell me what value of resistance should be inserted to prevent a rise in voltage across the heaters under this reduced load?

H. L. C.

Without seeing a regulation curve of your transformer, or its specification, it is quite impossible to give a definite answer to your query, but it can generally be assumed that these components, if made specifically for feeding the heaters of A.C. valves, are designed on fairly generous lines. Consequently, no appreciable rise in voltage is to be anticipated when a load only 25 per cent. less than maximum is imposed; but if you are still in doubt, it would be as well to refer the matter to the manufacturers.

○○○○

**The "Tuned Grid" Amplifier.**

From the fact that designers of receivers described in your journal do not seem to favour the "tuned grid" or "parallel feed" type of H.F. inter-valve coupling, I suppose it can be assumed that this method cannot approach the transformer in general effectiveness. Do you consider that it is worth while to include it in a receiver from which a moderately good standard of performance is required? I ask this because I already have a spare H.F. choke, and also because it is desired to simplify waveband switching as much as possible.

B. T. F.

It is quite wrong to think that the parallel-fed H.F. amplifier is ineffective, although there was at one time a fairly general tendency, due to an imperfect appreciation of the considerations involved, to belittle its possibilities.

Generally speaking, this arrangement is but little inferior to transformer coupling, and has advantages of its own in the matter of easy wave-changing. The H.F. choke through which the valve

anode is fed should be of the highest possible efficiency; possibly the circuit has occasionally been condemned through the use of an indifferent component for this function.

It may be pointed out that the single tuned-grid H.F. stage of a receiver described in *The Wireless World* for May 1st and May 8th, 1929, gave a measured H.F. amplification averaging well over 200 times. The theoretical aspects of the question were discussed in our issue of July 10th, 1928.

○○○○

**Where Decoupling Fails.**

Since adding an H.T. battery eliminator (D.C. mains) to my receiver, I have been troubled by L.F. oscillation, and in an attempt to put matters right, have inserted decoupling resistances (of course with suitable by-pass condensers) in the anode circuits of the detector and first-stage L.F. valves. Much to my disappointment, this has not completely cured the fault, although it has effected an improvement. What do you suggest should be my next step?

B. B. W.

There is a tendency to forget that the decoupling scheme was first suggested as a remedy for L.F. oscillation brought about by battery resistance, and, as has been pointed out on several occasions in this journal, this scheme must not be expected to provide a perfect cure for self-oscillation produced by high impedances in an eliminator, unless special precautions are taken in its application.

If you will send us a circuit diagram of your receiver and eliminator, it is probable that we can make some helpful suggestion, and in the meantime we suggest that you would do well to divide up the various feed circuits, being guided by the design of the D.C. eliminator described in our issue of August 29th, 1929. Adoption of this plan avoids the inclusion of high impedances common to several anode circuits.

**FOREIGN BROADCAST GUIDE.****STAMBOUL**

(Turkey).

Geographical Position: 28° 51' 48" E.  
41° 11' 19" N.

Approximate air line from London: 1,550 miles.

Wavelength: 1,200 m. Frequency:  
250 Kc. Power: 5 kW.

**Standard Daily Transmissions.**

15.30 G.M.T. Turkish music, news and agricultural report; 16.30 orchestral concert; 18.30-20.30 (except Mondays) music and news.

Male Announcer. Call (in Turkish): *Allo! Telsiztelegrafie Istanbul.* (In French): *Allo! Ici Radio Stamboul.*

Interval signal: metronome (120 beats per minute).

Closes down with the Turkish National Anthem.

**A Megavox Modification.**

Will you please tell me if a Mazda 215 S.G. valve would work satisfactorily as an H.F. amplifier in the Megavox III receiver? Would any alterations be necessary in the set itself?

C. L. G.

This valve will work excellently, and no alterations will be necessary beyond the addition of a voltage-absorbing resistance in series with its filament, if you are using 4-volt or 6-volt valves in the other positions.

○○○○

**The Limit of Amplification.**

My receiver, made nearly two years ago, comprises a screen grid H.F. amplifying valve, detector, and one L.F. stage; there is a plain vertical metal screen between the tuned grid and plate circuits. The set is hardly selective enough for my present needs, and in addition is somewhat lacking in sensitivity as compared with more modern receivers.

Do you consider that it would be possible to improve matters by using coils of lower H.F. resistance, or is it likely that this alteration would cause instability?

T. W. J.

Without full details of your present set, it is not possible to offer a definite expression of opinion, but in all probability your fears are well grounded, and we doubt if it would be possible greatly to improve the receiver in the way you suggest.

It should be added, however, that if the set does not show any marked tendency towards self-oscillation at the lower end of the tuning scale, at least some improvement can be effected by using better coils.

○○○○

**Power Line Interference.**

When my receiver was fed from H.T. batteries, power circuit interference was never heard, but since using an eliminator, I am troubled by periodic interference, which is clearly due to this cause. It should be made quite clear that the trouble is not due to imperfect smoothing in the eliminator, as the interference is sometimes absent for considerable periods, particularly at week-ends. Can you make a suggestion as to any means whereby it may be overcome?

C. H.

Your description would indicate that high-frequency interference, possibly generated by electrical machinery at a considerable distance, is being conveyed along the power lines to your set via the eliminator.

We think it would be worth while to connect H.F. chokes in the leads between eliminator and receiver, and also to make sure that adequate by-pass condensers are fitted.

It is also worth while to try the effect of using a counterpoise in place of an earth, and also of a loosely coupled and separately tuned aerial circuit, if this is not already included in your circuit.

A 38

# CHALIAPINE

*believes his ears!*

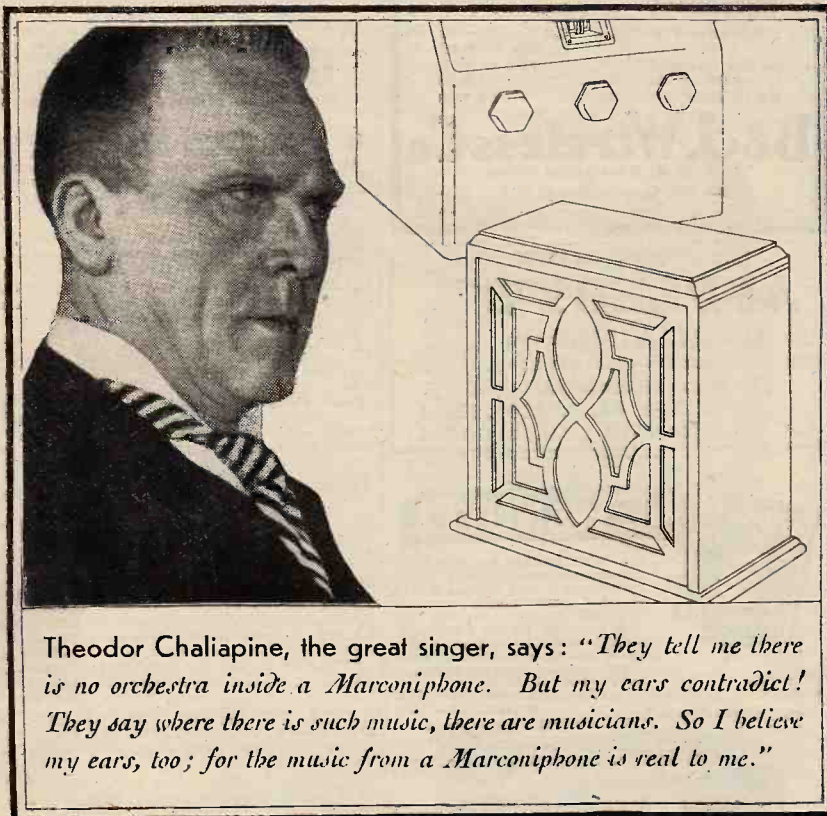

Theodor Chaliapine, the great singer, says: *"They tell me there is no orchestra inside a Marconiphone. But my ears contradict! They say where there is such music, there are musicians. So I believe my ears, too; for the music from a Marconiphone is real to me."*

To hear every smallest detail of the programme, every note in the musical scale, every inflexion of the voice — radio as it really should be — a Marconiphone loud speaker!

Marconiphone engineers make these speakers. All the skill of thirty years' leadership in wireless is in their construction. Sir Edward Elgar, Albert Coates, Mischa Levitski, Peter Dawson, many other famous musicians delight in their clear tone, their unfailingly accurate reproduction. Any dealer will willingly demonstrate the Marconiphone speakers to you. If there is no dealer near you, write to The Marconiphone Company Limited, 210-212 Tottenham Court Road, London, W.1.

THE FIRST AND GREATEST  
NAME IN WIRELESS



*Listen with a*

## MARCONIPHONE LOUD SPEAKER

### MARCONIPHONE MOVING COIL SPEAKER *(shown on left)*

The most sensitive speaker you can buy, the Marconiphone Moving Coil. Responding fully, evenly to all tone frequencies, it gives perfect results equally from a two- or a multi-valve receiver. Units from £4.10.0. Cabinet models: for 6-volt accumulator, £7; for D.C. mains, £7.10.0; for A.C. mains, £12.12.0.

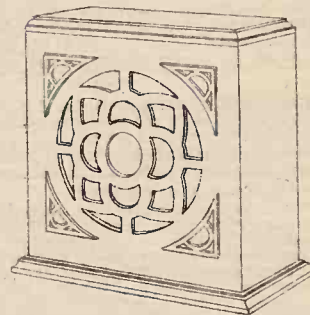

### MODEL 60 CABINET CONE

Obtainable at the very moderate price of £3, the Model 60 is an extremely efficient "all-purpose" speaker. Made on the latest lines and embodying the Marconiphone reed-system, its tone is outstandingly good.

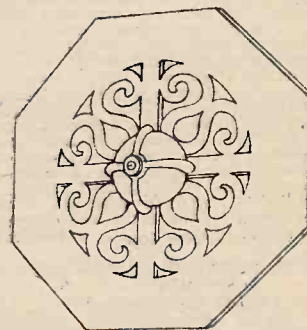

### A FIRST-CLASS CONE SPEAKER ... FOR 30/- 1

The Octagon Cone is a well-established favourite, giving excellent reproduction from a 2- or a 5-valve receiver. Made in two different and pleasing designs, it can be placed on the table or hung from the wall.



# MISCELLANEOUS ADVERTISEMENTS.

## NOTICES.

**THE CHARGE FOR ADVERTISEMENTS** in these columns is:

12 words or less, 2/- and 2d. for every additional word.

Each paragraph is charged separately and name and address must be counted.

**SERIES DISCOUNTS** are allowed to Trade Advertisers as follows on orders for consecutive insertions, provided a contract is placed in advance, and in the absence of fresh instructions the entire "copy" is repeated from the previous issue: 13 consecutive insertions 5%; 26 consecutive, 10%; 52 consecutive, 15%.

**ADVERTISEMENTS** for these columns are accepted up to **FIRST POST ON THURSDAY MORNING** (previous to date of issue) at the Head Offices of "The Wireless World," Dorset House, Tudor Street, London, E.C.4, or on **WEDNESDAY MORNING** at the Branch Offices 19, Hertford Street, Coventry; Guildhall Buildings, Navigation Street, Birmingham; 260, Deansgate, Manchester; 101, St. Vincent Street, Glasgow, G.2.

Advertisements that arrive too late for a particular issue will automatically be inserted in the following issue unless accompanied by instructions to the contrary. All advertisements in this section must be strictly prepaid.

The proprietors retain the right to refuse or withdraw advertisements at their discretion.

Postal Orders and Cheques sent in payment for advertisements should be made payable to **ILLIFFE & SONS Ltd.**, and crossed **Notes** being untraceable if lost in transit should not be sent as remittances.

All letters relating to advertisements should quote the number which is printed at the end of each advertisement, and the date of the issue in which it appeared.

The proprietors are not responsible for clerical or printers' errors, although every care is taken to avoid mistakes.

### NUMBERED ADDRESSES.

For the convenience of private advertisers, letters may be addressed to numbers at "The Wireless World" Office. When this is desired, the sum of 6d. to defray the cost of registration and to cover postage on replies must be added to the advertisement charge, which must include the words Box 000, c/o "The Wireless World." Only the number will appear in the advertisement. All replies should be addressed No. 000, c/o "The Wireless World," Dorset House, Tudor Street, London, E.C.4. Readers who reply to Box No. advertisements are warned against sending remittance through the post except in registered envelopes; in all such cases the use of the Deposit System is recommended, and the envelope should be clearly marked "Deposit Department."

### DEPOSIT SYSTEM.

Readers who hesitate to send money to unknown persons may deal in perfect safety by availing themselves of our Deposit System. If the money be deposited with "The Wireless World," both parties are advised of its receipt.

The time allowed for decision is three days, counting from receipt of goods, after which period, if buyer decides not to retain goods, they must be returned to sender. If a sale is effected, buyer instructs us to return amount to seller, but if not, seller instructs us to remit amount to depositor. Carriage is paid by the buyer, but in the event of no sale, and subject to there being no different arrangement between buyer and seller, each pays carriage one way. The seller takes the risk of loss or damage in transit, for which we take no responsibility. For all transactions up to £10, a deposit fee of 1/- is charged; over transactions over £10 and under £50, the fee is 2/6; over £50, 5/-. All deposit matters are dealt with at Dorset House, Tudor Street, London, E.C.4, and cheques and money orders should be made payable to Illiffe & Sons Limited.

### THE SALE OF HOME-CONSTRUCTED UNLICENSED APPARATUS.

#### A Service to our Readers.

We have made an arrangement with the Patentees whereby readers who wish to dispose of a home-constructed receiver not licensed under the patents made use of, can license the set by means of the Deposit System referred to above.

The person desiring to sell, in sending us particulars for his advertisement, will in every case make use of a Box No., and should add to the price which he requires the amount of royalty customarily paid by manufacturers.

If the purchaser is satisfied with his purchase, the sum realised will be forwarded to the seller, less the amount due in respect of royalties, which amount will be paid by "The Wireless World" to the owners of the patents concerned, and a certificate will be handed on to the purchaser of the set.

**SPECIAL NOTE.**—Readers who reply to advertisements and receive no answer to their enquiries are requested to regard the silence as an indication that the goods advertised have already been disposed of. Advertisers often receive so many enquiries that it is quite impossible to reply to each one by post.

## ALL WIRELESS WORLD COILS

1930 EVERYMAN FOUR	47/6 set
KIT SET, Coils with Switches	45/- set
NEW KILOMAG.	45/- set
RECORD III	45/- set
FOREIGN LISTENERS 4 B.B.C.	30/- set
	5XX 37/6 set
METAL CABINETS	38/6 to 46/6
5 1/2" DRUM DIALS with Escutcheons	5/6
WAVE TRAP, Litz Wire	10/6 each

## B&J. Wireless Co.

2, 3, & 4, Athelstane Mews,  
Stroud Green Road, N.4.

Archway 1695

"END OF YEAR CLEARING."

## APPLEBY'S

FOR BARGAINS WATCH Phone: Paddington 8828 (3 lines)

THE MISCELLANEOUS COLUMNS THIS MONTH.

For Modern High-grade Material Only.

**CHAPEL ST., LONDON, N.W.1**

OPEN TILL 7 P.M. SAT. 1 P.M.

## NEW & NOVEL

The Patent "DORIC" Cabinet is really high-class and superbly finished. Unique sectional construction allowing it to be assembled in a few minutes without the aid of nails or screws. Perfectly rigid when assembled, forming a cabinet fit for the housing of the most costly radio set. Packs flat in card box when sent by post, thus minimising risk of damage. Cabinet to suit any circuit.

BUILD YOUR OWN CABINET FRENCH POLISHED MAHOAGNY OR OAK WITH HINGED LIDS

Prices—Loose Base Board included:		
Panel	Depth	Price
12" x 7" x 7"	21/- net	18" x 7" x 10" 30/- net
16" x 7" x 9"	27/6	21" x 7" x 9" 33/- net
18" x 8" x 8"	Special for Music Magnet, 30/- net.	

Any size made to order at proportionate price.  
Postage 1/- extra. Cash with order or O.O.D.

Trade enquiries welcomed. Quotations given for Special Cabinets.  
Manufactured only by—  
**Thomas O'Brien Ltd., Slater St., Seel St., Liverpool.**

MUCH IMITATED

## CLAROSTAT

NEVER EQUALLED

REDUCED PRICES!

STANDARD. WAS 10/6 NOW 9/6

VOLUME. " 8/6 " 7/6

POWER TYPES. WERE 15/- " 13/6

FREE

40 Page Illustrated Booklet with Scale Drawings all types mains apparatus etc.

## CLAUDE LYONS LTD.

76, OLDHALL ST., LIVERPOOL.

## RECEIVERS FOR SALE.

**SCOTT SESSIONS and Co.**, Great Britain's Radio Doctors.—Read advertisement under Miscellaneous. [0254]

**3-VALVE** All-wave Receiver, latest type, powerful, perfect; £4.—V. Taylor, 57, Studley Rd., Stockwell, London. [0274]

**RECEIVERS** for Sale.—Portable 5-valve, suit case type, complete, as new, perfect; £9/17/6.—N. Taylor, 57, Studley Rd., Stockwell, London. [0323]

**WIRELESS** Portable Sets, with 5 Cossor new process valves, for 9 guineas; less than components cost, comparable with any set double this price. Royalty paid; seen between 1 and 2 p.m., or particulars sent on receipt of stamped addressed envelope.—G. Hodgson, 53, Windsor House, Victoria St., Westminster. [7737]

**READ and MORRIS, Ltd.**, the mains pioneers, who in 1925 equipped the hospital with mains sets, still supreme in all-mains receivers and units.

**LOW Tension A.C. Eliminator**, permanently replacing batteries, now only £5/15; electrolytic condensers, 2,000 m.f., as used in above, 13/-; including postage.

**BARGAINS.**—Second-hand sets, units, meters, speakers.—Read and Morris, Ltd., 31, Eastcastle St. (facing back of Warrings), Oxford St., W. [7769]

**SUPER** Range 3-valve Set, guaranteed genuine, complete with all accessories, new; 9 guineas; approval 7 days. Box 4377, c/o The Wireless World. [7828]

## APPLEBY'S.

### APPLEBY'S Bargains.

The Following Slightly Used Material is Offered subject to sale; every article will be severely tested before despatch, and guaranteed in workable condition; the following items quoted are nett cash and carriage paid in Great Britain:

**RESIDUE** of Receivers.—One only left, McMichael Screened Domic Three receiver, in oak, with set of three tested valves, as new, £10/15; one only left, Geophone Superhet. receiver, complete with set tested valves and frame aerial, condition perfect; £12/15; one only left, Marconi 5-valve portable receiver, complete, £13/10; one only left, Aeonie 5 valve portable receiver, complete, £8/10; one only, Geophone 3-valve S. wave receiver, condition perfect, £7/10.

**NOW.**—Send now; many clients were disappointed by material having been sold previous to their application, for sets advertised a week or so ago.

**APPLEBY'S**, Number Forty-four Chapel St., Marylebone, N.W.1 (four minutes from Oxford St. London). [0316]

**MULLARD** Portable Five, absolutely complete, superb reception, British and Continental, show cabinet; £8; hear alter 6.—2, Dollis Hill Av., Cricklewood, N.W.2. [7949]

**5-VALVE** Portable, new; 9 guineas; complete with valves and batteries.—Box 4510, c/o The Wireless World. [7945]

**FERRANTI** 5-valve, push-pull amplifier, twin turntables, Magnavox speaker on 3ft. baffle, all new; cost £56, accept £30; delivered within 100 miles.—Bradford, Entertainer, Whitechurch, Bristol. [7943]

**WESTERN** Electric 7-valve Superheterodyne Receiver, perfect, complete with frame, batteries and loud-speaker; cost £60, sacrifice, £17 or nearest.—Sloan 1720. 15, Hobart Place, S.W.1. [7935]

**COSSOR** Screened Grid 4-valve Receiver, 2 Siemens 60-volt power batteries, 1 Edison accumulator and best quality cone loud-speaker, complete; 10 guineas; seen any day after 7 p.m., or write S. M., 129, Queen's Rd., Finsbury Park, N.4. [7941]

**OSRAM** Music Magnet, with valves, good condition; £4/10.—Murray, Coldstream, Berwickshire. [7939]

**GENUINE** Fada (not Kit) 5-valve All-wave, perfect; cost £21, accept £7 or near offer.—Owner, 45, Elm Grove, S.E.15. [7938]

**SCREENED** Grid Portable, new; just cost £22, sacrifice, £15, complete.—Sloan 1720. 15, Hobart Place, S.W.1. [7936]

**MARCONI** Model 82 Superhet, with 8 or 9 valves, perfect condition, heard evenings; cost £65, accept £15 or near offer.—Box 4482, c/o The Wireless World. [7933]

**3-VALVE** Set, screen, det., power valves, set Colvett 3 long coils, batteries and speaker, £6; 2-valve set, with valves, 50/-; National portable, £8.—Northfield Radio, 157, Northfield Av., West Ealing. [7931A]

"**WIRELESS** World" New Empire Short Wave Set for Sale, in perfect condition, with valves and 5 coils covering short, medium and long wavebands; £10; owner makes new set every year.—Box 4473, c/o The Wireless World. [7931]

**NEW** Everyman Four, S.G. det., 2 L.F., in self contained oak cabinet, size 38in x 35in x 12in, 120v. H.T. accumulator with A.C. charger, latest cone speaker, 25 stations; cost £40, in perfect condition, accept £12.—Smith, 46, Lynnwood Rd., Tooting, S.W.17. [7929]

Mention of "The Wireless World," when writing to advertisers, will ensure prompt attention.

**Receivers for Sale.—Contd.**

**McMICHAEL** Super Range Portable Four, almost new, also Blue Spot unit and cone, also Amplion unit and Gillman Power chassis, with cone; £21 the lot.—Stone, 827, Wimborne Rd., Bournemouth. [7985]

**LANGHAM** Transatlantic Five, leather case, slightly damaged. £5; Pye Portable Five, perfect condition. £10.—Wyatt, 8, Wills St., Lzells, Birmingham. [7977]

**R.I.** 3-valve A.C. Set, unused, lid slightly scratched, demonstrated 10 miles round Manchester; cash, £22/10.—Box 4533, c/o *The Wireless World*. [8010]

**NEW**, unused. 18-guinea Marconiphone portable model 55 for sale, as despatched from maker, still unpacked; 17 guineas or near offer.—Box 4462, c/o *The Wireless World*. [7923]

**PHILLIPS** 3-valve All Mains Set, 240v., A.C., as new; £18.—Box 4520, c/o *The Wireless World*. [7963]

**MAGIC** Three, used a few times, long and short wave coils, valves, complete except cabinet; £4.—Goulding, 112, Verdant Lane, Catford, S.E.6. [7960]

**OSRAM** Music Magnet Kit, without valves, cost £6/15, accept £5; Brandes Table Talker, 12/6.—80, Cloughton St., St. Helens. [7956]

**WE** Offer You the Following Inducements to Purchase Your New Receiver or Other Apparatus from us.

**FIRSTLY**—Unbiased advice. The Principal of the firm has twenty years' professional wireless experience, having been at Government Experimental Stations in 1910. He has been Manager for the Starling Telephone Co., radio expert to the G.E.C., and Chairman of the Technical Committee of the National Association of Radio Manufacturers. His advice has saved our clients many thousands of pounds, for, as everybody knows, there is no hobby on which more money is wasted in useless apparatus by the uninitiated.

**SECONDLY**—We take your old apparatus in part exchange for new. Send us a list of your old apparatus, or, better still, send us the apparatus, and state your new requirement. We will then make our offer for your goods, and if you do not approve, which is unlikely, we will return the parcel, carriage paid.

**IF** you are in Doubt as to the Make of Receiver or other Apparatus you should Purchase, write to us, and we will advise you; we have no leaning towards any particular maker, and will tell you the particular instrument you should buy for your purpose.

**SCIENTIFIC DEVELOPMENT Co.**, 51, Fishergate, Preston. Tel.: 1364. [0226]

**SIMMONDS BROS.**—Receivers constructed to your own or any published design; also repairs, reconstructions; and modernisations at moderate charges; best materials and workmanship guaranteed; numerous testimonials; quotations free.—Address, Shireland Rd., Sneathwick. [5882]

**3-VALVE** Screened Grid Transportable, for A.C. mains, completely self contained, beautiful cabinet, amazingly selective and sensitive, superb production, no hum, brand new; £22/10; sent on approval.—Heaton, 42, Green Lane, Thornton Heath, Surrey. [7994]

**G.E.C.** 3-valve, H.T., L.T., valves, aerial and speaker, new; £9/10.—Cobb, Cumberland Place, Walspool. [8008]

**1930** Cossor Kit, seals unbroken (unwanted gift), £7/10; Muller 104v. 5-tube A.C. power valve, 3 weeks' use, 7/6; Tudor Monolt, 6v. 30 a.h., nearly new, cost £2, 17/6 or offer; on approval willingly.—Phillips, 7, Whitechurch Gardens, Edgware. [7995]

**TRUPHONIC** 5-valve Transportable, in beautiful Japanese cabinet, no aerial required, complete, £7; also neodyne set; wanted, gramophone, late model.—E., 75, Heath St., Hampstead, N.W.3. [7992]

**MEGA VOX** Three, exactly to specification, valves, coils and Phillips H.T. eliminator, no cabinet, a splendid instrument; £13, bargain.—Gaunt, Layton Lane, Rawdon, Leeds. [7989]

**ACCUMULATOR HIRE.**

**DON'T** Buy Accumulators or Dry Batteries, join our C.A.V. low- and high-tension accumulator hire service, the largest and best in London; better and cheaper reception with no trouble; regular deliveries within 12 miles of Charing Cross; no deposit, payment on each delivery or by quarterly subscription; over 10,000 satisfied users; explanatory folder, post free; phone or write to-day.—Radio Service (London), Ltd., 105, Torrillano Av., N.W.5. Phone: North 0623-4-5. [7596]

**C.D.E.S.** Accumulator Hire and Maintenance Service (5 mile radius).—98, Cherry Orchard Rd., Croydon. [6374]

**BATTERIES.**

**WET H.T.** Replacements.—Sacs (capped or uncapped), highest grade, No. 1, 10d. per doz.; No. 2, 1/9 per doz.—See below.

**ZINCS.**—Best quality (wired), No. 1, 8d. per doz.; No. 2, 9d. per doz.; orders valued 5/- carriage paid, otherwise 6d. for postage.—British Battery Co., Clarendon Rd., Watford, Herts. [0258]

**WET H.T. Batteries.**—Parts per dozen, jars, No. 1, 2 1/4 x 1 1/2 square, 1/3; No. 2, 1/6; zincs, No. 1, 10d.; No. 2, 11d.; sacs, No. 1, 1/2 dozen; No. 2, 1/3; terminals, 8d., 10d.; dozen cells (18 volts), complete with bands and electrolyte, No. 1, 4/1; No. 2, 5/-; post 9d.; high efficiency, long life, self charging, upkeep small; send 6d. for sample unit; illustrated booklet free, carriage free order 10/-; write for free list wireless bargains, trade supplied.—W. Taylor, 57, Studley Rd., Stockwell, London. [0039]

*The finest Loudspeakers in the world in their class*  
**EPOCH**  
Moving Coil Speakers.

Models 99 and 66 are the standard of comparison in many of the famous laboratories of the world. The speakers that have made Radio as enjoyable as the best concerts. 14 different models for all requirements, from £2 10 0 upwards.

Write for Booklet W.S. giving full particulars and the 7 days free trial offer.



*Our Latest Triumph!*  
**Epoch**  
Super-Cinema Model

The most powerful speaker ever put on the market, and the most sensitive too! Many times as sensitive as an ordinary moving-coil speaker. Such superb quality has never been heard before. Delivers enormous volume and wonderful quality from the most modest of sets. The speaker for the home, public entertainments or Talks!

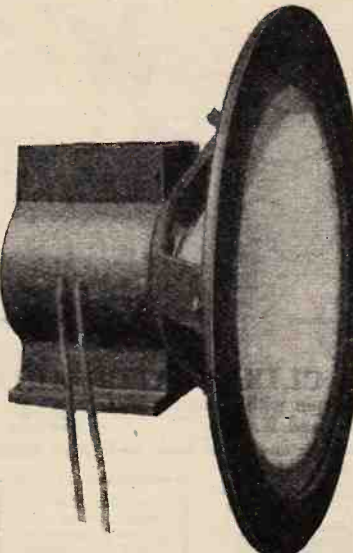

**EPOCH RADIO MANUFACTURING CO., LTD.,**  
are the manufacturers.

City Office & Service Station: 3, Farringdon Avenue (Ludgate Circus end), E.C.4  
Phone: Central 1971 (2 lines). Private Branch Exchange.

**Batteries.—Contd.**

**H.T.** Accumulator, Oldham 120-volt, complete in case, carrying handle, excellent condition; 45/- Broughton, 13, Viga Rd., N.21. [7927]

**PENTODE** Users.—Write for details of new size self-charging wet battery; 20,000 milliamperes, 6d. per volt; illustrated catalogue giving data, post free.—U. Taylor, 57, Studley Rd., Stockwell, London. [0273]

**CHARGERS AND ELIMINATORS.**

**VORTEXION** Transformers, chokes, etc., wound to any specification; write or phone for quotation; best quality components only.—Vortexion, 72, Merton Rd., Wimbledon, S.W.19. Tel.: Wimbledon 2814. [0319]

**TANTALUM** and Liumion for A.C. Rectifiers; make up your own inexpensive chargers; blue prints for H.T. and L.T., 1/- each; Liumion electrodes fitted with terminals, 2-3 amps. and 5-8 amps.—Blackwell's Metallurgical Works, Ltd., Speke Rd. Works, Garston, Liverpool. Phone: Garston 980 (2 lines). [6282]

**PHILIPSON'S** Safety High Tension Battery Eliminators.

**10/-** Down and the Balance in Easy Monthly payments secures the finest high tension supply available.

**PHILIPSON'S** Safety Eliminators are Guaranteed for 12 Months.

**PHILIPSON'S** Safety Eliminators are the Cheapest to Install and the Cheapest to Run; prices: Model A.C.5 24/17/6, A.C.7 23/17/6, complete with full wave, rectifiers; D.C.4 37/6, D.C.5 25/-.

**ALL** Models Obtained for 10/- Deposit; take advantage of this and get constant high tension immediately.

**WRITE** for Our Booklet, "Radio Power" to Philipson and Co., Ltd., Radio Engineers, Astley Bridge, Bolton. Phone: 2038. Grams: Safety, Bolton. Est. over 50 years. [0318]

**CHEEROS**—Cheeros for all types of transformers and chokes, high grade instruments at a very moderate price; enquiries invited.—Chester Bros., 244, Dalston Lane, London, E.8. [5290]

**TRANSFORMERS** and Chokes for Battery Eliminators all wireless purposes, receiving or transmitting; enquiries invited.—Chester Bros., 244, Dalston Lane, London, E.8. [7587]

**FEL-ETRIO** High Tension Eliminator Kits, improved output 15 milliamps at 120 volts; complete; 25/-.

**FEL-ETRIE** Eliminator Kits are the Best and cheapest in England; complete, 25/-.

**FEL-ETRIO** Kits are Complete, except valve, and we recommend Philips 373; 15/-.

**FEL-ETRIO** Kits have been Sold in Hundreds, and are guaranteed, satisfaction or money returned.

**FEL-ETRIE** Kit will be sent c.o.d. if desired. State voltage and periods, also whether Philips valve is required at 15/- extra.

**FEL-ETRIE** Eliminator Kit is Post Free; price 25/-.

**FOLDER** and Lists on Request to Fel-ETrie Radio, 56, Garden St., Sheffield. [7742]

**SAVAGE'S** Specialise in Wireless Power from the Mains, reliable apparatus at reasonable prices.

**SAVAGE'S**—Transformers laminations and bakelite bobbins; intending home constructors should write for list.

**SAVAGE'S**—Reliable smoothing condensers, 1,000 volt D.O. test, 1 mid., 2/-; 2 mid., 3/-; 4 mid., 5/3; 500 volt D.O. test, 1 mid., 1/6; 2 mid., 2/3; 4 mid., 3/9.

**SAVAGE'S**—Super smoothing and output chokes, many types available; write for list.

**SAVAGE'S**—Mains transformers for Westinghouse H.T.4 unit, 18/6; A.3, 17/-; A.4, 20/-.

**SAVAGE'S**—Mains transformers for Westinghouse H.T.4, with additional winding, 4 volts 3 amps., 23s.

**SAVAGE'S**—Mains transformers V.T.31, 200-0-200 volts, 60 amps., 2+2 volts 2 amps, 2+2 volts 3 amps, 28/-.

**SAVAGE'S**—Mains transformers V.T.35, 250-0-250 volts 60 amps., 2+2 volts 1 amp., 2+2 volts 3 amp., and, for automatically biased super power valve, 3+3 volts 5 amp., 33/-.

**SAVAGE'S**—Mains transformer B.T.3, 500-0-500 volts 120 amps., 3.75+3.75 volts 3 amps., 3+3 volts 3 amps., 2+2 volts 3 amps., 51/-.

**SAVAGE'S**—Mains transformers and power chokes are carefully and individually constructed from first class materials with an exceptionally generous margin of safety.

**SAVAGE'S**, 146, Bishopsgate, London, E.C.2. Phone: Bishopsgate 6998. [7976]

**PHILIPS** H.T. Charger, 120v. 60 m.a., 230v. A.C. 50 cycles, perfect, Climax L.F. choke; what offers?—J. Waite, Helmsshore, Manchester. [7928]

**OLDHAM** A.C. H.T. Charger, 130 volts, accumulators, voltmeter, hydrometer, lot 24/10.—Particulars, Garside, 916, Oakview, Linthwaite, Huddersfield. [8004]

**ATLAS** A.C.16 Eliminator, full wave, input 200-250v., output 25 m.a., 0-100, 120, 150v., nearly new, owner leaving district.—Pullan, 1, Old Rd., Billingham, Stockton-on-Tees. [7988]

**BRITISH** Made Transformers for Westinghouse Rectifiers, universal primary 200-250 volts, 50 cycles, outputs 135v. 70 m.a., 2-0-2v. 3 amps, 17/6; chokes, 40 henries 35 m.a., 11/-; 50 henries 100 m.a., 18/6, post free; list on request.—C. F. Gibbs, Pennygate, Spalding. [7980]

**CABINETS.**

**ARTCRAFT** Radio Cabinets are Britain's Best Value. [0313]

**DIGBY'S** Cabinets—Table models in solid oak and mahogany; from 11/6 to 71/-.

**DIGBY'S** Cabinets, fitted with Radion or Resiston ebonite if required.

**DIGBY'S** Cabinets.—Pedestal model, with separate battery components; from 56/- to £12.

**DIGBY'S** Cabinets Made to Customer's Own Designs.

**DIGBY'S** Cabinets.—Write for new 16-page art catalogue.—P. Digby, 9, The Oval, Hackney Rd., E.2. Phone: Bishopsgate 6453.

**ARTCRAFT** Radio Cabinets; Britain's best value; lowest prices consistent with highest quality; illustrated list free from actual manufacturers.—Artercraft Co., 156, Cherry Orchard Rd., Croydon. Phone: Croydon 1981. [0040]

**CABINETS**, 16 1/2 in. x 7 1/2 in. x 11 in., hand mahogany, finished 7/6, unpainted 5/6; oval front, 10 1/2 in. x 6 1/2 in., 6 extra; portable cabinets, 16 1/2 in. x 16 1/2 in. x 8 in., £1/5; baseboard, 6d.; carriage free.—F. W. Hamser, 63, Shattisbury St., London, N.1. Clerkenwell 7139. [7584]

**ARTCRAFT** Radio Cabinets are Britain's Best Value. [0311]

**KAY'S** Cabinets, the greatest range of pedestal cabinets in the kingdom; original creative designs at prices 50% lower than elsewhere; quotations for specials by return; delivery at short notice guaranteed; moving coil, portable, baffle, vignette, radiogram, electric pick-up, television, etc.; illustrated lists free.—H. Kay, Wireless Cabinet Manufacturer, Mount Pleasant Rd., London, N.17. Phone: Walthamstow 1626. [7745]

**ARTCRAFT** Radio Cabinets are Britain's Best Value. [0310]

**ACONE** Speaker Cabinet of Distinction.—Solid selected figured oak fret and case, 12 in. x 12 in. x 5 1/2 in. inside, extra strong 6 mm. plywood back for fixing unit, rubber feet or baize, state which, polished rich dark oak, unless otherwise ordered, 8/9 each, carriage paid, unpainted, but quite ready for staining and polishing, 7/6 each, carriage paid.—Manufacturer, W. T. Tucker, 2, Vincent St., Balsall Heath, Birmingham. Phone Calthorpe 2435. [7850]

**ARTCRAFT** Radio Cabinets are Britain's Best Value. [0309]

**RADIO-GRAMOPHONE** Cabinets, sideboard radio-gramophones, radio cabinets; write for 1930 catalogue.—R. Baker, 407, Hackney Rd., E.2. [7930]

**COILS, TRANSFORMERS, ETC.**

**1,000-OHM** Decoupling Resistances for "Wireless World" Circuits; 1/6 each, post free.—Groves Bros., St. Mary's Place, Shrewsbury. [7833]

**RADIOGRAPH**—W.W. coils, Record III, 35/-; new Kilo-Mag Four, 33/-; S.G. Regional, 37/6; foreign listeners' Four, 37/6 set; Europa Portable, 21/-; Europa III, 18/6; S.G. multi-valve portable, 22/6; new Everyman Four, 42/6.

**RADIOGRAPH**—Litz wire, 9/40, 1/6; 27/42, 2/6 dozen yards; Redfern's deep ribbed or Beol tube, 5d. per inch, slotting 1/6 extra.—Station Rd., Handsworth, Birmingham. [7914]

**600-OHM** Decoupling Resistances for New Kilo-mag Four, foreign listeners' four, and all "Wireless World" circuits, hand made and tested in our own workshops; improved model, 1/6 each, post free.—Groves Bros., St. Mary's Place, Shrewsbury. [7832]

**SIMMONDS BROS.**—Berclif coils, Record Three, 50/- pair; new kilo-mag. four, 50/- set; foreign listeners' four, low, 30/-; long wave, 37/-; screened grid Regional, 40/-; Mullard S.G.P. dual range coils, 30/- pair; Berclif standard coils, for new all-wave four, standard four, A.C. three, Everyman four, etc., 63/6 set of 4, with bases; the same coils for the Lodestone series ("Wireless Magazine"), 65/9 set of 4, with bases; Titan unit, 15/-; decoupling resistances, 600 ohm, 1/6; 1,000 ohm, 2/-; all "Wireless World" and similar coils in regular production by the leading specialists; list free; trade supplied.—Simmonds Bros., Shireland Rd., Smethwick. Tel.: Smethwick 751. [6314]

**CLIMAX** Transformer, with U5 valve, used 100 hours; 25/-.—Box 4532, c/o The Wireless World. [8000]

**NEW Kilo-Mag Four** Coils, 37/6 set; ebonite formers (slotted), for winding, 12/6 set of 3; all post free; trade supplied.—Groves Bros., St. Mary's Place, Shrewsbury. [7975]

**DYNAMOS, ETC.**

**DYNAMOS.** Dynamos. Dynamos.—Great clearance; Crompton 4-pole, shunt wound, 50-75 volt 20-30 amp., £7/10; Crompton shunt wound 4-pole 30 volt 10 amp., £7/10; C.A.V. shunt wound 4-pole 30 volt 10 amp., £2/10; out-out to suit, 10/-; Siemens 50-75 volt 10 amp. slow speed, £7; Newton 110 volt 20 amp. ball bearings, £10; 200 volt 20 amp., £10; compound wound, £2 extra; Crompton 100 volt 3 amp., £3; B.T.H. charging generators, double wound, outputs 6 volt 5 amp. and 150-200 volts 110 milliamp., 50/-; Holmes heavy type 200 volt 40 amp., £15; new 2 h.p. Lister engines, 2 years' guarantee, £18; charging switchboards, high class fittings, fully mounted, £10; switchboard meters, any range, 17/6; shunt regulators, 20/- each; Neville type cut-outs, mercury break, 32/-; all machines guaranteed as new, on approval against cash; also a large stock of A.C. and D.C. charging motors, A.C. and D.C. charging sets, saw benches, office telephones, Edison batteries, etc.—T. W. Thompson and Co., 1, South St., Greenwich, S.E.10. Tel.: Greenwich 1259. [7953]

**POPULAR TRANSFORMER**

Make your new set a better set with the Brownie POPULAR Transformer. Although it costs only 9/6, its purity of amplification gives a more vivid clarity of reproduction throughout the musical scale, while its sturdy British build ensures that once it is fitted the words "transformer troubles" can be eliminated from your list of worries.

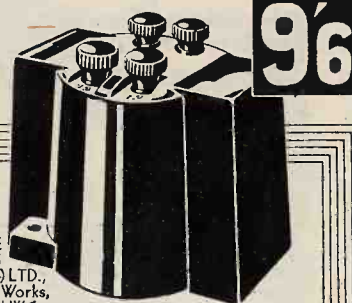

BROWNIE WIRELESS CO. (G.B.) LTD., Nelson St. Works, London, N.W.1.

**BROWNIE WIRELESS**

**CLIX 21 VARIETIES**



**No. 2 CLIX PIN TERMINAL**  
The pin with numerous uses.  
Red and Black - - - - - 2d.

The above is one of the many useful lines displayed in the Clix Showcase.

Supplied with engraved insulators



for 3d. extra. Full range of markings.

Look for the Clix Showcase on your dealer's counter. Write for descriptive leaflet

"A Matter of Connection."

**LECTRO LINX LTD.,**  
254, Vauxhall Bridge Road, S.W.1

**GRAMOPHONE PICK-UPS, ETC.**

**ELECTRIC** Pick-up, with arm, adaptable to any gramophone; pick-up 14/-, arm 7/-; c.o.d.; remarkable value.—G. Hodgson, 53, Windsor House, Victoria St., Westminster. [7738]

**R.I. Varley** and Auto Arm, 36/-, cost 98/-; Brown No. 2, with adaptor, 10/-; both in good working condition.—Atterton, jun., 6 Ramillies Rd., W.4. [7947]

**BROWN** No. 2 Pick-up and Kisha Arm, 17/6; 1 Indiograph S.M. dial, 3/-.—C. O. Pattison, 548, Shields Rd., Newcastle-on-Tyne. [7942]

**GAMBRELL** Novotone Unit; £3/15 as new.—A. Fitzbrown, Hunts Cross, Liverpool. [8017]

**IGRANIC** Phonomotor, A.C.200-240v. 50-60 cycles; £4.—Wilkinson, 89, St. John's Park, Blackheath, S.E.3. [8003]

**AMPLION** Pick-up, control, adaptor, leads, complete, as new; 25/-.—S. Doran, 3, Junction Rd., Romford. [7922]

**LOUD-SPEAKERS.**

**6-VOLT** 1/2 amp. M.O. Speaker, list £6, new last year, in perfect order, including transformer; 29/6; 7 days' approval against cash.—Brew, Pytchley, Kettering. [7845]

**200-250 Volt D.C. Mains Moving Coil** Speaker, almost new, 29/6; also Zampa double cone chassis, new, cost 32/6, 15/-; 7 days' approval against cash.—Fox, 115, Avondale Rd., Kettering. [7844]

**PERARDUA** Moving Coil Reproducers.—Cabinet models, 230-volt D.C., £5/5; 6-volt, £5; chassis only, £3/3 and £3 respectively; state output valve.—R. Vevers, 4, York Rd., Maidenhead. [7988]

**PERMANENT** Magnets for the Construction of Moving Coil Speakers, no accumulators, no mains, 35% cobalt built-up cast steel, flux density in 1 1/2 millimetre gap over 8,000 lines per square centimetre. total lines 71,500, in gap 62,000; full constructional details see "Wireless World" January 15th issue; we only stock the magnets with the highest flux density, namely, built-up type with 1 1/2 mm. gap, at the price of 4d, including screws and brass tube for coil former; prices for cradle and other parts upon application.—Supply is limited, therefore order at once from A. M. E. Sherwood, 150, King's Cross Rd., W.C.1. Phone: Clerkenwell 8882. [7955]

**NESPER** M.C. Speaker, perfect order, 6v.; 45/-.—Jones, 4, Library St., Wigan. [7937]

**GREAT Bargains.**

**GREAT Bargains.**

**GREAT Bargains.**—Epoch model A moving coil speaker kit (or complete units), brand new; a large number of these famous instruments made for a special order for use in talkies, but not executed, for credit reasons only; regular prices, £3/10, £4/2, and £5/17/6, to clear at 50/- for accumulator operation, 55/- for D.C. mains operation, 85/- for A.C. mains; kit comprising copper plated super magnet pot (weight 23 lb.), Chrystalene frame, fully adjustable, moving coil, any impedance, paper, leather and mounting rings, made up complete, if desired, 6/- extra.

**GREAT Bargains.**

**GREAT Bargains.**—In fact, the greatest bargains ever offered! A number of Epoch model A used kits at given away prices, guaranteed in perfect working order; early 1928 model, 35/-; latest model, 42/6; made up complete, if desired, 8/- extra.

**ENJOY** Marvellous Epoch Reproduction at Ridiculous Cost; don't wait until they are all gone, but secure one immediately by writing, phoning, telegraphing, or hurrying to Epoch, 3, Farringdon Av., E.C.4. [7077]

**EPOCH**

**EPOCH** Speakers by Deferred payments.

**EPOCH.**

**EPOCH** Speakers by Deferred payments.

**EPOCH**

**EPOCH** Famous Moving Coil Speakers, any type, may be obtained by any responsible householder, by easy payments; no interest, no references no red tape as simple, easy and quick as paying cash.

**EPOCH.**

**EPOCH** on the Easy.—Full particulars from Laser-son, Ltd., Gramol House, Farringdon Avenue, E.C.4. [7919]

**NIKOLA** Cones; 3/-, 3/6, 4/-, 4/6; manufacturers' N type, standardised, floating on leather.—Particulars from Knight and Co., 6, Chapel St., London, E.C.2. [8015]

**W.E. Co.** 4002 Loud-speaker, 4-pole movement, bakelite diaphragm, ebonite horn; nearest £2.—Briscoe, 8, Horsham Av., N.12. [8014]

**DOUBLE** Celluloid Cone Speaker, first class unit, in solid oak cabinet, 20x20x9, wonderful bass notes; 50/-.—Bungalow, Fairholme Rd., Burnley, Lancs. [8005]

**AMPLION** A.R.19, mahogany, good condition; £2.—Weir, 59, Risseldine Rd., S.E.23. [7990]

**MARCONIPHONE** 75 Cone Speaker, new condition; £2/5.—Jones, 3, Windermere Av., Brondesbury, N.W.6. [7987]

**MULLARD** Speaker, sound condition, £3/5 model; 30/-.—Corby, 47, Ivydale Rd., S.E.15. [7983]

Mention of "The Wireless World," when writing to advertisers, will ensure prompt attention.



**Loud-speakers.—Contd.**

**M**OVING Coil Speaker, 220v., pot low resistance coil. Bakers' make, Ferranti 25.1; 45/-.—186. Normandy Rd., Handsworth, Birmingham. [7982]  
**R**.K. Senior 230v. A.C., complete with valves and amplifier, in cabinet, cost £45, accept £20.—Apply Parry, 13, Huddersfield Rd., Barnsley. [7978]  
**C**ELESTION C14, as new; £7, bargain.—Leighton, Danehurst, Boyle Farm, Thames Ditton, Surrey. [7973]  
**G**OODMAN'S P.G.3 Cone Unit, in good order; 10/-.—Dallman, Aldbury, Tring, Herts. [7970]  
**B**AKER'S SELHURST RADIO 36-page Booklet, "Sound Advice is Yours for the Asking"; write now for new edition; see displayed advertisement on page 19. [0231]

**TRANSMITTERS.**

**C**HEBROS. Chebros. Chebros transformers and chokes of all descriptions, special transformers for transmitting and modulation; chokes a speciality; enquiries invited.—Chester Bros., 244, Dalston Lane, London, E.8. [5240]  
**E**VERSHELD 600v. D.C. Hand Generator, flawless, £4; Sullivan key, gold lacquered, silver paints, new, cost 17/6, 7/6; 0.002 glass dielectric condenser, 10,000v., 5/-; approval.—Matthews, 20, King's Rd., Chelmsford. [7948]

**VALVES.**

**A**MPLIFIER Valve.—If you require power you can not do better than one of these:—  
**F**ILAMENT Volts 6, plate volts 400 (maximum); grid bias 84 volts (approx.), impedance 800 ohms., amplification factor 3.8, mutual conductance 4.35 m.a./volts; price £5/10; see article "The Wireless World," 24th July, 1929, then send to North London Valve Co., Ltd., 22½, Casenove Rd., Stoke Newington, London, N.16. [7917]  
**A**S Specified for A.C. Kit Set; 2 M.S.4 19/6 each, M.H.L.4 12/6; guaranteed perfect, used 20 hours.—Nicholls, 57, Manworthy Rd., Brislington, Bristol. [7962]

**WIRE.**

**48** Enamelled Stocked, other fine sizes, too.—Frost, 54, Clerkenwell Rd., E.C.1. [8009]

**COMPONENTS, ETC., FOR SALE.**

**B**ELLING-LEE Panel Fittings are designed to give an expert finish to any home-constructed set; catalogue post free.—Belling and Lee, Ltd., Queensway Works, Ponders End, Middlesex. [0018]  
**P**OWER Chokes, substantially built, for smoothing circuits in eliminators dealing with currents 100-300 milliamperes, inductance 30 henries; 8/6 each; guaranteed 12 months.—Transformer Repair Co. (Dept. W), 214, High St., Colliers Wood, S.W.19. [0327]  
**W**ESTON Model 301, milliammeters, ammeters, and voltmeters, 21/- each; hot wire ammeters 0-1 amp., 4/-; 0-0.5 amp., 3/-; instrument repairs and alterations; send for list.—The Victoria Electrical Co., 17, High St., Battersea, S.W.11. Established 1910. [7565]  
**P**OTENTIAL Dividers 10,000, 15,000, 20,000, 25,000 and 30,000 ohms, 5 variable tappings; 2/- each.  
**P**OTENTIAL Dividers, heavy duty, wire wound, 15,000 and 20,000 ohms, 7 tappings, 5/6; 4 tappings, 3/9.  
**C**ONDENSERS, 2 mfd., 2/3; 4 mfd., 4/-; guaranteed; tested 500 volts.  
**C**HOKES (L.F.).—Excellent for smoothing, up to 20 milliamperes, 2/-; special heavy duty, 100 milliamperes, 8/6.  
**E**LIMINATORS, A.C., wired for half or full wave, complete with valve; £3/17/6.  
**H**.F. Chokes; 3/-.

**G**RAMOPHONE Motors, well known make, double spring, silent, complete with fittings; 30/-.  
**S**PECIAL Bargain.—B.T.H. 40 henry chokes; 9/6; any article on approval against cash.—Huggins, Radio Engineers, Clacton-on-Sea. [7398]

**600-OHMS** Decoupling Resistances; see advt. under Coils.—Groves Brothers, Manufacturers. [7751]

**B**.T.H. Pick-up and Arm, 20/-; R.I. Varley H.F. choke, 5/-; Ormond 0.0005 V condenser, 3/6; M.P.A. cone speaker unit, 7/6; Frost 200,000 ohms potentiometer, 4/6; permanent magnet M.C. speaker, 50/-; all above little used and new condition.—Box 4461, c/o The Wireless World. [7924]

**M**ORSE Tape Machine, by Siemens, in perfect condition; £3, bargain.—Brown, 5, Bain Sq., Dundee. [7932]

**R**EMOTE Control Relays, new, not ex-W.D.; send 10/- P.O., stating accumulator voltage, to F. W. Hughes, 17, Blackheath Vale, London, S.E.3. [7944]

**F**ILTERS, oak container, 200 henries choke with Stalloy core, 1 mfd. condenser, resistance, 4 terminals; 1 post free, 7/6. 12 carriage forward, 60/-.—Pianist, 20, Bond St., Ealing. [7946]

**S**ALE.—A.F.6 transformer, ratio 1-7, 22/-; wanted, any components and Wates 3 in 1 meter.—Box 4508, c/o The Wireless World. [7950]

**O**RMOND 0.0005, with 55/1 dial, new, 6/6; Sifam dual voltmeter, new, 5/6; milliammeter, 0/15, new, 5/6; 30 ohm rheostat, 1/6; 6-pin base, 1/-; 200 C.T. coil, 1/6.—Blair, 36, Hillhead St., Glasgow, W.2. [7957]

**F**OR Sale, cabinets, accessories, panels, headphones, set ready wired; inspection invited.—Write Box 4522, c/o The Wireless World. [7965]

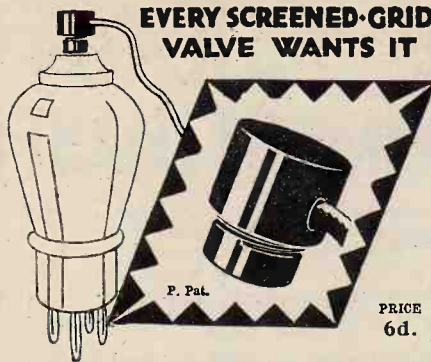

**EVERY SCREENED-GRID VALVE WANTS IT**

Just unscrew ordinary metal terminal and plug on the Belling-Lee Safety Anode Connector. A neat spring makes quick efficient contact and the whole socket is completely insulated. Even if it flicks round and touches metal screens, wiring, etc., it can't 'blow' the valves.  
 Ask your dealer, or send to us, for Belling Lee Handbook 'Radio Connections.'

**BELLING-LEE FOR EVERY RADIO CONNECTION**

Advt. of Belling & Lee, Ltd., Queensway Wks., Ponders End, Mdx.

**PAREX**

**Bakelite Drum Dials** with Escutcheons **5/6** (from stock).

Cabinets, Coils, Valve Holders, etc., for New Kilo-Mag 4 and 1930 Everyman 4.

Order direct from: **E. PAROUSSI, 10, Featherstone Buildings, High Holborn, W.C.1** Phone: Chancery 7010.

**BONA FIDE TRADERS' GUIDE.**

Send for our comprehensive Illustrated List. QUICK SERVICE. QUICK SERVICE.

**THE QUALITY HOUSE.**

PERSEUS MFG. CO., LTD. (Dept. W.W.), BRANSTONE RD., BURTON-ON-TRENT.

Order Your **1930 "EVERYMAN FOUR"** Metal Cabinet as described in "Wireless World," January 1st, 1930.



Eaton metal cabinet, with four screened compartments. Delivery from Stock, **46/6 each; Without Woodwork 35/-** Metal Cabinets for all "Wireless World" Sets in stock. Finished crystalline Brown, Black or Blue. Trade Enquiries invited. **Samuel Eaton & Sons (Manufacturers of Lighting Goods), 66/72, Barr Street, Birmingham.**

**Components, Etc., for Sale.—Contd.**

**D**ISPOSAL, Experimental Workshop, including superb lathe, furnace, valuable electric measuring apparatus, wireless materials, chemical balance, microscope, general fittings, 250 technical books, filed articles "Wireless World," "Experimental Wireless."—Greyfriars, Kingsdown, Deal. [7952]

**T**UNGSTON 100-volt H.T. Accumulator, 30/-; 8-guinea Celestion loud-speaker, £3/10; 22in. linen diaphragm and cabinet, 35/-; Kukoo cone unit, £1.—Spink, 52, Brodric Rd., Wandsworth Common. [7954]

**E**XPERIMENTER'S Surplus.—Three Pye 20H. chokes, 1 32 tapped; Lewcos coils, Q.A., Q.A.A., Q.S.P.; Ferranti A.F.5, A.F.5C; 4 Burndect anti capacity D.P. switches; Varley anti mobo R.C. coupler, type M.H.; Ormond slow motion dial; Benjamin 5-pin valve holder; Varley push-pull 2 ratio output choke; Sterling slow motion condensers, 0.0005, 0.00035; Gambrell tapped plug-in coils; McMichael neutralising condensers; Dulvolcon volume controls, etc.; write full list; all half list price.—Webb, 9, Cambridge Gardens, Seven Kings, Essex. [7961]

**R**ADIO HOUSE, Huddersfield, issues the Reliability Wireless Guide, which will be sent post free upon request by Messrs. J. H. Taylor and Co., 15, Macaulay St., Huddersfield. [7823]

**R**EGENTONE A.C. Eliminator, cost £4/19/6, £3, new; Amplion B.A.2 L.S. unit, 15/-; Westinghouse Metal rectifier, H.T.1, new, £2/15.

**R**EGENTONE Transformer to Suit, 20/-; B.T.H. pick-up and tone arm, new, 35/-; 2 J.B. drum controls, 10/- the 2, as new.—Box 4534, c/o The Wireless World. [8011]

**M**AINS Transformer, 16/6; also Westinghouse rectifier, H.T.3, 16/6; Brown's loud-speaker unit, 10/6.—95, Oswald Rd., Chorlton-cum-Hardy, Manchester. [8007]

**P**.M. 6D, 5/-; 2 P.M. 24 A, 17/- each, full emission guaranteed; R.I. Hypermu, 15/-; Telsen Ace, 5/-; Sifam m/c voltmeter, 0-6, 0-120, 10/6; Igranic metal rectifier, E.B.H., 25/-; B.T.H. pick-up, arm and volume control; 35/-—356, Caledonian Rd., N.1. [7996]  
**S**ALVAGE Stock, all sound.—6 Pye 150 H chokes, 8/- each; 4 Pye 2-5-1 transformers, 12/- each; 2 Pye tapped output transformers, 10/- each; 10-4 M.F. Hydra condensers, 500 A.C., 4/- each; 2 Ferranti 0-15 milliammeters, 20/- each; 5 Varley push-pull output transformers, 12/- each.—Franks, 42, St. George's St., London, E.1. [7981]

**T**WO Lotus 0.0005 Condensers, with drum dials, 10/6 each; Utility 0.0005 var., 5/-; Ormond drum dial, 2/6; Westinghouse H.T.3 rectifier, 15/6.—Orpin, 15, Chesterton Rd., North Kensington. [7974]

**E**XPERIMENTER'S Surplus Stock for Sale, guaranteed perfect and some not used.—R.I. Varley heavy duty power transformer, 46/-; Eureka ditto, 240 volt, 25/-; B.T.H. electric gramophone motor complete, new, 66/-; Ferranti A.F.5, 20/-; Ferranti C.P.1, 14/-; A.F.3, 17/6; A.F.3c, 19/-; 2 Cydon L.M.1, 0.0005 variable, 7/6 each; Geophone S.M. 0.0005, 10/-; 2 Hydra condensers, 4 mfd., 1,000 test, 5/6 each; T.C.C. 4 mfd., 800 test, 5/-; Everyman Four complete, less coils, £8; slow motion dials, rheostats, etc., to be cleared cheap.—Pearson, 27, Woodberry Grove, Finchley, N.12. Carriage extra. [7959]

**S**LIGHTLY Used but Guaranteed Components.—Parneco mains transformer for 240 volts 50 cycles, output 350 volts at 60 ma., for U5 valve, cost £3/5, sacrifice £1/7/6; Parneco double choke, 100 ma., £1/1, cost £2.

**J**.B. Slow Motion Variables, 0.0005, 8/-; 2 0.0003s, 7/6 each; R.I. Varley H.F. choke, 5/6; T.C.C. condensers, 800v. test, 2 6 mfd. 8/6 each, 3 2 mfd. 3/6 each.

**C**LLIMAX Potential Divider, 3/-; Lewcos 6-pin aerial coils, long and medium wave, 5/6 each; 3 Utility anti-capacity 2-pole switches, 3/- each.

**T**HREE Compartment Screwing Box and Lid, 20in. x 7in. x 6in., 10/-; polished oak cabinet, interior measurements 24x12x7, cost 50/-, £1.

**V**ALVES.—2 S625, 10/- each; P.M.6D, 5/6; P 625, 8/-; carriage extra.  
**L**OMAX, Devonshire Rd., Hasland, Chesterfield. [7967]

**A**PPLEBY'S Bargains.

**T**HE Following Slight Used Material is Offered Subject to Sale; every article will be severely tested before despatch, and guaranteed in workable condition; items are nett cash and carriage paid in Great Britain.

**R**ESIDUE of Transformers.—Ferranti A.F.5, 19/6 each; Ferranti A.F.3, Marconi Ideal, R.I. Straight Line, Mullard Permacore, Phillips, all one price, 14/- each, limited number.

**R**ESIDUE of Pick-ups.—Woodroffe, 45/-, 35/- and R 25/- each; R.I. Varley, 25/-, 20/- each; Brown, best model 45/-, 30/- each, prices depending upon condition; smaller Brown, Igranic Phonovox, Amplion Vivavox, G.E.C., Burndect, all one price, 14/- each, limited number; Blue Spot and arm, 27/6; B.T.H. and arm (straight), 32/-; arms, Raytrak, 19/6; Watmel, 4/9.

**N**OW.—Send now; many clients were disappointed by material having been sold previous to their application for goods lately.

**A**PPLEBY'S, Number Forty-four, Chapel St., Marylebone, N.W.1 (4 minutes from Oxford St., London). [0316]

**Y**OUR Old Components Taken in Part Payment for Latest Type; see our advert. in column Receivers for Sale.—Scientific Development Co., 51, Fishergate, Preston. [0228]

Mention of "The Wireless World," when writing to advertisers, will ensure prompt attention.

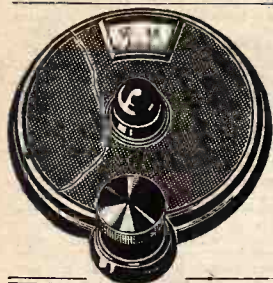

**BABY JUNIOR**  
2 1/2" - 2/4

**BABY**  
3" - 2/6

**STANDARD**  
4" - 2/9

In Black or Brown.

# "ISO" DIALS

"Iso" Dials have a definite grip. They do not slip.

**ISOMONA 70 PRECISION**  
SIZE PRICE  
3" 4/-

**HAW & Co. Ltd.**  
20, CHEAPSIDE,  
London, E.C.2.  
Tele.—CITY 9510.  
Sole Distributors for  
"Iso" Products,  
Cone Units, Trans-  
formers, Chokes,  
Condensers, Trickle  
Chargers, Elimina-  
tors, etc.

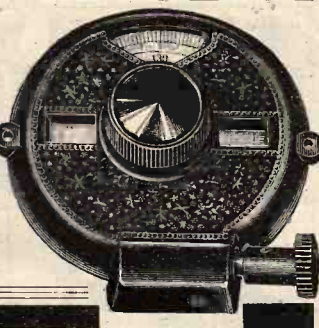

## Permanent Magnets for Construction of Moving Coil Loudspeakers.

As specified in "Wireless World," Jan. 15th.



**£4.0.0**

including cylinder for coil former and screws.  
In 35% Cobalt Steel, 8,000 lines per square cm. in 1 1/2 mm. gap.  
Cradle and other parts necessary to complete Loudspeaker, £1 extra.

**A. M. E. SHERWOOD,**  
150, King's Cross Rd., London, W.C.1.  
Phone: Clerkenwell 8832.

### Components, Etc., for Sale.—Contd.

**TITAN** Coil, new, 9/-; Blue Spot, adjustable, unused, 17/6; Minor chassis, 8/6; 75-henry choke, 40 ma., new, 12/6; 2 Utility drum dial, 0.0005, unused, 7/3; 2 sets McMichael transformers, 80-7000 meters hardly used £2 lot or 4/- each; numerous other components both used and new, lists on request.—Heaton, 42, Green Lane, Thornton Heath, Surrey. [7993]

**A RADIO-GRAMOPHONE Manufacturing Company** in voluntary liquidation.—Parts offered for sale by Order of the Liquidator: Fixed condensers: Dubilier 0.001, 0.002, 0.005, 0.0005, 0.0003, each 6d. Variable condensers: Burton 0.0005 and 0.00025, 2/- and 1/6; Ormond 0.0005, 5/-; pair of Cylon 0.0005, drum control, 9/-; Formo 0.0005, 2/-; Brandes 0.0005, 5/-; Chokes: H.F. Varley, Climax, Watmel, Woodfull and Dubilier, 3/6, 3/-, 9d., 6d. and 1/9 respectively. Coils: Cosmos A.N.P. coils, 2/6; British General, 2/6. Dials: Igranite Indigraph and Kurz-Kasch, 2/- each. Eliminators: Marconiphone D.C.2, 15/-; Cosmos L.F., 10/-; Benjamin A.C., 30/-; and R.I. Varley A.C., 30/-; Mullard grid leaks: 0.1, 0.25, 0.5, 1 and 5 meg., each 3d.; Garrard double and single spring motors, 17/6 and 12/6 respectively. Pick-ups: Detex, Loewe, Burdett and Varley, 3/6, 5/-, 9/-, and 12/6 respectively. Resistances: 100,000 ohms anode, 9d. Switches: Wearite D.P.D.T., push-pull, 1/-; Lotus D.P.D.T., push-pull, 1/-; Wearite 2-4 and 8-pole lever, 1/9 and 2/6 respectively. Transformers: Telsen Ace, 2/-; Ferranti O.P.6C, O.P.4C, and A.F.5C, 5/-, 12/6 and 15/- respectively; G.E.C. 4:1, 7/6; Met-Vick mains filament transformer, 7/6; Marconiphone, model C, 10/-; McMichael, Nos. 1 and 3, semi-periodic, 1/- each; various tone arms, 1/6; Watmel pick-up arm, 2/-; R.C. Units: Polar and Cosmos, 1/6 and 3/-; Marconiphone volume controls, 2/-; Valve holders: Precision and Igranite, 6d.; Alpha and Oson, 3d. Carter potentiometers, 3, 10, 30 and 400 ohms, 1/3 each; Detex portable turntable, 2/-; Valves: Ostram, D.E.H.410, D.E.L.410, D.E.5A, D.E.5B, D.E.8 H.F., H.L.8, H.8 and P.8, each 5/-; M.S.4 and S.8, 10/-; Mullard, P.M.1 H.F., P.M.1 L.F., P.M.2, P.M.3, P.M.6, each 5/-; P.M.22, P.M.24, and P.M.26, each 10/-; Six-Sixty, S.S.10, S.S.2a L.F., S.S.2a H.F., S.S.6075, each 3/6; Cosor 410 R.C. and 610 P, each 4/-; Ediswan 5E225, 10/-; Mazda B11, 5/-; Loudspeakers: Mullard P.M., 12/6; National Cone, 5/-; Six-Sixty cone, 5/-; Magnavox moving coil, D180, R5, and D7, 70/-; corner fittings for loudspeakers, in mahogany and oak, opening and closing cabinets, polished, 30/- each. See display advertisement in these pages.—Liquidator, Reproduction, Ltd. (in Voluntary Liquidation), 5, Dysart St., Wilson St., E.C.2. [8019]

### MISCELLANEOUS.

**ALEXANDER BLACK**

PLEASE Note New Address.

**THE Original Wireless Doctor**, will call (London and Home Counties) and cure your set.

**CONSULTATIONS** by Appointment Without Obligation, sets installed, maintained, and brought up to date, gramophone pick-ups, eliminators, and Watson moving coil speakers demonstrated; purity reproduction specialist.

55, Ebury St., Victoria, S.W.1. Sloano 1655. [0277]

EASY Payments—We supply, by easy payments,

**TRANSFORMER REPAIR CO.,**

Dept. W.,

214, High Street, Colliers Wood, London, S.W.19

## The "Utility"

—THE BEST VALUE

Ask your local Dealer to show you this condenser. It has a capacity of well built and well finished, and absolutely smooth reaction at all p scale. Put the best into your set get the best results—always ask for the *Guaranteed* Wireless Compon

**WILKINS & WRIGHT**

HOLYHEAD? *Utility* BIRMINGHAM

# 100%

That sums up the **TRIX** Fixed Condenser in the briefest manner! Hundred-per-cent! Throughout and right down to the brass terminals—hundred-per-cent! 100% real ruby mica insulation, 100% genuine **COPPER** Foil, 100% Trixite moulded casing. And 100% performance every time! You'll appreciate this fine component, not merely because it is low in price but because it is so high in quality.

## TRIX FIXED CONDENSERS

PRICES FROM  
**1/-** EACH

**ERIC J. LEVER (TRIX) LTD.,**  
8-9, Clerkenwell Green,  
London, E.C.1.

Phone: Clerkenwell 3014/5.



## THE PILOT SWITCH

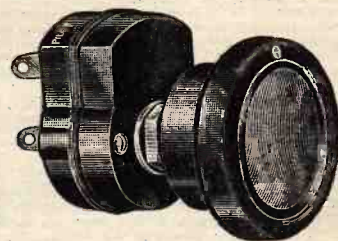

A Power Switch for all uses, Mains Sets, Eliminators, etc. Handles 3 amperes at 220 volts. Supplied with black or brown Bakelite knob, or with lever and "on and off" plate.

Retail Price 2/6

**USE PILOT COMPONENTS**

Write for Catalogues to:—

**THOMAS A. ROWLEY, LTD.,**  
59 Skinner Lane, Birmingham.

Sole Agents for Great Britain and Ireland for all lines manufactured by The Pilot Radio & Tube Corporation of New York.

West of England Distributors:—F. BURRIS & SONS, 7 to 16, Redcliffe Street, Bristol.

**Repairs.—Contd.**

**TWELVE Months' Guarantee** Accompanies all our Repairs. Any make of L.F. transformer, head-phones, or loud-speaker repaired and despatched within 48 hours; 4/- post free; don't discard if burnt out; terms to trade.—Transformer Repair Co., (Dept. W.), 214, High St., Colliers Wood, S.W.19. [0011]

**WANTED.**

**WANTED.** 210 A.C. Megavox eliminator, also trickle charger.—Newman, 15, Lancaster Rd., N.W.3. [7958]

"W.W." Record III, or cabinet and parts for same.—W. 1, Eversfield Rd., Kew Gardens. Phone: Richmond 2035. [7940]

**WANTED,** rotary converter, 30-50 volts D.C. to 300-400 volts D.C. output, 150 milliamp.—Box 4535, c/o *The Wireless World*. [8006]

**FERRANTI** Exponential Speaker, Amplion Lion chassis, Marconiphone 6-1 or 6-1 Ideal transformer, exchange for above, or sell 2 A.15 frame aerials, H. and L. wave, Fellow A.C. charger, P.M.12, P.M.24, unused, 2 Ormond drum dials.—Brierton, 100, Temple Rd., Willenhall, Staffs. [7984]

**EXCHANGE.**

**YOUR** Old Apparatus Taken in Part Payment for Latest Type; see our advert. in column Receivers for Sale.—Scientific Development Co., 51, Fishergate, Preston. [0230]

**FINANCIAL PARTNERSHIPS.**

**WELL** Established and Successful Radio Accessory Manufacturer in London has a vacancy for a partner with capital up to £1,000; meeting by appointment.—Box 4521, c/o *The Wireless World*. [7964]

**SITUATIONS VACANT.**

**RADIO** Operators Required, with first class installation and maintenance experience in C.W. and preferably short wave work; applicants to give full information in the following order: (1) Name, age, qualifications, etc. (2) details C.W. experience, (3) short wave experience.—Write in confidence to T., Box 4509, c/o *The Wireless World*. [7951]

**WELL** Educated Junior Assistant for Radio Laboratory, north of London, capable of taking measurements, calculating results, and typing own records; general scientific and engineering knowledge, musical ear desirable.—Full details to Box 4524, c/o *The Wireless World*. [7966]

**IMPROVER** Wanted, with knowledge of set designing and practical experience in component manufacture; able to turn and keep drilling machines, etc., in workshop in repair; S.E. district; state salary.—Box 4463, c/o *The Wireless World*. [7926]

**RADIO** Mechanic Required, must possess advanced practical and theoretical knowledge and be businesslike and efficient worker; state age, salary, and experience.—Box 4483, c/o *The Wireless World*. [7934]

**YOUNG** Man Required, qualified to be technical assistant in the main receiver department of a Sheffield wireless manufacturer.

**DO NOT** Apply Unless You Are Fully Qualified, by present or past experience and training, to make a success of the position offered.—Box 4529, c/o *The Wireless World*. [7997]

**REPRESENTATIVES** (whole time) Wanted for Wireless Components and Sets (only those with first class wireless sales experience entertained); appointments to be on salary basis plus commission.—Apply, with full details regarding wireless sales experience, whether you can drive a car, minimum remuneration required, age, and which territory preferred or where best known, Box 4530, c/o *The Wireless World*. [7998]

**SERVICE** Engineer Required by Leading Radio Manufacturers, with knowledge of modern instruments, including mains apparatus.—Write, stating age, qualifications, and salary required, to Box 4537, c/o *The Wireless World*. [8002]

**SEVERAL** Vacancies Exist for Young Men, aged 21-26, who have a good theoretical knowledge of electrical engineering (light current), preference given to those who have taken a course at some recognised technical college, good prospects for successful candidates.—Call, or write, stating age and full details of training or experience to Standard Telephones and Cables, Ltd., Employment Dept., Aerodrome Rd., Colindale, N.W.9. [7979]

**SALESMAN** and Service Manager Required for Prominent Music House in Glasgow, must be thoroughly capable, of good presence, and with up-to-date knowledge of installation and trouble tracing in modern mains operated screened grid radio gramophones and receivers.—Apply (in writing only) in first instance, to J. M., c/o Charles McDowall, Advertising, 50, Wellington St., Glasgow, O.2. [7969]

**JUNIOR** Technical Correspondent Required by Service Department of Well Established Wireless Manufacturers, 20 miles from London, principal work consists of solving difficulties encountered by home constructors by correspondence.—Write, giving full details, age, salary required and experience, if any, to Box 550, c/o Pool's Advertising Service, 180, Fleet St., E.C.4. [8018]

**SITUATIONS WANTED.**

**YOUNG** Man, 28, first class P.M.G., 3 years' sea experience, and previously 8 years' accountancy, good knowledge wireless, seeks situation, any kind.—Box 4531, c/o *The Wireless World*. [7999]

**MAN**, 21, seeks position laboratory assistant, sound knowledge radio, neat bench worker, D.O. experience, references.—Box 4541, c/o *The Wireless World*. [8013]

**"RHAPSODY=TWIN" RADIO-GRAMOPHONE CABINETS**

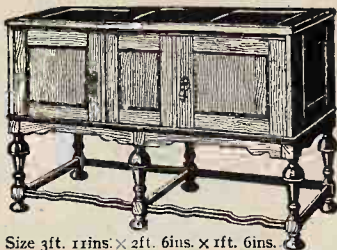

Size 3ft. 11ins. x 2ft. 6ins. x 1ft. 6ins.

Finest Quality, 3 doors in front, 3 on top. Centre compartment for Loud Speaker. Figured OAK **69/6** Polished, Four Guineas. Packing 5/- Free on Rail.

Walnut **£5.15**, polished.

**THE LIQUIDART, REPRODUCTION LTD., 5, DYSART ST., E.C.2.**

Also the following completed "Mains" models:—"Full Grand" (list £136.10), **£58.** "Salon Grand" (list £105), **£45.**

Separate Components, see line insertion these pages.

**PORTSMOUTH MUNICIPAL COLLEGE.**

Principal: L. B. Benny, M.A.

**ELECTRICAL ENGINEERING DEPARTMENT.** Radio Telegraphy Section.

Required **IMMEDIATELY**, a Full-Time Lecturer to take charge of the Training of Wireless Operators for the Postmaster-General's certificate. The work has been carried on for many years, and includes both full-time day and part-time evening courses.

Salary on the scale £186-12-£384, according to experience, subject to deduction of 5% under Teachers' Superannuation Act.

Application should be made, without delay, to the undersigned, giving earliest date at which duties can be entered upon. No form of application is prescribed.

H. E. CURTIS, Secretary.

Offices for Higher Education, The Municipal College, Portsmouth.

**THE QUALITY HOUSE.**

**PERSEUS MFG. CO., LTD. (Dept. W.W.), BRANSTONE RD., BURTON-ON-TRENT.**

Order Your **1930 "EVERYMAN FOUR"** Metal Cabinet as described in "Wireless World," January 1st, 1930.



Eaton metal cabinet, with four screened compartments. Delivery from Stock, **46/6** each; Without Woodwork **35/-** Metal Cabinets for all "Wireless World" Sets in stock. Finished crystalline Brown, Black or Blue. Trade Enquiries invited. Samuel Eaton & Sons (Manufacturers of Lighting Goods), 66/72, Barr Street, Birmingham.

**Situations Wanted.—Contd.**

**B.Sc. (28)**, 5 years' experience, mainly research, transmission and reception, experienced studio technique and land line transmissions, requires situation, research preferred.—Box 4536, c/o *The Wireless World*. [8001]

**YOUNG** Man, 22, first class P.M.G. certificate, experience electrical and mechanical engineering, amplifier work, seeks situation with wireless, valve, gramophone, or sound picture firm; fluent German; references.—Box 4540, c/o *The Wireless World*. [8012]

**BOOKS, INSTRUCTION, ETC.**

**WET** H.T. Batteries are now a proved success; write for new illustrated booklet, giving cost and method of building and maintaining free; mention paper.—Taylor, 57, Studley Rd., Stockwell, London. [0077]

**STEP** by Step Wireless; a complete course of the theory of electricity in relation to the practical design of wireless apparatus, eliminators, circuits, etc., with extracts from a designer's notebook, giving up-to-date practical application; issued weekly; send 1/- p.o. for first 4 weeks.—Clifford Pressland, A.M.I.E.E. Eng., Dept. W.W., Hampton-on-Thames. [0195]

**FREE:** Inventor's Guide on Patents.—T. A. A., 253 (W.) Gray's Inn Rd., London, W.C.1. [6373]

**AN** Introduction to Wireless Telegraphy and Telephony, by Professor J. A. Fleming, M.A., D.Sc.—An interesting account of the principles of wireless telegraphy and telephony for the listener-in and wireless experimenter; 3/6 net, of booksellers, or Pitman's, Parker St., Kingsway, London, W.C.2. [7071]

**"WIRELESS WORLD"** 1927-28-29; any offers.—Forrest, 1, Mount Av., Eccleshill, Bradford. [7991]

**THE LAST WORD IN SAFETY**



Fit the new Belling Lee Fuse to Belling Lee Wander Plugs, Spade or Pin Terminals, or Plugs and Sockets, and give utmost safety to your valves and Components.

Showing the Belling Lee Fuse fitted in a Belling Lee Wander Plug. Price complete 1/4

Fuse, with adaptor Price 1/- Spare Fuse 6d.

Ask your dealer, or send to us, for Belling Lee Handbook, "Radio Connections."

**BELLING-LEE FOR EVERY RADIO CONNECTION**

Advt. of Belling & Lee, Ltd., Queensway Works, Ponders End, Middx.



**EVERY RADIO ENTHUSIAST SHOULD SEND FOR IT!** Send 3d. in stamps for this 56-page Catalogue. Scores of Ready-to-assemble Wireless Cabinets and Special Osborn Offers.

**CHAS. A. OSBORN** (Dept. W.W.), The Regent Works, Arlington Street, London, N.1. Telephone: Clerkenwell 6095. Open to 7.30 p.m. Saturdays 4.30 p.m. And at 21, ESSEX ROAD, ISLINGTON, N.1. Open until 9 p.m. 9 p.m. SATURDAYS. Phone: Clerkenwell 5634.

- FOREIGN LISTENERS 4 Set of 6 Coils . . . 37/6
  - SCREENING BOXES . . . 5/- each; 19/- set.
  - RECORD III Coils 35/- set. KIL0-MAG 4 Coils 33/- set.
  - 1930 EVERYMAN Coils. 42/6 set. METAL BOXES—
  - 4 Compartments . . . 32/6 Complete Cabinets . . . 45/-
  - W.W. KIT SET Coils and Switches, mounted . . . 37/6
  - Metal Boxes . . . 27/6 Complete Cabinets . . . 35/-
  - S.G. Short Wave 3 Set 4 Coils . . . 20/-
- SEND ALL YOUR ENQUIRIES. TRADE SUPPLIED. A. T. STOTT, 1a, Duke St., ROCHDALE. (Late 63, Syke Road.)

Mention of "The Wireless"

World," when writing to advertisers, will

ensure prompt attention.

# Centralab

Control is everything



Our 1930 4th Edition of the "Great Voice" booklet tells you all about Centralab Volume Controls and their uses. This 68-page booklet contains numerous diagrams and information of paramount importance to all constructors of radio sets, gramophones, etc. Send 6d. in stamps for postage.

Your radio or electrical gramophone must carry on every time you snap on the switch. Your volume control must function smoothly, easily—consistently if you wish to be rewarded with perfect reproduction. No radio is perfect unless it is Centralab equipped. Centralab Modulators and Potentiometers are used as standard by all the leading manufacturers—this is an insurance of supreme quality.

POTENTIOMETERS.		
Type P. 109	0-200	ohms.
" P. 110	0-400	"
" P. 111	0-2,000	"
" P. 112	0-10,000	"
" P. 050	0-50,000	"
" P. 100	0-100,000	"
MODULATORS.		
" M. 250	0-250,000	"
" M. 500	0-500,000	"

All 10/6 each.

**THE ROTHERMEL CORPORATION LTD.,**  
24, Maddox Street, London, W.1.

Phone: MAYFAIR 0578/9.

Fit the  
**DUBILIER**  
long-life  
**BATTERY**

66 Volts  
**7/9**

BRITISH MADE

and improve  
the quality  
of your  
reception

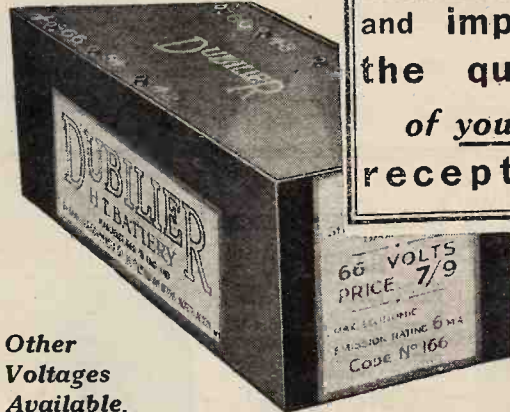

Other  
Voltages  
Available.

Ask your dealer for a copy of the Dubilier Booklet — "A Bit about a Battery."

Dubilier Condenser Co. (1925), Ltd., Ducon Works, Victoria Road, North Acton, London, W.3.

Oliver B21

Electrically sealed  
**METAL CABINETS**  
Complete with Base for 1930 Everyman Four, New Kilomag Four, and W.W. Record III. Jacobean Finish.  
TERMS: CASH WITH ORDER Price 57/6.  
**RIGBY & WOOLFENDEN,** SHEET METAL WORKERS,  
MILNROW RD., ROCHDALE.

**REPAIRS**  
Any make of L.F. Transformer, Loudspeaker or headphones repaired and dispatched within 48 HOURS—TWELVE MONTHS' GUARANTEE with each repair. 4/- Post Free.  
Terms to Trade.  
**TRANSFORMER REPAIR CO.,**  
Dept. W.,  
214, High Street, Colliers Wood, London, S.W.19

**BERCLIF**  
"EVERYMAN FOUR" CONVERSION  
L.W. COILS AND BASES ... 34/6  
CONVERSION S.W. COILS ... 10/6  
Particulars and detail prices post free. TRADE SUPPLIED.  
**SIMMONDS BROS.,**  
SHIRELAND ROAD, SMETHWICK.



PRICE  
**6'6**

## The "Utility" Differential

—THE BEST VALUE IN ITS CLASS

Ask your local Dealer to show you this "Utility" condenser. It has a capacity of .0001 mfd., is well built and well finished, and it provides absolutely smooth reaction at all points of the scale. Put the *best* into your set and you'll get the *best* results—always ask for "Utility" the *Guaranteed* Wireless Components.

**WILKINS & WRIGHT LTD**  
HOLYHEAD? *Utility* BIRMINGHAM

**WRITE FOR THE "Utility" LIST POST FREE**



**INDEX TO ADVERTISEMENTS.**

	PAGE		PAGE		PAGE
Adolph, Fredk.	19	Haw & Co., Ltd.	21	Rigby & Woolfenden	23
Appleby, E. Hetherington	16	Hayberd, F. C. & Co.	24	Rothermel Corporation, Ltd. (Centralab)	23
B. & J. Wireless Co.	16	Holzman, L.	8	Rowley, Thomas A., Ltd.	21
Baker's "Selhurst" Radio	19	Hughes, F. A. & Co., Ltd.	Cover iii. & 7	Sheffield Magnet Co.	10
Bayliss, Wm., Ltd.	Cover iii. & 2	Igranic Electric Co., Ltd.	9	Sherwood, A. M. E.	21
Beiling & Lee, Ltd.	20 & 22	Lectro Linx, Ltd.	18	Siemens Bros. & Co., Ltd.	14
British Ebonite Co., Ltd.	24	Lever, Eric J. (Trix), Ltd.	21	Sifam Electrical Instrument Co., Ltd.	19
British Institute of Eng. Tech.	Cover iii.	Lisenin Wireless Co.	24	Simmonds Bros.	23
British Insulated Cables, Ltd.	7	Lyons, Claude, Ltd.	16	Stott, A. T.	22
Brownie Wireless Co. (G. B.), Ltd.	18	Marconiphone Co., Ltd.	15	Stratton & Co., Ltd.	2
Burton, C. F. & H.	Cover i.	McMichael, L., Ltd.	Cover i.	Telegraph Condenser Co., Ltd.	10
Cossor, A. C., Ltd.	12	M-L Magneto Synd., Ltd.	11	Telsen Electric Co., Ltd.	Cover i.
Dubilier Condenser Co. (1925), Ltd.	4 & 23	Mullard Wireless Service Co., Ltd.	Cover iv.	Thomas, Bertram	8
Eaton, S., & Sons	20	O'Brien, Thos., Ltd.	16	Transformer Repair Co.	23
Electradix Radios	8	Osborn, Chas. A.	22	Trellehorgs Ebonite Works, Ltd.	22
Epoch Radio Manf. Co., Ltd.	17	Paroussi, E.	20	Tudor Accumulator Co., Ltd.	2
Ever Ready Co. (G.B.), Ltd.	Cover ii.	Perseus Radio Manf. Co.	20	Tulsemere Manf. Co.	24
Ferranti, Ltd.	1	Perrix, Ltd.	2	Ultra Electric Co., Ltd.	Cover i.
Forno Co.	6	Portsmouth Municipal College	5	Westinghouse Brake & Saxby Signal Co. Ltd.	6
General Electric Co., Ltd.	3	Radiogramophone Development Co.	4	Weston Electrical Instrument Co., Ltd.	11
Gilbert, J. C.	24	Regent Radio Supply Co.	6	Wilkins & Wright, Ltd.	23
Gilman, J. S. & Co.	24	Reproduction, Ltd.	22	Wingrove & Rogers, Ltd.	5
Graham Amplion, Ltd.	13				
Grosvenor Battery Co., Ltd.	9				





**HAVE YOU ELECTRIC LIGHT?**

Tannoy mains units act like the electric light, no moving parts or valves to break, simply connect to your present set and "switch on." They are **always constant**, providing more volume. No more expense of renewals... no more batteries running down... perfect H.T. and L.T. for ever.



H.T. from £2-17-6 (complete)



L.T. from £2-12-6 (complete)

**Mains Units** THE TULSEMERE MFG. CO.  
1-7, DALTON STREET, WEST NORWOOD, S.E.27.  
Telephone: Streatham 6731.

**BE SURE OF YOUR PANEL**



**EBONITE IS GENUINE**

Tested to 104,000 volts.  
USE THE PRIZE WINNING LOW LOSS FORMER.

LOOK FOR TRADE MARK.

Write for Handbook on Windings and Circuits, Post Free 4d.  
THE BRITISH EBONITE CO., LTD., HANWELL, LONDON, W.7.

High-grade  
**QUEEN ANNE STYLE FIGURED OAK CABINET**

Height 3ft. 3ins. Depth 1ft. 3ins.  
For Panels up to 21 ins. x 7 ins.  
Baseboards up to 11 ins.

**£5.5.0**  
Carriage Paid.

Prices of other sizes in proportion.  
Manufacturer of all types of wireless cabinets and furniture of every description. Illustrated lists free.



**GILBERT, CABINET MAKER, SWINDON.**  
Estimates Free. Estd. 1866.

**GILMAN THE LOUDSPEAKER CHASSIS**



A completely assembled cone floated on felt in a highly polished aluminium casting. It incorporates our NEW adjustable unit fixing plate, ensuring the correct centering of the unit reed in cone. **EXCLUSIVE TO GILMAN CHASSIS.** Plates can be supplied to fit any make of unit in the World.  
Power Model, 18" 22/6

Ask for a GILMAN chassis!  
If your dealer cannot supply write direct to:  
**J. S. GILMAN & CO.,**  
63, Basinghall Street, London, E.C.2.  
Phone: Metropolitan 9892.



**HEYBERD ELIMINATOR COMPONENTS**

Immediate delivery from stock of Heyberd mains transformers, filter chokes, metal rectifiers, condensers, rectifier valves, and resistances.

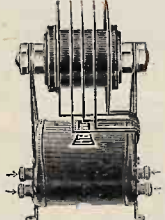



*Lists and diagrams free.*

**F. C. HEYBERD & CO., 10, Finsbury St., E.C.2.**

**LISENIN POSITIVE GRIP TERMINALS**

(Patent 245,586)

Maintain their lead established five years since, and are acclaimed by the keen Radio experimenter as the ideal terminal. There is one for all radio connections. Write for descriptive leaflet. It's sent free to all "W.W." readers.





Plugs and Sockets with 2 nuts..... 4d.  
Spade Ends..... 5d.  
Standard Wander Plugs..... 2d.  
Chubby Wander Plugs, for portable sets..... 2d.  
Pin Ends..... 2d.  
All Mains Socket and Plug..... 6d.

Don't forget Pos. Grips overcome unsightly frayed ends to leads. What a boon!  
**THE LISENIN WIRELESS COMPANY, SLOUGH, BUCKS.**

Mention of "The Wireless World," when writing to advertisers, will ensure prompt attention.

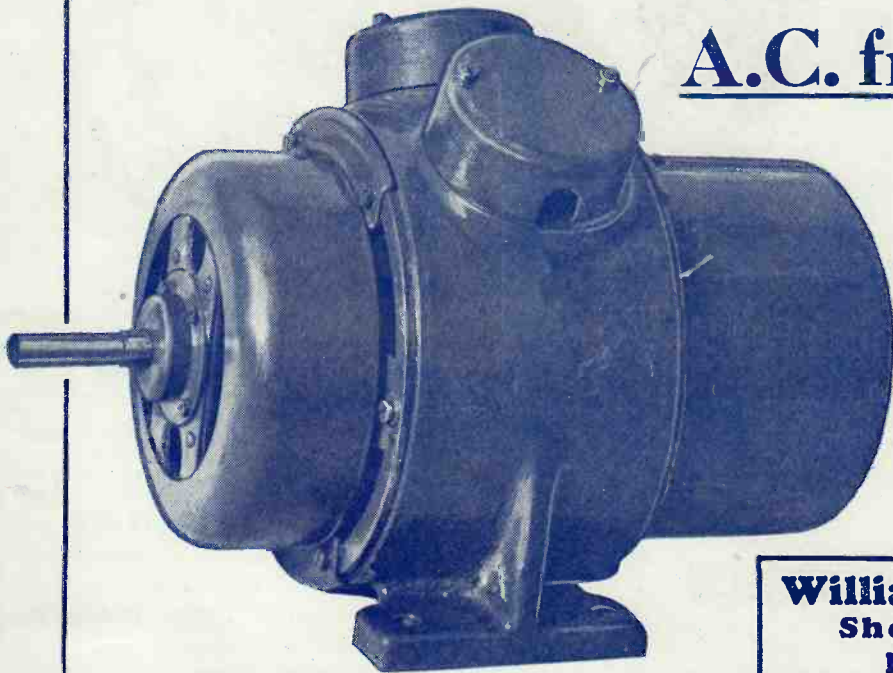
**BAYLISS ROTARY CONVERTER**



**A.C. from D.C.**

**Load 400 Watts.**

ANY Input.  
ANY Output.

PRICE

**£12. 10. 0**

Delivery  
from Stock.

**William Bayliss Ltd.**  
**Sheepcote Street**  
**BIRMINGHAM**

Telephone:  
Mid 1409.

Telegrams:  
"Drawbench, B'ham."

**ENGINEERS!**



**Can't we get together?**

All we ask is the chance to prove that you can earn £300, £400, £500 per year or more. Other men are doing it, and you can do the same.

We have an unrivalled and world-wide organisation, waiting to help you whether you be novice or expert. If you wish for something more than a "bread and butter" job you owe it to yourself to investigate our Service.

Our handbook "Engineering Opportunities" has pointed the way to better things to over 20,000 of your fellows. It contains details of A.M.I.Mech.E., A.M.I.E.E., A.M.I.C.E., A.M.I.A.E., A.M.I.Struct.E., London Matric., C. & G., G.P.O., etc., Exams., outlines home study courses in all branches of Electrical, Mechanical, Motor and Wireless Engineering, and explains our unique guarantee of

Write for this Book today  
**IT'S FREE!**

**NO PASS—NO FEE.**

In a Brilliant Foreword Prof. A. M. Low shows clearly the chances you are missing.

"Engineering Opportunities" and our advice are quite FREE. Don't neglect this offer—give vent to that "upward urge" and send a postcard NOW, stating Branch, Post or Exam. which interests you.

**BRITISH INSTITUTE OF ENGINEERING TECHNOLOGY,**  
387, SHAKESPEARE HOUSE, 29-31, OXFORD STREET, W.1.



**3 REASONS**

Wireless constructors prefer a Trolitax panel because

1. Trolitax gives perfect insulation.
2. Trolitax can be relied upon in all circumstances.
3. Trolitax offers a choice of handsome designs including some new wood finishes.

Ask to see the new screened panel. Trolitax with a metal back sprayed on—something entirely new!

**TROLITAX**

**F. A. HUGHES & CO., LIMITED,**  
204-6, Great Portland St., London, W.1. Phone: Museum 8630 (4 lines).

Distributors for Northern England, Scotland and North Wales:  
H. C. Rawson (Sheffield and London) Ltd., 100, London Road, Sheffield. Phone: Sheffield 26006. 22, St. Mary's Parsonage, Manchester. Phone: Manchester City 3329.

Advertisements for "The Wireless World" are only accepted from firms we believe to be thoroughly reliable.

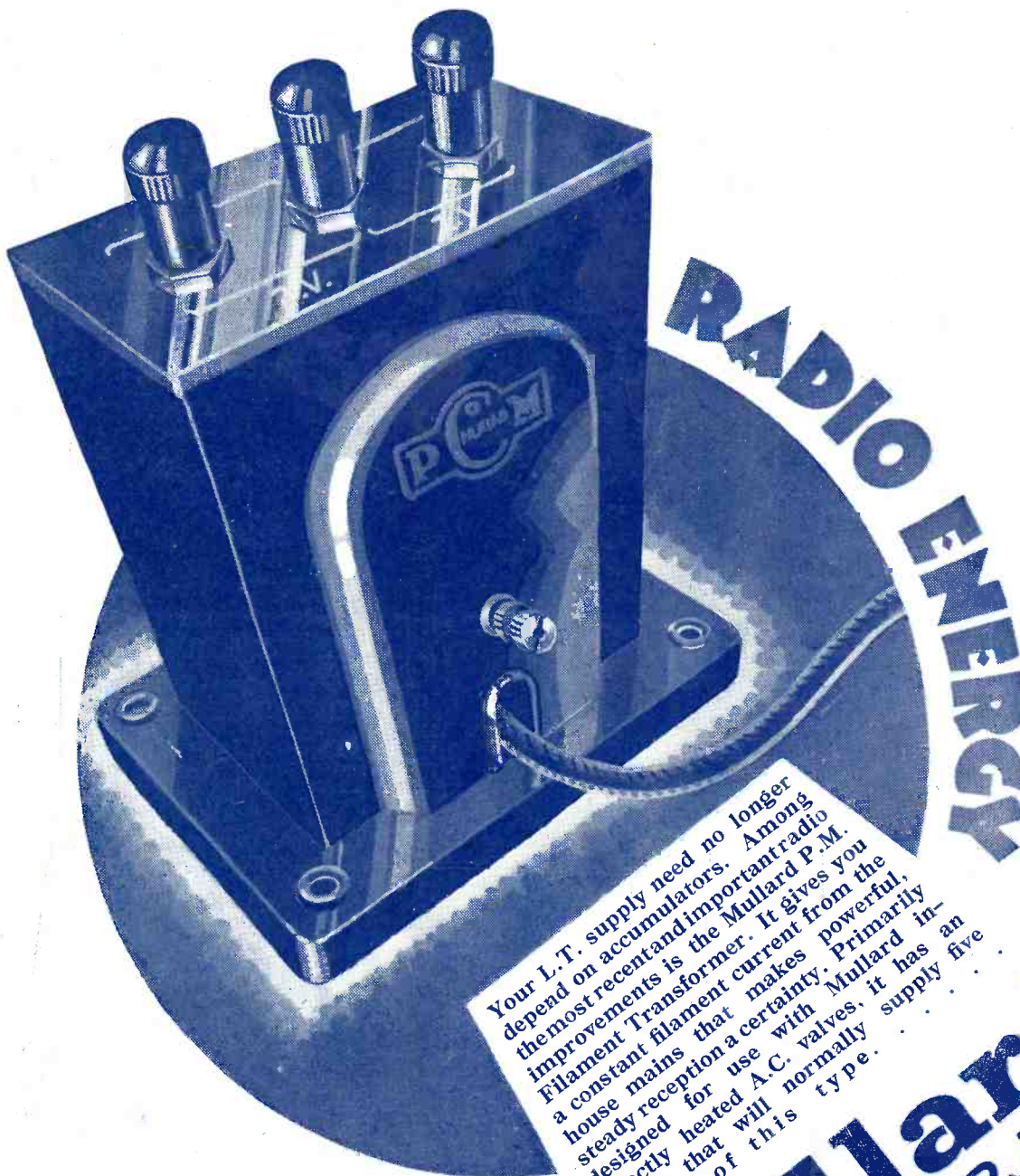

Your L.T. supply need no longer depend on accumulators. Among the most recent and important radio improvements is the Mullard P.M. Filament Transformer. It gives you a constant filament current from the house mains that makes powerful, steady reception a certainty. Primarily designed for use with Mullard indirectly heated A.C. valves, it has an output that will normally supply five valves of this type.

# Mullard MASTER RADIO

Advt. The Mullard Wireless Service Co., Ltd., Mullard House, Charing Cross Road, London, W.C.2.

Printed for the Publishers, ILLIFFE & SONS LTD., Dorset House, Tudor Street, London, E.C.4, by The Cornwall Press Ltd., Paris Garden, Stamford Street, London, S.E.1.

Colonial and Foreign Agents:  
 UNITED STATES—The International News Co., 131, Varick Street, New York. FRANCE—W. H. Smith & Son, 248, Rue Rivoli, Paris; Hachette et Cie, Rue Réaumur, Paris.  
 BELGIUM—W. H. Smith & Son, 78, Marche aux Herbes, Brussels. INDIA—A. H. Wheeler & Co., Bombay, Allahabad and Calcutta. SOUTH AFRICA—Central News Agency Ltd.  
 AUSTRALIA—Gordon & Gotch, Ltd., Melbourne (Victoria), Sydney (N.S.W.), Brisbane (Queensland), Adelaide (S.A.), Perth (W.A.), and Launceston (Tasmania).  
 CANADA—The American News Co., Ltd., Toronto, Winnipeg, Vancouver, Montreal, Ottawa, St. John, Halifax, Hamilton; Gordon & Gotch, Ltd., Toronto; Imperial News Co. Toronto, Montreal, Winnipeg, Vancouver, Victoria. NEW ZEALAND—Gordon & Gotch, Ltd., Wellington, Auckland, Christchurch and Dunedin.

SIZE VERSUS EFFICIENCY OF COILS

# The Wireless World

AND RADIO REVIEW

4<sup>D</sup>

*The Paper for Every Wireless Amateur*

Wednesday, January 29th, 1930.

**Mullard**  
THE-MASTER-VALVE

for  
**TONE  
VOLUME  
DISTANCE**

**"Ekco-Lectrify"**  
your radio  
with an

**66 EKCO**

**Power Supply Unit**

Write for Free Booklet on "All-Electric Radio" to:  
E. K. COLE, Ltd., Dept. W, "EKCO" Works, Leigh-on-Sea.

**Utility DIFFERENTIAL CONDENSER**

Stocked by all good dealers and the best value in a Condenser of this type that you can possibly obtain. The capacity is .0001 mfd. and the design provides smooth reaction at all points of the scale. Fully guaranteed for efficiency and finish by "Utility" — makers of the Dials, Condensers and Switches that experienced constructors always choose. Illustrated list free for a p.c.

Other Prices	.00015	7/-
	.0002	7/6
	.0003	9/6

**6/6**

**WILKINS & WRIGHT LTD.,**  
"Utility" Works,  
Holyhead Road, BIRMINGHAM.

*Green for Safety!*

**T.C.C. CONDENSERS**

Adv. Telegraph Condenser Co. Ltd.,  
Wales Farm Rd., N. Acton, London, W.3.

3375

**Cut-out  
BUZZ  
&  
HUM**  
with

Use an EVER READY  
refill battery for your  
Electric Hand Lamp.

**EVER READY**  
TRADE MARK

**BRITAIN'S BEST BATTERIES**

The advertisement features a large, stylized circular graphic in the background. The top half of the circle is filled with a repeating pattern of the word "BUZZ" in a jagged, zig-zag font. The bottom half is a solid dark blue circle containing the text "Cut-out BUZZ & HUM with" in white. In the foreground, a box of Ever Ready batteries is shown at an angle. The box is blue and white with the brand name "EVER READY" prominently displayed. Text on the box includes "MADE IN ENGLAND", "12", "65 VOLTS", and "BEST BATTERIES". A thin wire is shown extending from the top of the battery box towards the center of the circular graphic. Below the battery box, the brand name "EVER READY" is written in a large, bold, outlined font, with "TRADE MARK" in smaller letters underneath. Below that, the slogan "BRITAIN'S BEST BATTERIES" is written in a similar bold font within a decorative frame.

*Mention of "The Wireless World," when writing to advertisers, will ensure prompt attention.*

*Tom Prendergast*

PROFESSIONAL "ENGINEER" IN THE SPECIALITY OF REPAIRING AND OBTAINING MAXIMUM EFFICIENCY IN ALL ELECTRIC APPLIANCES

24, UPPER BROOK ST.,  
MANCHESTER.

Dec. 11th, 1929.

The Sheffield Magnet Co.,  
116/126, Broad Lane,  
Sheffield.

Gents,

In answer to yours of the 9/12/29, I beg to state that you are at liberty to make any use of the P.C. posted to you on Saturday last. Since writing you this, I have carefully gone over the "Mullard Master Three" set, and the 120 Volt H. Tension "Exide" Batteries, and in conjunction with your "KUKOO" Unit, I now get results that are really surprising and pleasing. I do get Moving Coil results and far sweeter than most M. Coils on the market. There is absolutely no trouble in fixing your Unit to a 36" Baffle Board as I use. With a Vellum (pure) Cone-- surrounded with a Chamois leather edging (Cone made shallow) I get wonderful reception. I intend making 2" more Loud Speakers.

Yours etc.,

*Tom Prendergast*

**K  
U  
K  
O  
O**

**Actual Proof — that  
The SUPER SPEAKER UNIT**

DOES GIVE MOVING COIL RESULTS.—Entirely unsolicited Testimony from a user unknown to us personally.

Specially designed Kukoo Chassis and 10 1/2" Cone, 15/6 post free.



Post 9d.

Sole Patentees & Manufacturers —  
THE SHEFFIELD MAGNET CO.  
BROAD LANE, SHEFFIELD.

Phone — 20866.  
Grams — Magnet 20866 Sheffield.

42 Canterbury Avenue  
Fulwood  
Sheffield

30th December 1929.

Dear Sirs,

It may interest you to learn that nearly 12 months ago I purchased from my dealer a GARDNER PERMANENT MAGNET MOVING COIL LOUD SPEAKER which has daily been in service on a "Philips all main three".

Personally I have never heard a Speaker I like so well as both music and speech come through so perfectly and naturally, and all my friends who have heard it have a like opinion.

Through my recommendation my brother purchased one recently and is most satisfied with the results obtained. It was only through this transaction I found that the GARDNER SPEAKER was actually made in my own city hence this belated unsolicited testimony which you may use as you wish.

Yours faithfully,

*P. White*

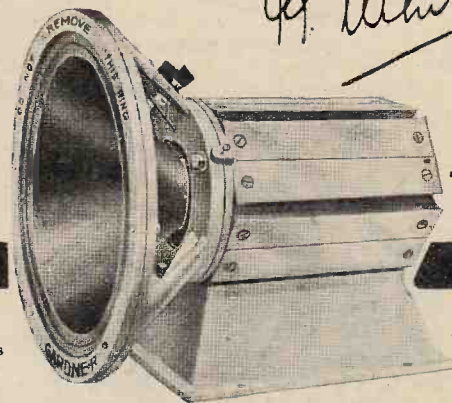

PRICE  
**£6**  
NET.

No Batteries Needed.

**THE GARDNER Permanent Magnet MOVING COIL SPEAKER.**  
Made by THE SHEFFIELD MAGNET Co.,  
BROAD LANE, SHEFFIELD.

# A Vote of Confidence in the T.C.C.



by the **B.B.C.**!

HERE is a testimony of the confidence placed by those who *know*, in T.C.C. The British Broadcasting Corporation specified T.C.C. Condensers for use in their high power Brookmans Park transmitter. For such a job, only condensers having an extremely high standard of efficiency, of accuracy, of dependability could be considered and T.C.C. condensers were installed. Whether it's a bank of condensers illustrated above or just a small 2 m.f. condenser for eliminator smoothing T.C.C. are to-day the recognised standard. Consider this when you need a condenser.

The illustration above shows the bank of smoothing condensers tested to 24,000 V.D.C., for working at 12,000 V.D.C., installed at Brookman's Park.

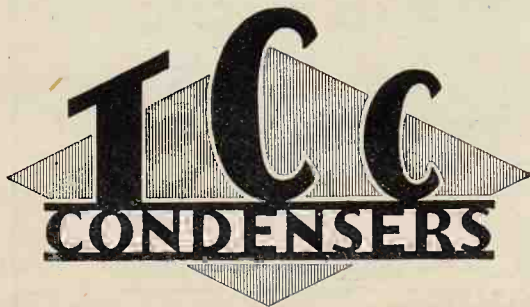

Adv. Telegraph Condenser Co. Ltd., Wales Farm Road, N. Acton, London, W.3.



3374

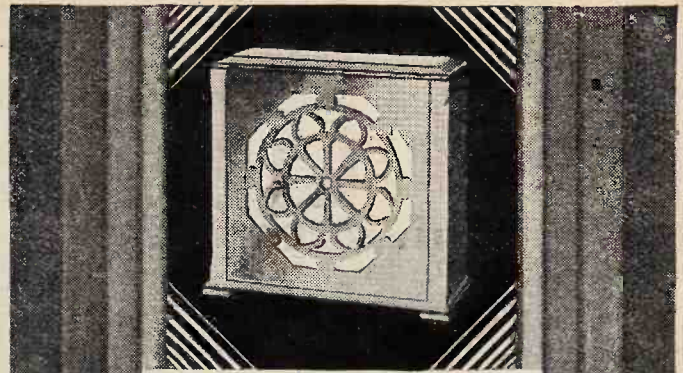

## THE NEW CELESTION LOUD SPEAKER MODEL Z.20

PERCY HARRIS, a foremost radio expert, writes in the "Wireless Constructor"—"Z20, renowned for brilliancy and quality . . . . speech and music particularly good . . . . a handsome instrument."

Gloriously realistic in tone . . . holding undisputed rank as the finest of all loud speakers

*Model Z.20 is designed specifically to give the finest possible results with any set from a Two-Valve to a Power Amplifier. Crowned with the Celestion hall-mark—a beautifully designed and hand-polished cabinet.*

In Oak . . . . . £7 . 15 . 0.  
Mahogany . . . . . £8 . 5 . 0.  
Walnut (to order) . . . £9 . 0 . 0.  
Other Celestion models from £3.15.0.

## CELESTION

The Very Soul of Music

WRITE FOR AN ABSORBING FREE BOOK ON "SOUND RE-CREATION"

London Showrooms:  
106, Victoria Street, S.W.1

Write to: Celestion Ltd.,  
Dept. C  
Kingston-on-Thames

202

Mention of "The Wireless World," when writing to advertisers, will ensure prompt attention.

A2

# DUBILIER

**CONDENSERS**  
ARE USED IN ALL THE MOST  
SELECTIVE SETS.

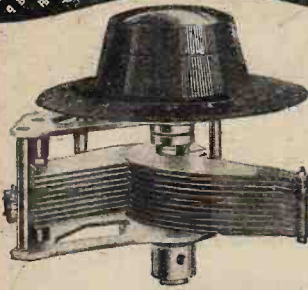

### K.C. CONDENSER

With knob, dial and slow-motion device, .0003 or .0005 **12/-**

Without knob, dial or slow-motion device, .0003 or .0005 **8/-**

### K.C. DRUM CONTROL CONDENSERS

With Drum Control and slow-motion device, .0003 or .0005 **15/6**

Triple K.C. each condenser, .0003 or .0005 **38/6**

Triple K.C. Combinations of .0003 and .0005 **40/-**

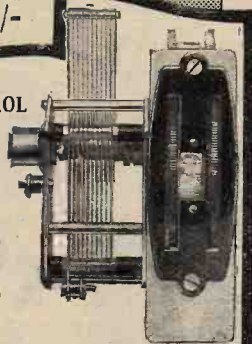

### MIDGET CONDENSER.

A small variable condenser for panel mounting, .0005, .0001 or .0002. Complete with knob **5/6**

Ask your dealer for the Dubilier Booklet—  
"A Bit about a Bit."  
—It's free.  
If you have any difficulty in obtaining Dubilier products write to us direct giving the name and address of your dealer.

# DUBILIER

CONDENSER CO. (1925) LTD.  
Ducon Works, Victoria Road,  
North Acton, London, W.3.

Cleaver

BC 275/v.

# FERRANTI RADIO

*The three essentials of radio reception—  
Purity of tone, Volume, and Selectivity  
—are well and truly balanced ★*

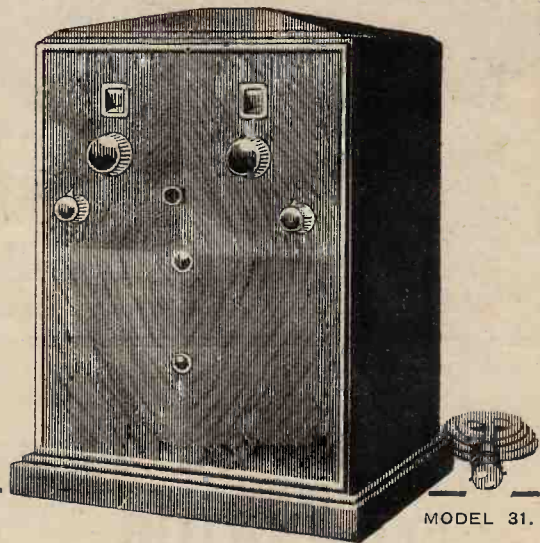

MODEL 31.

**T**HE FERRANTI "All Electric" Radio Receiver is designed by experts in the art, and built on sound engineering principles.

★ Whilst we make no extravagant claims we can definitely declare that our Set has been scientifically measured and compared with many others, and found equal to any and better than most in all the three essentials.

The price, including valves, is £25 in Oak Cabinet, and £26 in Walnut or Mahogany Cabinet. The Royalty is £1 extra. This set is available for **Alternating Current mains only**, voltages 200/250, 40 cycles or over.

*A special order from your dealer will ensure prompt delivery.*

Write for illustrated book, and, if you are interested, we will arrange for a demonstration in your home.

FERRANTI LTD. HOLLINWOOD LANCASHIRE



# GIVE YOUR SET NEW "PEP"

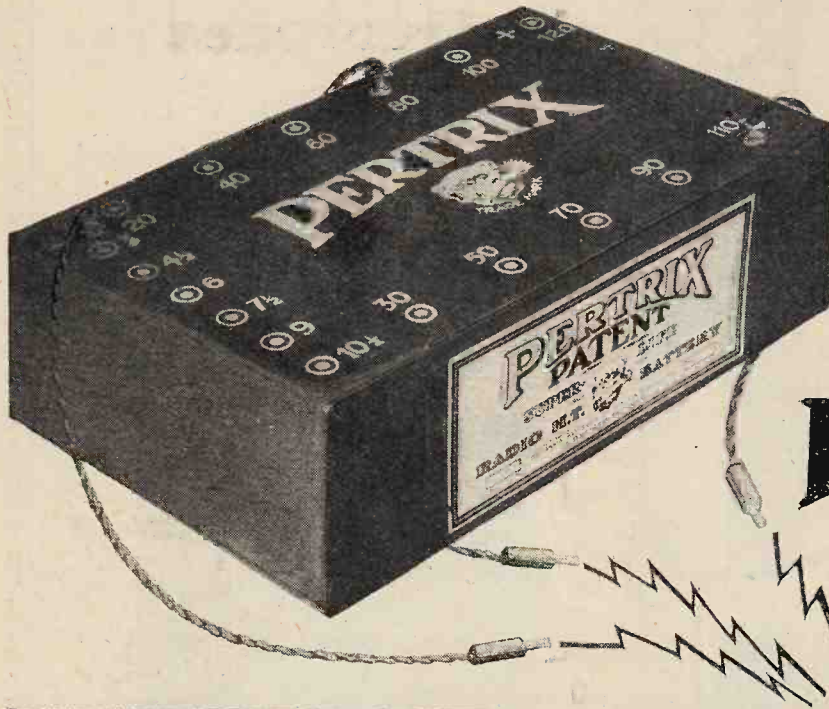

WITH "PERTRIX"

You can do it with "Pertrix" H.T. Batteries!

There is no sal-ammoniac in "Pertrix" to strangle and corrode . . . to shorten life and mar the enjoyment that comes from perfect radio.

Your H.T. Battery is the heart of your set. Give it a good heart . . . a heart full of life and power. Give it "Pertrix" — the H.T. Battery with a 60% longer life.

## PERTRIX

**SUPER LIFE  
RADIO DRY BATTERIES**

*The Battery of Batteries.*

Pertrix Ltd., 233, Shaftesbury Avenue, London, W.C.2.

Factory — Britannia Works, Redditch, Worcs.

The  
**FACTOR of SAFETY**  
in any  
**ELIMINATOR**

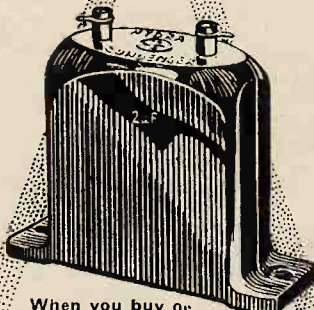

When you buy or build an eliminator, make sure of safety by insisting upon the "condenser that never breaks down" — because every Hydra Condenser is tested far above the rated working voltage and so you get at once a high margin of safety when you fit Hydra.

# HYDRA

LOUIS HOLZMAN, 37, Newman Street, London, W.1

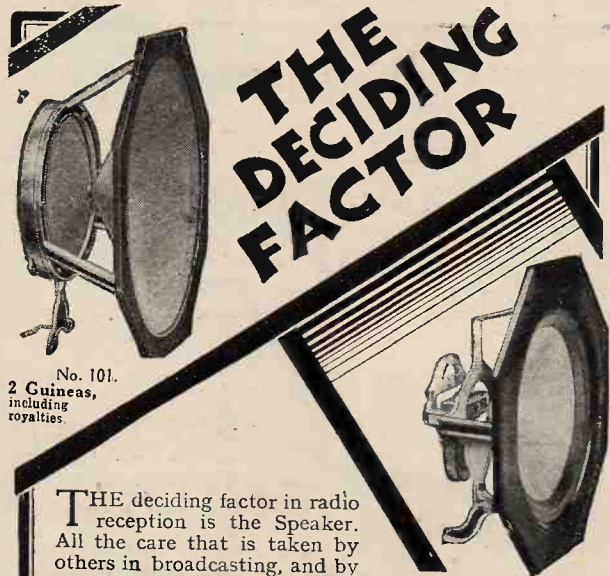

## THE DECIDING FACTOR

No. 101.  
2 Guineas, including royalties.

THE deciding factor in radio reception is the Speaker. All the care that is taken by others in broadcasting, and by yourself in using a good circuit, will be wasted if your Speaker is a poor one. Therefore we ask you to take the first opportunity of hearing a Squire or Speaker with a good Unit. We definitely claim that the quality of reproduction afforded is equal to, if not better than, that of the most expensive Speaker on the market.

No. 97b. 15/-

The No. 97b, also shown here, with a cone of the latest climate-proof vellum type and constructed of solid cast aluminium, absolutely preventing chatter, will take any Unit at present on the market.

Frederick Squire Ltd., 10, Leswin Place, Stoke Newington, N.16.

Mention of "The Wireless World," when writing to advertisers, will ensure prompt attention.

**All who prefer Quality  
in Cigarettes**



Say  
**Player's  
Please**

**5 for 3d. 10 for 6d.  
20 for 11½d.**



N.C.C. 722

**When buying**

**your A.C. Mains Receiver,  
battery eliminator, or  
battery charger**

**see that it incorporates**

**A**

**WESTINGHOUSE**

**METAL RECTIFIER**

which is one of the most important components in up-to-date radio equipment. There is nothing to wear out in this rectifier—no filaments, no chemicals nor moving parts. It is used in the majority of modern receivers and eliminators, designed and marketed by experts who are satisfied as to its reliability, and whose aim has been to provide TROUBLE-FREE RADIO EQUIPMENT.

For those who prefer to make up their own sets, our book "The All-Metal Way, 1930" will be invaluable. It contains 32 pages of circuits and instructions covering all types of A.C. Mains Units. Send a 2d. stamp with your name and address.

**The Westinghouse Brake & Saxby Signal Co. Ltd.,  
82, York Road, King's Cross, London, N.1.**

# ARE YOUR COMPONENTS UP-TO-DATE?



## BURTON DIFFERENTIAL CONDENSER.

A new addition to the famous range of BurTon Condensers. Scientifically designed, brass vanes, interleaved with Bakelite leaves, this condenser makes shorting an impossibility. It means easier tuning, better selectivity and better detection. The price is only 5/-

Look into your set! Are your components up-to-date? Are you getting maximum performance? Replace any defective part with a BurTon—the very last word in wireless components. Easy to assemble, smooth in action and absolutely reliable, BurTon components are the finest on the market.

Always replace with a BurTon!

**BurTon L.F. Transformer.**  
Highest efficiency, high grade finish. Price 10/6

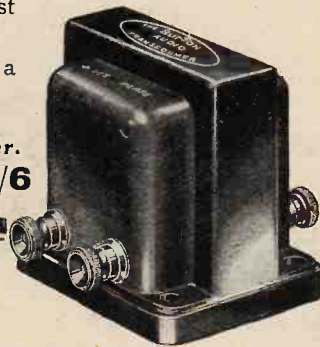

# BUY BURTON COMPONENTS

C. F. & H. BURTON, Progress Works, Walsall.

# NEW ELECTRAD SUPER-TONATROLS



These new Electrad variable non inductive high resistances will safely dissipate 5 watts at any position of the contact, with one-tenth or more of the resistance element in circuit. The all-metal construction with the graphite resistance element fused to an enamel base obviates the necessity of using either a low-current paper element or fine wire. The action is amazingly smooth, long lived and both mechanically and electrically perfect.

The Super-Tonatrol embodies new ideas of proved merit with generous factors of safety which more than fulfil all expectations. Super-Tonatrols are made in seven resistance ranges, taking care of all possible requirements.

No.	Resistance	Control Type	List Price each
No. 1 A.	25,000-ohm	potentiometer	12/6
" 2 A.	10,000-ohm	potentiometer	12/6
" 3 A.	50,000-ohm	rheostat	12/6
" 4 A.	10,000-ohm	rheostat	12/6
" 5 A.	100,000-ohm	potentiometer	12/6
" 6 A.	25,000-ohm	pick-up volume control	15/-
" 7 A.	50,000-ohm	fourth terminal pick-up fader volume control	15/-

Write for our 1930 catalogue and audio manual. It tells you all about Electrad resistances, volume controls, power amplifiers, etc. for electrical gramophones. Send 6d. in stamps for this 68-page booklet.

**ROTHERMEL CORPORATION Ltd.**  
24, MADDOX ST., LONDON, W.1.

'Phone : Mayfair 0578-9.

## BRING THAT STATION TO YOUR HOME

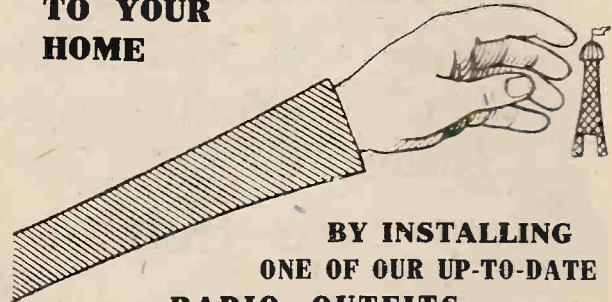

BY INSTALLING ONE OF OUR UP-TO-DATE RADIO OUTFITS  
**SIMPLICITY EFFICIENCY ECONOMICAL**

SEND YOUR MAINS SUPPLY VOLTAGE WITH YOUR ENQUIRY  
FULL ADVICE & DETAILS ON REQUEST

CATALOGUE FREE — BY POST 6d.

**WILL DAY LTD.**  
19, LISLE STREET,  
LEICESTER SQ., W.C.2.

'PHONE : REGENT 0921-22.

# MAZDA P.625 A

EFFICIENCY  
AND  
ECONOMY

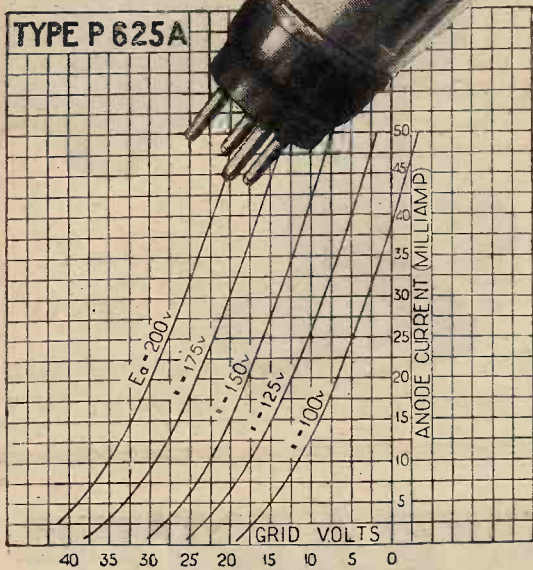
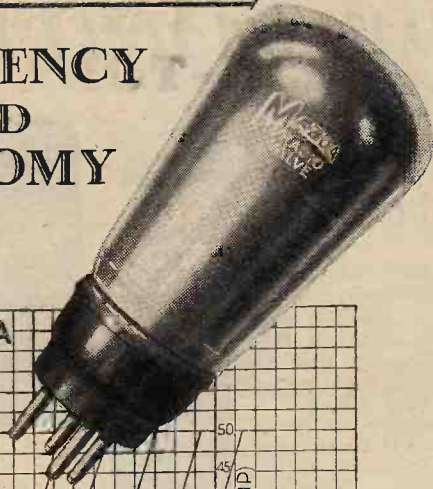

MAZDA P.625a

Type P625A is a super-power valve, and is capable of giving a high power output without distortion. It has been designed for operating cone and moving-coil type loud speakers. The volume obtained with this valve when used in the final L.F. stage is sufficient for most purposes, whilst the quality of reproduction over the whole of the musical range is bound to please all lovers of good music.

Those who desire a large volume of sound and better quality of reproduction should fit the valve in the final stage of their receivers.

These valves can be supplied matched for push-pull work.

PRICE 15/-  
The AMAZING

# MAZDA RADIO VALVES

THE EDISON SWAN ELECTRIC CO., LTD.  
Ediswan Radio Showrooms:  
1a, NEWMAN STREET, OXFORD STREET, W.1.  
(\*Phone: Museum 9801.)  
Showrooms in all the Principal Towns. V.20.

# Some amazing figures!

## Report of test by the FURZE HILL LABORATORIES

A thorough test was made of the Graham-Farish H.F. Choke by Mr. Resner of the Furze Hill Laboratories. The following figures are extracted from his report—

Wave length.	Impedance.
200 metres.	43,500 ohms.
245 ..	50,000 ..
380 ..	80,000 ..
480 ..	147,000 ..
500 ..	150,000 ..
880 ..	255,000 ..
1,460 ..	385,000 ..
2,400 ..	126,000 ..

The Graham-Farish H.F. Choke was designed to obtain high impedance with low D.C. resistance, and these figures will show the success that has been achieved by careful research and scientific design.

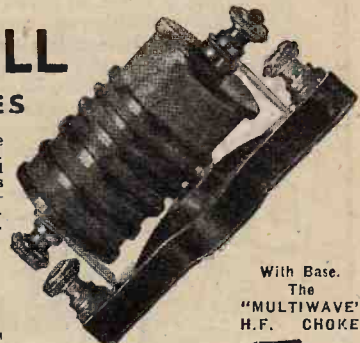

With Base.  
The  
"MULTIWAVE"  
H.F. CHOKES.

5/-



2/3  
each

The famous "ORMITE"—a moulded Anode Resistance with a value that remains constant. Infinitely better than wire-wound. Hermetically sealed in Bakelite. Noiseless and efficient. Negligible self capacity, so that the high notes are retained. Also fitted with terminal ends. All values, 1,000 to 500,000 Ohms. Holders, Horizontal or Vertical. 6d. each



4/6  
each

The New "MICRO-FICIENT" Condenser, a brass-vaned log-mid-line variable condenser using Bakelite as a dielectric. Robust in construction, and ideal for portable sets. Can be mounted for either drum or ordinary dial control.

.0005 mfd.	4/6
.0003 ..	4/3
.00015 ..	4/3

# GRAHAM FARISH

BROMLEY



KENT

146/7

# A wonderful combination!

The Lewcos High Frequency Choke and recently developed L.F. Transformer combine to give perfect radio reception.

## LEWCOS L.F. TRANSFORMER.

Treble notes respond admirably, whilst the bass notes are reproduced with an effect more nearly approaching the true musical tones than is possible with the majority of makes. A feature of the L.F. Transformer is the provision of a Centre-Tapping on the secondary winding which renders it adaptable for push-pull amplification.



Scientific research, finest materials and sound workmanship make the L.F. Transformer a worthy addition to the Lewcos range

## LEWCOS H.F. CHOKE.

Tested values of the Lewcos H.F. Choke:

Self-capacity—1.62 micro-micro-farads (N.P.L. test).

Natural Wave-length — 5,200 metres (tested with Moullin voltmeter).

These figures give assurance that there will be a minimum amount of H.F. leakage through self-capacity, while the position of the terminals, one at the top of the coil and the other at the base, is arranged so as to eliminate the risk of additional self-capacity in the wiring of a receiver.

Size: 2 1/4" x 2 3/8" x 3 1/2"

Price 30/-



# LEWCOS

REGD.  
THE LONDON ELECTRIC WIRE COMPANY AND SMITHS LTD.,  
CHURCH ROAD, LEYTON, LONDON, E.10.  
Trade Counter: Playhouse Yard, Golden Lane E.C.1.



20-2000 metres.  
Price 7/9

Get improved reception with this long-life BATTERY

66 Volts 7/9

SUPERIOR (Single Capacity)	
9 volts ..	1/6
99 volts ..	11/9
63 " ..	7/6
108 " ..	12/9
66 " (with G.B. Tappings) ..	7/11
SUPREME (Treble Capacity)	
60 volts ..	13/6
63 " ..	14/3
100 " ..	22/-

Get Dubilier's Booklet—"A Bit about a Battery"—from your Radio dealer



BRITISH MADE

# DUBILIER H.T. BATTERIES

DUBILIER CONDENSER CO. (1925) LTD., Ducon Works, Victoria Rd., North Acton, London, W.3. B13

# WEARITE COMPONENTS

## 1930 EVERYMAN FOUR.

Coils per set £2-7-6

## NEW KILOMAG FOUR.

Coils per set £2-5-0

## WIRELESS WORLD KIT SET.

Coils per set £2-5-6

## DECOUPLING RESISTANCES.

500 or 600 ohms .. 1s. 6d.  
Fixed resistances wire wound  
1,000-5,000 10,000 15,000 20,000 25,000 ohms  
2/- 2/6 3/- 3/6 4/- each

## FOREIGN LISTENERS FOUR.

B.B.C. Coils, per set of 3 £1-2-6  
5XX Coils, per set of 3 £1-17-6  
Coil Bases, per set of 3 £0-7-6

Write for illustrated lists:

WRIGHT & WEAIRE, LTD.  
740, HIGH ROAD, TOTTENHAM, N.17.  
Telephone: Tottenham 8847/8. 144

Mention of "The Wireless World," when writing to advertisers, will ensure prompt attention.

# Don't spoil the fun...

Whether the dance music is coming over the radio or from the radiogramophone—let them have it good and strong! Don't spoil the fun by using an H.T. battery that cannot give your valves all the current they demand. The C.A.V. rechargeable H.T. Accumulator gives purest reception, because the voltage remains as steady as a rock and there is no limit to the current flow.

It will reveal to you a hidden power, a quality of reception previously unknown, for your valves will, for the first time, be working at 100 per cent. efficiency.

A C.A.V. Accumulator will reduce your expenses too; it is rechargeable like your low tension accumulator, and will not require replacement for years.

Write to Dept T.3 for latest Radio Accumulator Catalogue.

**CAVandervell & Co. Ltd.**  
ACTON, LONDON, W.3

Specify the C.A.V. Jelly Acid Battery—The Perfect L.T. for all Portables.



buy



*High Tension  
Accumulators*

Built  
like  
Car  
Batteries.

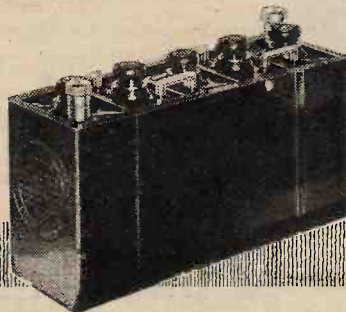

10 VOLT UNITS  
2,500  
Milliamps 5/-  
5,000  
Milliamps 6/3  
10,000  
Milliamps 12/-

## IF YOUR SUPPLY MAINS ARE D.C.

You can use an A.C. All Electric Receiver  
By Employing The M.L.—D.C. to A.C.

### ROTARY TRANSFORMER

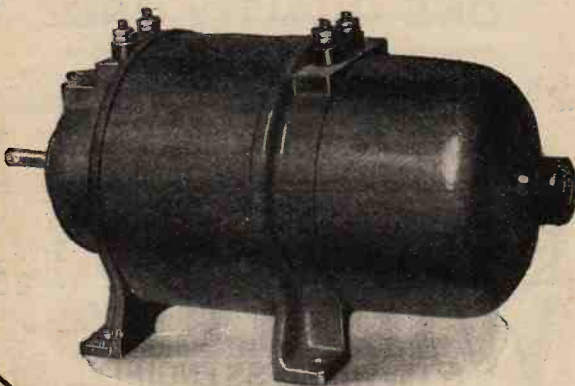

Can be supplied  
to run from  
any Voltage  
12-250 V.D.C.

Recommended and  
used by

Philips Radio,  
Marconiphone,  
Burndept,  
Kolster-Brandes,  
M.P.A., Etc., Etc.

40 WATT Model  
£13-0-0

85 WATT Model  
£19-0-0

**M-L MAGNETO SYND. Ltd., Radio Dept., COVENTRY.**

Telephone: 5001.

## Get the Experts to Advise You:— The R.G.D. Radiogramophone



For the highest possible quality and tone for both radio and record, with ample volume, incorporating the latest developments in moving coil speaker; operates entirely from electric mains, A.C. any voltage, or D.C. 200 volts or over.

Mahogany **£80**      Oak **£75**

*Place your order now to ensure delivery and we shall be pleased to supply literature on application.*

**The Radiogramophone Development Co.,**  
St. Peter's Place, Broad Street, Birmingham.

## Superior A.C. POWER TRANSFORMERS and CHOKES for the MAINS

from **35/-**  
for all  
Inputs  
and  
Outputs



*Special Audio - Frequency Chokes and Transformers, and Smoothing Chokes for all purposes.*

**WILLIAM BAYLISS LTD.,** Sheepcote Street,  
Telephone: Mid. 1409.      Telegrams: "Drawbench, B'ham." **BIRMINGHAM.**



## WIRELESS from the Mains SWITCH ON FOR £2-7-6



L.T. from £2 : 12 : 6



H.T. from £2 : 17 : 6

Hear deep bass notes and all the orchestra constantly.  
Don't hear your radio perfectly only while the batteries are 'right up' but get full H.T. and L.T. supply always.

Connect to your set (a matter of a few moments) and plug into the electric light, no danger, no trouble . . . just switch on.

**"TANNOY" UNITS ARE CHEAPER.**

H.T. complete from . . . £2-17-6  
L.T. " " " £2-7-6

**TULSEMERE MANFG. CO.,**  
1-7, Dalton St., West Norwood, S.E.27  
Tel: Streatham 6731.

## Mains Units

# PARFAIT

THE PERFECT  
EBONITE PANEL  
ONE QUALITY ONLY  
— THE BEST —

SUPPLIED IN SIX FINISHES: Matt, Semi-Polished Mahogany, Highly Polished Black, Cube Surface, Highly Polished Mahogany, Semi-Polished Black.  
Stocked by most Wireless dealers. If any difficulty in obtaining locally, write for name of nearest stockist to:  
**H. B. POTTER & Co., Ltd.,** Station Buildings, ROCHDALE.

# EXPERIMENTAL WIRELESS

& The WIRELESS ENGINEER

The Journal for Professional Engineers and Advanced Wireless Experimenters

Monthly 2/6 net.

Annual Subscription 32/- post free.

ILIFFE & SONS LTD., Dorset House, Tudor Street, London, E.C.4.

*Mention of "The Wireless World," when writing to advertisers, will ensure prompt attention.*



## FOR ELIMINATOR CIRCUITS

You cannot afford to use any but the best Condenser in an eliminator circuit.

### HELSEBY CONDENSERS

are made and guaranteed by a firm with 30 years' experience in condenser making, from small telephone and radio condensers to Power Condensers weighing upwards of 2 tons.

Guaranteed working voltages :-

Type M	-	-	150 volts D.C.
Type 2A	-	-	350 volts D.C.
Type 3A	-	-	450 volts D.C.
Type 4A	-	-	600 volts D.C.

All Helsby Condensers are vacuum dried and impregnated with a special non-hygroscopic material which renders them moisture proof.

If unobtainable from your dealer, write to us giving his name and address.



## BRITISH INSULATED CABLES LTD

PRESCOT - LANC'S.

Makers of PRESCOT and HELSEBY cables

# The BETTER SERVICE BATTERIES

They're BRITISH



Super Quality Only

- W.L. 204P. 66v. 9/6.
- W.L. 205P. 66v. 17/6.
- W.L. 208P. 103v. 15/6.

Get an Ediswan H.T. battery and note the silent background—the perfect reception. It will give you good service, too — your Ediswan battery — and it will still be going strong long after another battery would have been relegated to the dust bin.

IF IT'S

# EDISWAN

IT'S BETTER

THE EDISON SWAN ELECTRIC CO., LTD.,  
123/5, Queen Victoria Street, London, E.C.4.  
Showrooms in all the Principal Towns. B.54.





**RIGID!**

**SECURE! LOCKED!**

**THE ONLY  
SCREENED  
GRID VALVE  
WITH  
INTERLOCKED  
CONSTRUCTION**

Because of the exceptional strength and rigidity of its elements due to its Interlocked Construction the *NEW* Cossor Screened Grid Valve has definitely established itself as the most robust and the most dependable Screened Valve made in Great Britain. Over and over again in actual service it has proved itself shock-proof, noise-proof and break-proof. In your Receiver use the New Cossor Screened Grid Valve. Every Dealer sells it.

**2-volt type  
now available.**

The *NEW* Cossor 220 S.G. (2 volts 2 amp.) Anode volts 120-150, Impedance 200,000 Amplification Factor **22/6** 200. Price - - -

Cossor 4 and 6 volt Screened Grid Valves are also available with similar characteristics at the same price.

The **NEW**  
**COSSOR**  
Screened Grid  
Valve

A. C. Cossor Ltd., Highbury Grove, London, N.5

 3346

Mention of "The Wireless World," when writing to advertisers, will ensure prompt attention.

# The Wireless World

AND  
RADIO REVIEW  
(17<sup>th</sup> Year of Publication)

No. 544.

WEDNESDAY, JANUARY 29TH, 1930.

VOL. XXVI. No. 5.

Editor: HUGH S. POCKOCK.  
Assistant Editor: F. H. HAYNES.

Editorial Offices: 116-117, FLEET STREET, LONDON, E.C.4  
Editorial Telephone: City 9472 (5 lines).

Advertising and Publishing Offices:  
DORSET HOUSE, TUDOR STREET, LONDON, E.C.4.  
Telephone: City 2847 (13 lines). Telegrams: "Ethaworld, Fleet, London."

COVENTRY: Hertford Street.  
Telegrams: "Cyclist, Coventry." Telephone: 5210 Coventry.

BIRMINGHAM: Guildhall Buildings, Navigation Street.  
Telegrams: "Autopress, Birmingham." Telephone: 2970 and 2971 Midland.

MANCHESTER: 260, Deansgate.  
Telegrams: "Hiffe, Manchester." Telephone: 8970 City (4 lines).

GLASGOW: 101, St. Vincent Street, C2.  
Telegrams: "Hiffe, Glasgow." Telephone: Central 4357.

PUBLISHED WEEKLY.  
Subscription Rates: Home, £1 1s. 8d.; Canada, £1 1s. 8d.;  
other countries abroad, £1 3s. 10d. per annum.  
Entered as Second Class Matter at New York, N.Y.  
As many of the circuits and apparatus described in these pages are covered by  
patents, readers are advised, before making use of them, to satisfy themselves  
that they would not be infringing patents.

---

CONTENTS OF THIS ISSUE.

	PAGE
EDITORIAL VIEWS	107
SIZE VERSUS EFFICIENCY OF SMALL COILS. BY A. L. M. SOWERBY	108
ACCURATE WAVEMETER DESIGN. BY W. H. F. GRIFFITHS	113
CURRENT TOPICS	115
MULTI-RANGE METER CONVERSIONS. BY W. A. BARCLAY	117
WEIRD WIRELESS. BY D'ORSAY BELL	120
WIRELESS THEORY SIMPLIFIED, PART XVIII. BY S. O. PEARSON	122
NEW APPARATUS REVIEWED	124
BROADCAST BREVITIES	126
CORRESPONDENCE	127
READERS' PROBLEMS	129

## THE POST OFFICE AGAIN.

WE are glad to be able to publish in the Correspondence columns in this issue a letter from the Post Office which reassures us on the question of wireless licences in flats, to which we drew attention editorially in our issue of January 15th, under the title of "A Wireless Licence Scandal."

The Post Office reply is quite explicit and exonerates Post Office officials from all responsibility. The wireless correspondent of an important daily paper, whose published statement was so misleading, would not find it easy to excuse himself, for his statement read:—

"The Post Office contended at the outset that one licence would not be sufficient for a big set like this at Baker Street, but they were convinced in the end that only one ten-shilling licence need be taken out, because there is only one set and one building."

We have no further comment to make on this question now that it has been satisfactorily cleared up, but another matter has arisen where the Post Office is concerned, to which we feel that attention should be drawn. Recently a very splendid piece of work was done by

Mr. Cyril E. Baron, who during the recent gales picked up SOS calls from a ship in distress in the Channel, and, finding that the calls were not being answered, communicated the information by telephone to the North Foreland Radio Station, and by this action was the means of saving the ship and the lives of those on board. Following this action, Mr. Baron received a letter of thanks from the Post Office.

We consider that Mr. Baron's action was one deserving of high appreciation, and we are very glad to see that the Postmaster-General took what we consider to be the very proper step of making acknowledgment of the assistance which he rendered. This incident, however, provides the opportunity for drawing attention once more to the broadcast licence regulations printed on the back of the licence form which we have previously criticised in *The Wireless World*. Following upon the decisions of the Washington International Wireless Conference, certain changes were made in the conditions under which broadcast licences are issued, and the wording on the back of the form now states that the licensee may only use his receiver for the reception of

"broadcast programmes and messages sent for general reception and messages sent from an experimental station in connection with experiments carried out by the licensee,"

and, further, that

"The licensee shall not use or allow the station to be used for the receipt of messages other than messages intended for receipt thereby or sent for general reception."

A perusal of the wording of this regulation makes it quite clear that, in his action with regard to Mr. Baron, the Postmaster-General has publicly approved of a breach of the Post Office regulations. Mr. Baron would have been unable to act as he did unless he had been listening to transmissions other than those permitted.

The Mullard Wireless Service Company was, we believe, the first to communicate the story of Mr. Baron's experience to the Press, and a statement in their report is, we think, significant of the general attitude towards what we regard as the unreasonable regulations of the Post Office. The paragraph to which we refer reads:—

"In addition to the material broadcast officially from the studios, there is a wealth of unofficial messages continually 'on the air.' Many listeners have derived considerable pleasure in picking up messages sent out from Croydon Airport to air planes making the passage between England and the Continent. Moreover, those who are expert at reading the Morse code occasionally amuse themselves by listening to ships at sea."

The Post Office cannot hope to prevent or control what listeners overhear on wireless receivers, however desirable it may be that secrecy should be observed, so that it seems to us only foolish to make regulations which cannot be enforced.

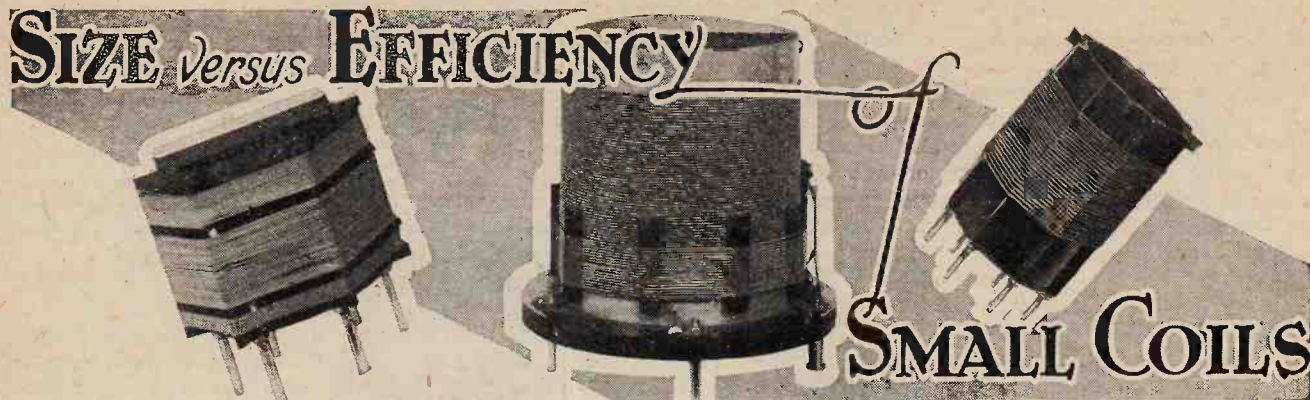

## The Advantages of Low Stage Gain and Small Coils for Multi-stage Receivers.

By A. L. M. SOWERBY, M.Sc.

THE continuous evolution of the valve, and especially of the valves used for high-frequency amplification, is likely to open up divergent lines of receiver design. On the one hand, these new valves offer the possibility of attaining a tremendous amplification in a single stage, and will therefore tempt many designers to replace two moderately efficient stages by a single "hotted up" stage giving superlatively high magnification. Besides the obvious advantage of the elimination of one valve, there must also be taken into consideration the fact that by adopting a design of this type, of which the "Record III" is an example, it becomes possible to use a band-pass filter while still not employing more than three tuned circuits. Further developments in this direction are not impossible, but it would appear probable that receivers of this general type will be limited to amateur construction, for which they are particularly suited.

The second possible line of development is similar in its aims, but different in its means of attaining them. Instead of pushing up the amplification until one stage, using a modern valve, will do the work that two valves did before, we may lower the efficiency of the tuned circuits to keep amplification still at or near its old level, taking our profits in the form of less "peaky" tuning and greater ease of ganging the tuned circuits if this should be thought desirable. The "Foreign Listener's Four" is an example of a receiver designed on these lines. Judging by the present trend of commercial set design, it is in this direction that the manufacturer is most likely to progress.

It will be realised, of course, that from the commercial standpoint a set of this kind is the more practical proposition, in that careful elimination of losses always adds very considerably to the cost of manufacture, and increases the likelihood of the finished receiver requiring a final adjustment by highly skilled experts before it can be passed as perfect. Moreover,

a commercial receiver has to work with almost any valves that may happen to find their way into it, and so must not be dependent for its good behaviour on an expert's final touches.

For all these reasons, then, a multi-stage receiver of low stage gain suits the manufacturer. From an amateur's point of view, too, it has its points. Although it is an extremely difficult task to set up and operate two ultra-high-gain stages, it is comparatively easy to extract the same overall amplification from three low-gain stages. To attain a total magnification of 25,000 times in two stages, each stage must amplify about 160 times. It is not difficult to stabilise one such stage, but two in cascade offer very considerable difficulties even to the expert. But if three stages can be used, the 25,000 times can be made up at the much more modest rate of 29 times per stage. This implies coils of quite high resistance, or transformers of high step-up ratio, so that a little stray reaction will not set up oscillation quite so infallibly as with the high-gain stages; in addition, there should be no great difficulty in ganging the tuned circuits without incurring any loss of amplification.

It will therefore be seen that a receiver deliberately made inefficient by choosing tuned circuits of higher losses than the amateur set builder usually permits has something to offer in exchange for its higher cost of construction and greater demands on the batteries. Those who do not mind providing an extra valve and an extra tuning coil and condenser, together with an extra screening box and decoupling components, will find that the multi-stage receiver of low gain is pleasant to use and offers good selectivity for a reasonably small loss of side-bands.

With receivers of this type (though not necessarily of three stages) in mind, a series of small, compact and inexpensive coils have been designed. Some discussion arose as to the best inductance to choose for these coils,

*TO what extent will the performance of a receiver be impaired by using compact tuning coils of the order of 2 in. diameter? Based on laboratory measurements, this article clearly shows that while the use of such coils may reduce the amplification per stage, this can be outweighed by permitting easy ganging and producing stability.*

**Size versus Efficiency of Small Coils.—**

and it was finally decided that 200 microhenrys should be fixed upon, partly because this inductance value goes well with a 0.0005 mfd. tuning condenser, which is the most generally used size, and partly because it ensures that even if, by compact construction and close shielding, the stray capacities in the finished receiver are brought up to high values, the wavelength range that they cover will still extend as far as is likely to be required in a downward direction. It should, however, be noted that where 0.00035 mfd. tuning condensers are available, and stray capacities can be kept reasonably small, 250 microhenrys is to be preferred. With the higher inductance the amplification does not fall off quite so much at the upper end of the waveband, and at the same time the higher ratio of in-

gauge. In doing this, the decrease of dynamic resistance shown by all tuned circuits at the upper end of their tuning range was borne in mind, and as a small contribution towards lessening this effect the gauge of wire was chosen to suit 600 metres instead of a wavelength more nearly at the middle of the range.

The specifications arrived at by calculation are as follows:—

COMPACT COILS ; 200 MICROHENRYS.

No.	Diameter.	Wire Gauge.	Wire Covering.	Turns.
1 .....	2 3/4 in.	22	Double Silk	57
2 .....	2 1/4 in.	22	Double Silk	64
3 .....	2 1/4 in.	24	Double Cotton	71
4 .....	2 in.	26	Double Cotton	80
5 .....	1 3/4 in.	28	Double Silk	73
6 .....	1 1/2 in.	28	Double Silk	90

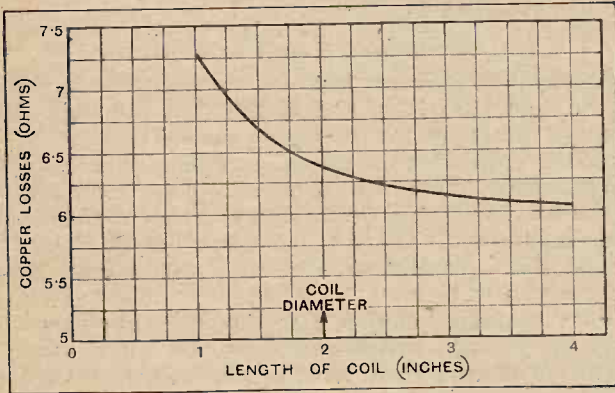

Fig. 1.—Relation between copper losses and length of coil. The inductance is 250 microhenrys and the diameter 2in.

ductance to capacity helps to flatten out the tuning curves and tends to check undue loss of side-bands.

In designing the coils, the method adopted was to take the diameter as a basis. Butterworth's formulæ show that, for a fixed diameter, the lowest coil resistance is attained by making the coil very long. By calculating the copper losses for a number of coils of the same diameter, but of different lengths, it was found that the resistance at first decreased fairly rapidly as the length was increased, but that after increasing the length to equal the diameter, any further improvement that could be attained was not worth the extra space that the coil would occupy. The relation between copper losses and coil length, for the particular case of a 250 microhenry coil of 2in. diameter, is shown in Fig. 1.

**The Correct Gauge of Wire.**

It should be noted that this result is not in contradiction with the well-established fact that the best coil shape is that which makes the diameter about double the winding length. This rule applies to a series of coils in which the overall surface is kept constant, both diameter and length changing when passing from one shape to another. If with a fixed diameter the length of the coil is increased, the departure from the best shape is more than counterbalanced by the increase in overall surface area.

Having settled the shape of the coil, it only remained to apply Butterworth's formulæ to find the best wire

All coils are intended to be wound with consecutive turns of wire touching; it is with the idea of providing automatically correct spacing that various coverings are specified.

It was considered advisable, for the interest of those who may wish to employ coils of this type in a receiver, to make actual measurements of the high-frequency resistance of some at least of these coils, since dielectric losses in the tuned circuit are usually of such a magnitude that the copper losses alone cannot be taken as a guide in receiver design. Coils Nos. 2, 4, 5 and 6 were therefore wound, the former being paxolin tube bearing the trade-mark "MIC." First, the inductance of the various coils was measured, and was found in no case to be exactly 200 microhenrys. This turned out to be

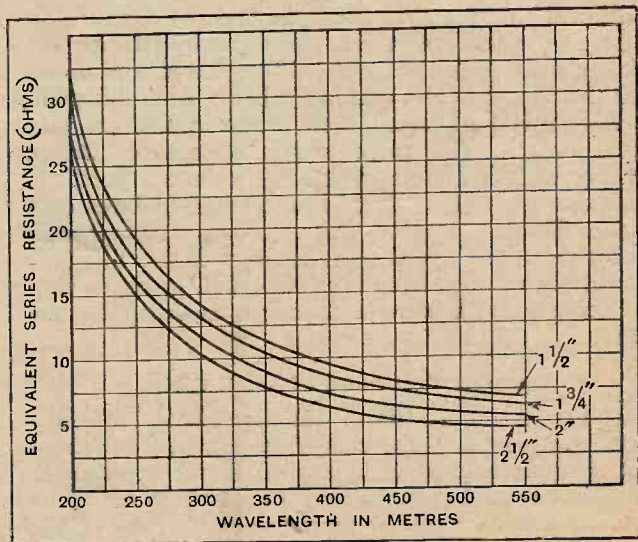

Fig. 2.—Equivalent series resistance of complete tuned circuit embodying 200-microhenry coils.

due to the fact that the particular wire employed did not conform exactly to the overall diameter (including insulation) attributed to it in the wire tables used. The specifications, however, have not been amended on that score, as it is probable that the diameters given in the

Handwritten notes and calculations at the bottom of the page, including numbers like 29, 26, 58, 41, 84, 7569, 1082, and 24389.

**Size versus Efficiency of Small Coils.—**

tables represent average diameters reasonably closely, while any corrections introduced would only be applicable to the particular sample of wire that happened to be used for the individual coils measured.

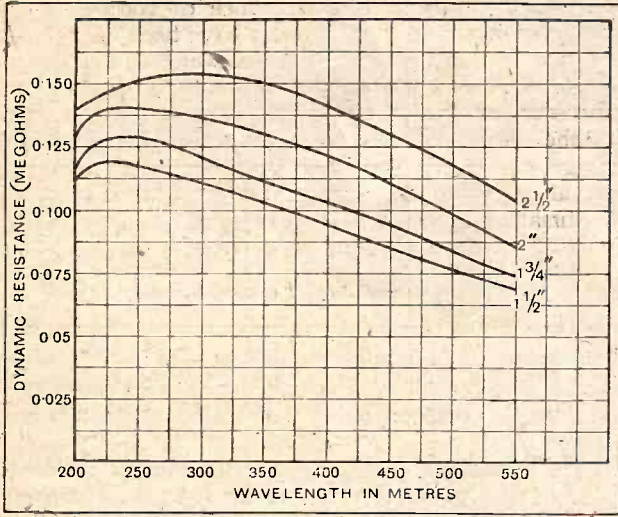

Fig. 3.—Dynamic resistance of typical tuned circuit incorporating 200-microhenry coils.

The equivalent series resistance of a complete tuned circuit, using each of the four coils in turn, was next measured. Besides the coil itself the tuned circuit contained a variable condenser in which the fixed plates were supported on ebonite. In order to reproduce the conditions existing in a practical receiver, a valve and valve-holder, together with a 3-megohm grid-leak, were connected in parallel with the tuned circuit. A "Burton" valve-holder was chosen as introducing unusually small dielectric losses; although it is not implied that there is no holder that is not better from this point of view, it is quite certain there are many that are very much worse. The valve was a Marconi or Osram HL610, while for the grid-leak was chosen a porcelain holder, owing to the fact that porcelain introduces only minute dielectric losses. This selection of components makes the tuned circuit representative of one in which the dielectric losses have been kept well in hand without going to such extreme measures as decapping the valve.

**Dynamic Resistance of Small Coils.**

In Fig. 2 the results of these resistance measurements are plotted. The curves do not, as a matter of fact, reproduce exactly the figures found experimentally, but have been to some extent adjusted to the values that the writer regards as representative of an average case. It was found necessary to "cook" the results in this way because the largest coil, which should naturally have had the lowest resistance, turned out to have a higher resistance, over part of the waveband, than any of the others. Analysis of the figures showed this to be due to an unusually large share of dielectric losses—presumably in the paxolin former, since every other factor was unchanged from coil to coil. It is

thought, however, that the curves give, as they stand, a fair estimate of the resistance that may be expected in other coils made up to the same specification on good quality formers, and connected in a tuned circuit containing the same components.

In addition, the resistances found were all adjusted on the basis of constant magnification ( $m = \frac{2\pi f L}{r}$ ) to

the values they would have had if the inductances of all four coils had been exactly 200 microhenrys.

For receiver design, the series resistance of tuned circuits is of less interest than the dynamic resistance, since knowledge of the latter is required for the calculation of stage-gain, and in the choice of amplifying valves to precede the coils. The dynamic resistances of the same four tuned circuits at different wavelengths is therefore given in Fig. 3.

**The Auto-coupled Tuned Grid Circuit.**

As might be expected from the compact construction of the coils, their dynamic resistance is not high—it averages only some 100,000 ohms or so. The very considerable drop towards the upper end of the tuning range is partly due to the comparatively low inductance of the coils, and partly to the fact that they are wound with solid wire. The dynamic resistance of a Litz-wound coil is usually more nearly constant from low wavelengths to high.

For maximum amplification in a high-frequency stage employing a screen-grid valve, the tuned anode circuit, or its equivalent, must be used with these coils.

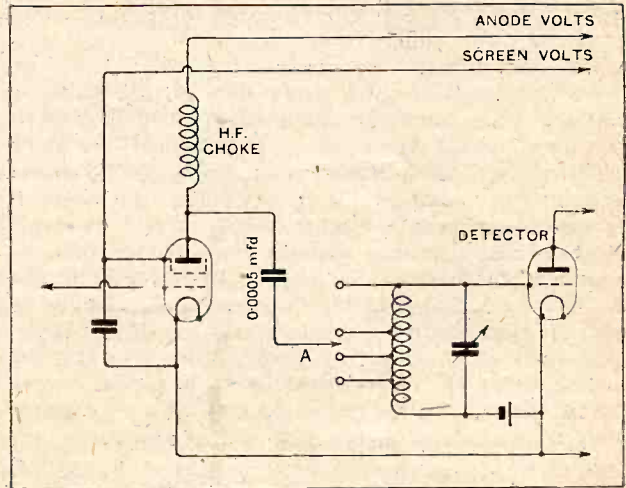

Fig. 4.—Tuned grid H.F. coupling, using tapped coil. By connecting the lead A to different tapings, selectivity, amplification and stability can be varied until the best compromise is found.

If higher selectivity is required, a step-up transformer of ratio about 2 to 1 will be found very suitable, and will help towards providing stability in a multi-stage amplifier. This extra stability may be indispensable if screen-grid valves having a high residual grid-plate capacity are employed.

A remarkably convenient method of intervalve coupling is suggested in Fig. 4, which shows a "tuned grid" circuit employing a choke and coupling con-

**Size versus Efficiency of Small Coils.—**

denser for parallel feed. No separate primary winding is required for this arrangement, a tapping on the coil serving to convert it very simply into an auto-transformer. Where there are doubts as to the selectivity

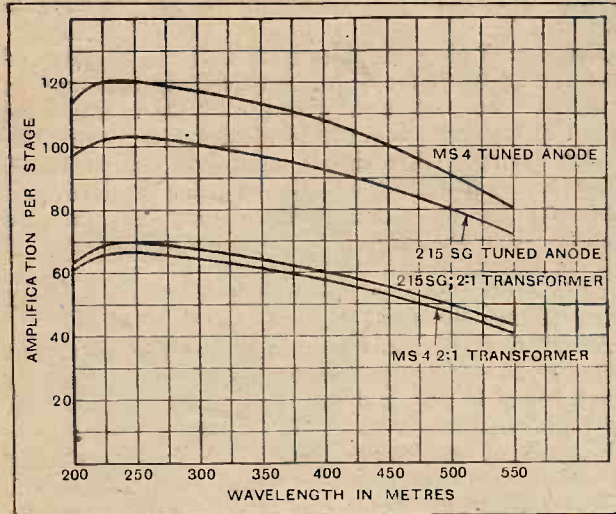

Fig. 5.—Amplification per stage with 2in. coil, as tuned anode coil and as secondary of 2:1 step-up transformer.

or stability of the amplifier, several different tapings may be provided, so that when the amplifier is being tested the most satisfactory compromise between selectivity, stability and amplification may readily be found by trying different tapping points.

The amplification per stage given by the 2in. coil, with the Mazda 215SG battery-heated valve and the Marconi MS4 mains valve, has been calculated, and is given in Fig. 5. The upper pair of curves refer to the use of the coil in the tuned-anode circuit or its equivalent (in the circuit of Fig. 4, with the lead from the coupling condenser connected directly to the upper end of the tuned circuit), while the lower pair give the amplification that may be expected if the coil is used as the secondary of a 2-to-1 step-up transformer (in Fig. 4, with the tapping at the mid-point of the coil).

**Inductance Affected by Close Screening.**

The high stage-gain that the best modern valves can provide, even with such modest coils as these, enables a receiver of high overall magnification to be built in a comparatively small space.

With coils of the type described here, which are of small dimensions and are comparatively long for their diameter, the extra resistance introduced by putting the coils inside screening boxes will be found quite small. Even with much larger coils of quite low resistance and more extended field it is possible to allow the screens to approach surprisingly close to the coils before any serious increase in resistance occurs. It must not be forgotten, however, that the close proximity of metal will lower considerably the inductance of a coil, and if too closely screened there may be a failure to tune over the wave-range expected.

If a series of these coils is to be used in cascade in a multi-stage amplifier it becomes desirable to have some idea of the overall resonance curve to be expected. On the assumption that the damping due to the anode impedance of the valve will be equivalent to shunting each tuned circuit with a resistance of 200,000 ohms the curves shown in Figs. 6 and 7 have been calculated. The two-way logarithmic scale on which these curves are plotted does not give, at first glance, a very correct impression of the shape of the resonance curve, but has the very considerable advantage that relative voltages can be read with the same percentage accuracy over all parts of the scale. This is of especial value in estimating selectivity, for which the height of the "skirt" of the curve has to be read.

**Resonance Curves.**

In examining the curves there are two points that claim special attention. For the proper reproduction of the high harmonics and overtones that serve to render one musical instrument distinguishable from another playing the same fundamental note it is necessary that the tuned circuits should pass frequencies up to some 5 kilocycles away from the fundamental at reasonable strength. The height at which the various response-curves cut the line marked "5 kc." thus enables the high-note loss involved by the various numbers of these coils at wavelengths towards the two ends of their tuning range to be estimated very readily. As a guide

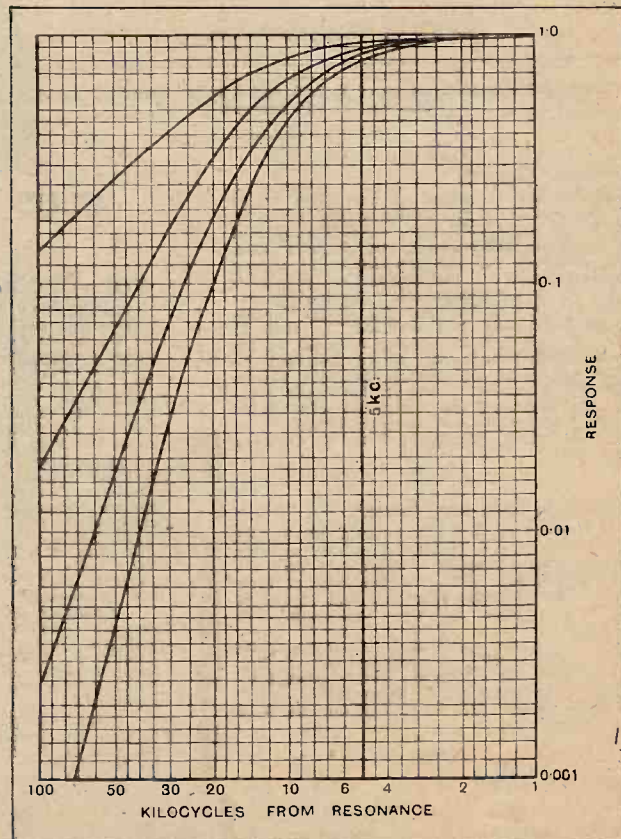

Fig. 6.—Resonance curves of 1, 2, 3 and 4 tuned circuits, using 2in. coil at 225 metres.

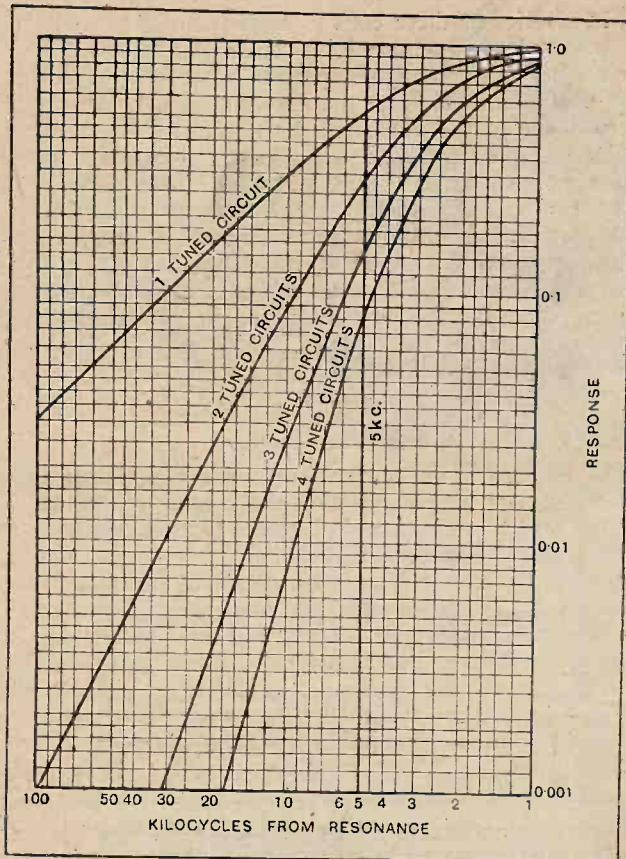

Fig. 7.—Resonance curve of 1, 2, 3 and 4 tuned circuits, using 2in. coil at 550 metres.

one might suggest that 10 per cent. at 5 kc. means acceptable quality, 25 per cent. means good quality, while 65 per cent. or over implies reproduction up to the best "local station" standard. But since different people have different opinions as to what constitutes "good quality" these figures need not be taken too rigidly, although they should assist in providing a clue.

The second piece of information that can be gathered from the curves is the degree of selectivity that may be expected. For determining this we must examine the height of the curve at a greater distance from the peak. If, for example, there is an interfering station B, 36 kilocycles away from the station A being received, and the curve for the tuned circuits in use cuts the line marked "36 kc." at 0.008, we know at once that B will be heard, as an interference to B's programme, at an intensity of 0.008 times that at which it is received when deliberately tuned in.

Attention is particularly drawn to the enormous difference in selectivity between the two figures, one of which refers to 225 and the other to 550 metres. At the latter wavelength selectivity is very high, and the side-bands of received telephony are very drastically cut down where three or four tuned circuits are used. At 225 metres even five or six tuned circuits would be perfectly harmless from this point of view, but selectivity is, of course, poor. For all-round reception, where any station that comes in well can be detuned a little, a three-circuit receiver would be found quite satisfactory even when high quality is required, for when the circuits are not accurately tuned to the station being received the resonance curve is broadened very considerably.

#### Short-wave Reception.

Loud-speaker reception on the short waves was the feature of the demonstration given by Mr. K. Alford, G2DX, before the Muswell Hill and District Radio Society on January 15th, when members had the opportunity of testing for themselves the distance-getting properties of the Igranac "Neutrosnic" 5-valve receiver which Mr. Alford had brought along. Transatlantic telephony was received, as well as hosts of short-wave telegraphy stations. In his accompanying lecture, Mr. Alford described the good work done by British amateur experimenters in the development of short-wave working, and described the difficulties experienced on the new 5-metre and 10-metre bands.

Hon. Secretary, Mr. C. J. Witt, 39, Coniston Road, N.10.

○○○○

#### "A.C. Mains Units and Circuits."

The Smethwick Wireless Society, at Empire House, High Street, Smethwick, whose call-sign is G2GX, recently made arrangements with the Marconiphone Co., Ltd., for the loan of their three lantern lectures, the first and second of which have been delivered to appreciative audiences.

The last lecture, entitled "A.C. Mains Units and Circuits," will be delivered on Friday, February 7th, at 8.30 p.m., and a cordial invitation is extended to all interested.

Hon. Secretary, Mr. S. S. Chatwin, 50, Pool Road, Smethwick.

○○○○

#### Rectification Filmed.

Mr. S. A. Stevens, B.Sc.(Eng.), A.C.G.I., D.I.C., of the Westinghouse Brake and Saxby Signal Co., Ltd., dealt with metal rectifiers in a recent lecture before Slade Radio (Birmingham). The difference between D.C. con-

## CLUB NEWS.

### FORTHCOMING EVENTS.

#### WEDNESDAY, JANUARY 29th.

Muswell Hill and District Radio Society. At 8 p.m. At Tollington School, Tetherdown, N.10. Lecture and demonstration: "The Testing of the Modern Gramophone Pick-up," by Mr. F. N. G. Levers.  
Edinburgh and District Radio Society.—At 8 p.m. At 16, Royal Terrace. Lecture: "Frame Aerial Reception," by Mr. H. F. Ferguson, M.B., Ch.B.

#### THURSDAY, JANUARY 30th.

Ilford and District Radio Society. At the Wesleyan Institute, High Road. Loud speaker demonstration.  
Golders Green and Hendon Radio Society. At 8.15 p.m. At the Club House, Willifield Way, N.W.11. The Fourth Dance, Slade Radio (Birmingham). At the Parochial Hall, Broomfield Road, Erdington. Junk Sale.

#### MONDAY, FEBRUARY 3rd.

Newcastle-upon-Tyne Radio Society. At 7.30 p.m. In the English Lecture Room, Armstrong College. Lecture: "The Anode Feed System," by Mr. W. W. Pope, followed by a demonstration of electrical reproduction.

#### TUESDAY, FEBRUARY 4th.

Thornton Heath Radio Society. At 8.15 p.m. At St. Paul's Hall. Demonstration by Mr. R. M. H. Lucy, of Messrs. S. G. Brown, Ltd.

#### WEDNESDAY, FEBRUARY 5th.

Institution of Electrical Engineers (Wireless Section). Visit to the Laboratory of the City and Guilds Engineering College, South Kensington, S.W.

verters and A.C. rectifiers was fully explained, and the lecturer gave an interesting record of the progress made in rectification problems. The lecture was followed by a display of the company's film, which provided living diagrams illustrating the performance of alternating and direct current. The Society, membership of which is open to anyone interested in wireless, holds its meetings every Thursday at 8 o'clock. Details may be obtained from the Hon. Secretary, 110, Hillaries Road, Gravelly Hill, Birmingham.

○○○○

#### A New Club.

A meeting to discuss the formation of a Radio Society in Market Harborough was held in the Old Grammar School on Thursday, January 16th, and nearly forty local enthusiasts enrolled as members. Dr. Crisp was elected president and Mr. F. Sketchley chairman. All interested are requested to get in touch with the Hon. Secretary, Mr. A. H. Richardson, "Fernleigh," Wartnaby Street, Market Harborough.

○○○○

#### A Successful Year.

At the Hackney Radio and Physical Society's eighth annual meeting held recently, the secretary's report showed that the past year has been a very successful one for the society.

The following officers were elected for 1930:—  
Chairman: Mr. E. Cunningham.  
Vice-chairman: Mr. W. J. Samson.  
Hon. Secretary: Mr. G. E. Sandy.  
Publicity Secretary: Mr. G. W. Heath.

An interesting programme has been arranged for the coming year, and the Society will be pleased to welcome new members. Anyone interested should apply for particulars to the Hon. Secretary, Mr. G. E. Sandy, 4, Meadway, Raynes Park, S.W.20.

# HEAR MUSIC

... as it  
*really is!*

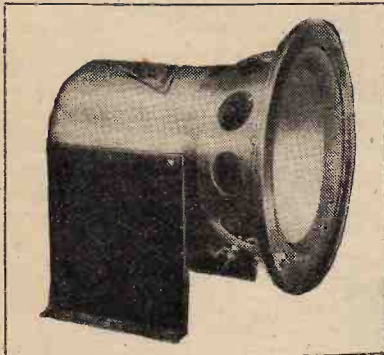
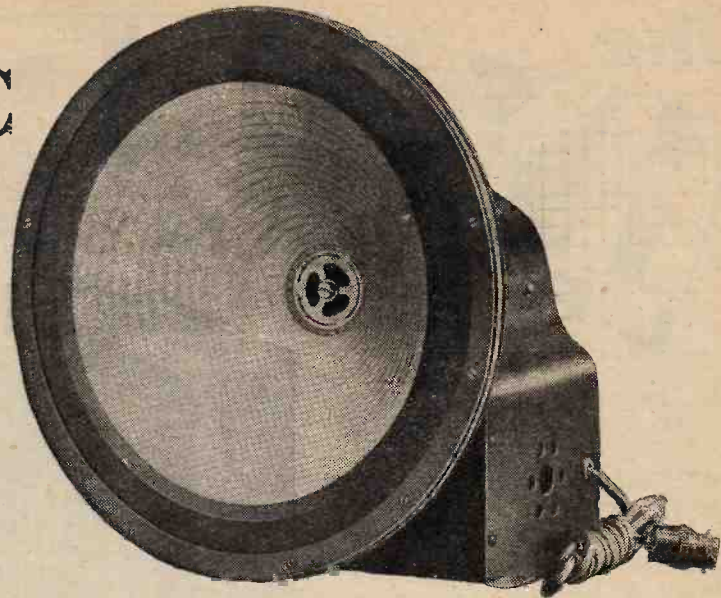

The Junior "R.K." Unit has a 6 in. straight-sided cone with moving coil having an impedance of 10-15 ohms at 50/4,000 cycles. Copper damping rings are fitted to reduce the impedance at the higher frequencies. Price £6 6 0

The Senior "R.K." Unit incorporates a 10 in. corrugated cone with moving coil having an impedance of 10/15 ohms at 50/4,000 cycles. Copper damping rings are fitted to reduce the impedance at higher frequencies. Price £7 7 0

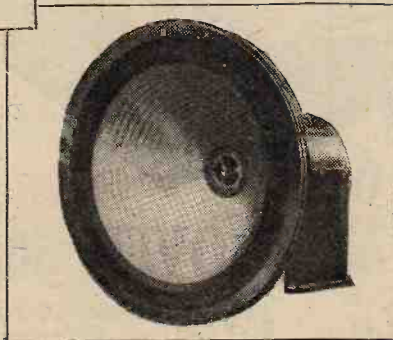

Senior "R.K." Unit with A.C. Field Excitation.

This "R.K." Unit has a 10 in. corrugated cone with moving coil having an impedance of 10-15 ohms at 50/4,000 cycles. The pot magnet is mounted in a pressed metal base which also contains a mains transformer, Mazda U.U. 60/250 rectifier valve, and smoothing condenser for the supply of field current. Price £11 10 0

When the "R.K." first appeared on the market it was hailed as the perfect reproducer and achieved instant leadership.

That leadership—so readily attained four years ago—is maintained to-day and wherever fine reproduction is desired the "R.K." is the speaker to use.



# REPRODUCERS



THE EDISON SWAN ELECTRIC CO., LTD.,  
Radio Division,  
1, Newman Street, Oxford Street, W.1.  
Branches in all Principal Towns.

## EDISWAN

W. 35.



# The HYPERMITE L.F. TRANSFORMER



Little Bigger  
than a match  
box & weighs  
only 7 ounces

12'6

## PRIMARY INDUCTANCE OVER 50 HENRIES

Here at last is a transformer built with a CORE OF A NEW NICKEL ALLOY of enormous permeability, yet sold at a price which places it within the reach of the average home constructor.

The "Hypermu" at 21/- is, of course, the best transformer it is possible to buy, but the "Hypermite" gives an opportunity of acquiring at the popular price of 12/6 a modern transformer with a high inductance which guarantees the retention of the low frequencies without sacrificing the high.

A "Hypermite" leaflet with full diagrams will tell you all about it. Ask your dealer for a free copy, or send direct to the manufacturers.

**RI** in connection with radio products is a guarantee of excellence throughout the world, and a comparison of this transformer with any of the bulky, expensive transformers will definitely establish its value.

A NEW NICKEL ALLOY CORE is now recognised as an essential feature of modern intervalve transformer design. The "Hypermite" is an absolute boon to SET MAKERS, who are most enthusiastic with its performance. They have already placed contracts for it for their 1930 Season for PORTABLE SETS.

The "Hypermite" will be one of the outstanding features of progress in Radio during the 1930 Season. Try it in your set. It justifies our claims.



12, HYDE STREET,

LONDON, W.C.1.

Mention of "The Wireless World," when writing to advertisers, will ensure prompt attention.

# Accurate Wavemeter Design

Points in the Construction of Precision Instruments.

By W. H. F. GRIFFITHS, F.Inst.P., A.M.I.E.E.

AT a meeting of the Institution of Electrical Engineers last year Capt. P. P. Eckersley, then Chief Engineer of the British Broadcasting Corporation, during his contribution to the discussion on wavelength standards, said: "Some years ago (wavelength) accuracies of 1 or 2 per cent. were sufficient for ordinary stations. To-day, particularly in the field of broadcasting, 1 part in 10,000 is desirable if mutual interference is to be avoided." Capt. Eckersley then explained the methods which are employed by M. Divoire (of the University of Brussels) to check the wavelength of all broadcasting stations of Europe from one central broadcasting control laboratory in Brussels. The wavelengths of ordinary 1 kW. broadcasting stations 1,000 miles distant from Brussels are measured to within 200 cycles in a million, an accuracy of 0.02 per cent.

It is natural, of course, that with the crowding of the available ætherial waveband the necessity for accurate determinations and standardisation of wavelength should be every-increasingly felt.

In the early days of "wireless" there was very little difference in accuracy between the carefully constructed standard wavemeter and one of an ordinary commercial type, whereas now we have wavemeters differing in accuracy by over a thousand to one. This must necessarily be the case when the measurement of any physical quantity becomes more precise, since the quality of workmanship then plays a far larger part in the overall accuracy of the instruments for its determination. Thus the accuracy of wavemeters (of any given type) to-day depends almost entirely upon the quality of their component inductances and condensers—particularly the latter.<sup>1</sup> It is obviously ridiculous to impart a highly accurate calibration to a wavemeter whose variable condenser is, through

mechanical imperfection, neither constant enough to "hold" this calibration nor sufficiently uniform in capacity variation to permit interpolation (between adjacent calibrated points) of the same high order of accuracy.

### The Relative Accuracy of the Various Types of Wavemeter.

The better the quality of variable condenser employed in any particular type of wavemeter and the smaller the wavelength range covered by a single sweep of its condenser, the more accurate will be its calibration.

The extent to which the accuracy of a wavemeter is determined by the quality and range of its variable air condenser varies with different types. In the case of the simple buzzer wavemeter, for instance, flatness of tuning will sometimes limit accuracy of reading and so render condenser quality of less importance. And in a wavemeter of the heterodyne type the quality and range of the variable condenser will only be the governing factor of accuracy if the initial calibration conditions of valve emission, etc., are exactly reproduced on all subsequent occasions.

The sub-standard wavemeter of the simple resonant circuit type is, on the other hand, almost entirely governed, as regards accuracy, by the quality and range of its variable air condenser, although the constancy of the inductance associated with the latter is also of importance.

The relative inaccuracy of the various generalised types of wavemeters is depicted diagrammatically in Fig. 1 by the relative areas of circles—the variation of accuracy being far too great for representation on a linear basis. To those inexperienced in the field of standardisation and

measurement, the outstanding feature of this diagram is, perhaps, the relatively high inaccuracy of a good portable commercial heterodyne wavemeter. One must remember, however, that this inaccuracy, even if one ignores all other contributing factors, may be introduced by an uncertainty of capacity of 1 or 2 microfarads, and that such a variation of capacity may be due to a great variety of causes in a portable instru-

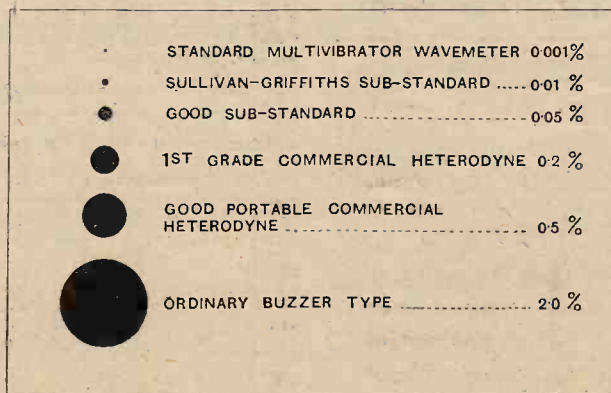

Fig. 1.—The relative inaccuracies of various types of wavemeter are shown proportional to the areas of the circles.

<sup>1</sup> W. H. F. Griffiths, "Notes on the Accuracy of Variable Air Condensers for Wavemeters."—*Experimental Wireless*, vol. IV., No. 51, December, 1927.

Also W. H. F. Griffiths, "The Accuracy and Calibration Permanence of Variable Air Condensers for Precision Wavemeters."—*Experimental Wireless*, vol. V., Nos. 52 and 53, January and February, 1928.

**Accurate Wavemeter Design.**

ment such as non-permanence of wiring, change of self-capacity of range coil, and the earth capacity introduced by the proximity of the hand during operation, as well as to the chief cause—that of post-calibration capacity change in the variable condenser itself.

**The Design of the Resonant Circuit of a Wavemeter for Accuracy.**

It is of primary importance, therefore, that the minimum value of capacity of the variable air condenser of a heterodyne wavemeter shall be augmented by a fixed condenser to such an extent that these unavoidable capacity uncertainties are rendered less important by

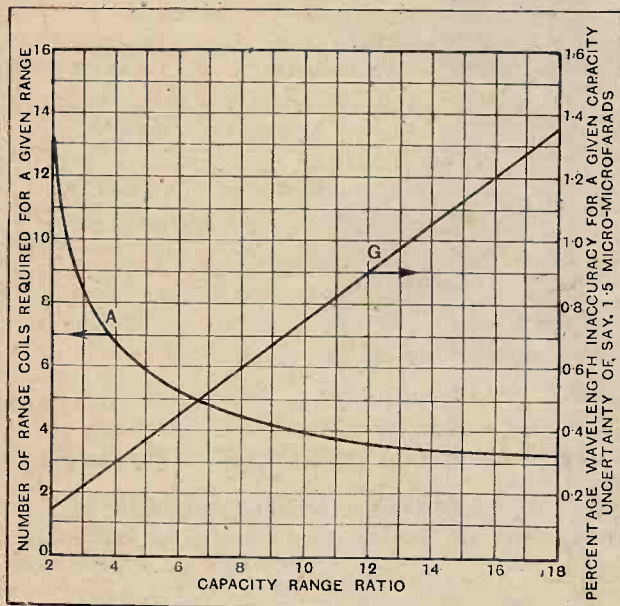

Fig. 2.—Curves showing the number of range coils and capacity ratio of condenser of a wavemeter.

being made a smaller percentage of the total circuit capacity. The range of wavelength covered by a single sweep of the condenser will, of course, be very considerably reduced even by a small increase of minimum capacity, and this will, in turn, increase the number of "range coils" required to cover a given total wavelength range, thus adding appreciably to the cost of the instrument and making it less convenient to use. For a wavemeter either of the heterodyne or sub-standard (absorption) type the number of range coils required to cover a certain band of wavelength can be found from a curve such as (A) of Fig. 2, which is plotted for a wavelength range ratio of 100 to 1 (irrespective of the actual wavelength values), corresponding with any desired capacity range ratio of variable condenser.

In order to use this curve, however, one must first determine the capacity range ratio of the variable condenser to be employed. Since this depends upon the accuracy required of the wavemeter it is possible to plot another curve, Fig. 2 (G), connecting these two quantities. The right-hand scale in this case represents the

inaccuracy to be expected due to capacity uncertainty in an ordinary commercial heterodyne wavemeter. Lower inaccuracy values would, naturally, be associated with laboratory sub-standard wavemeters.

Commencing therefore with only the total wavelength range and percentage inaccuracy permissible as data, the resonant circuit is designed by finding from curve G the capacity range ratio corresponding with the inaccuracy permissible and then from curve A finding the number of range coils corresponding with this capacity ratio. The ratio of the inductances of successive range coils will, of course, be the same as that of the condenser and their values are thus easily calculated.

For a variable condenser and wavemeter of any given quality the inaccuracy due to a small uncertainty of capacity will depend upon the total value of circuit capacity and any curve of inaccuracy such as G must be associated with one definite value of maximum capacity—in this case 1,000 micro-microfarads.

**Tuning Range and Percentage Inaccuracy.**

In Fig. 3 curves similar to those of Fig. 2 are given for the outline design of wavemeter circuits having various values of inaccuracy, for any value of total wavelength range, and for any value of maximum capacity. The curves A, B, C and D are plotted for wavelength ratios of 100 to 1, 40 to 1, 20 to 1 and 10 to 1 respectively. For other wavelength ratios interpolation between the curves may be applied and the next higher whole number of range coils employed. The straight line curves E, F, G, H and J give inaccuracy—capacity ratio relationship for circuits having maximum capacities of 500, 750, 1,000, 1,500 and 2,000 micro-microfarads respectively.

The curves have been made more complete by the addition of an alternative scale of percentage inaccuracy

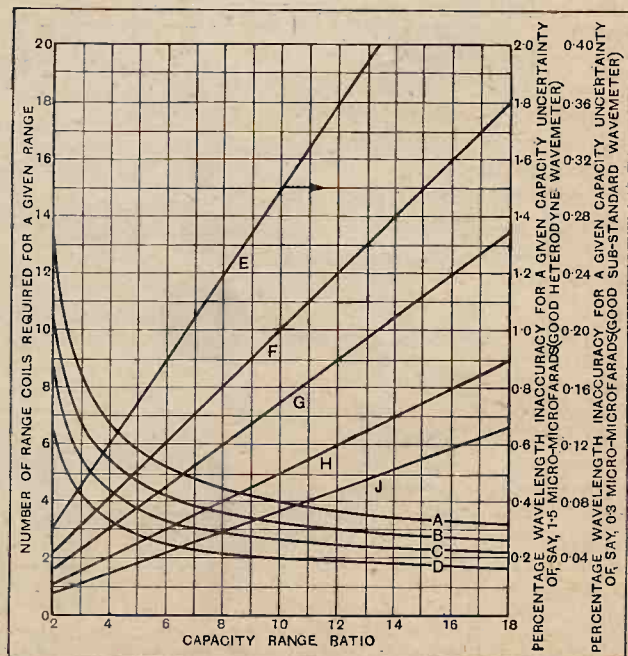

Fig. 3.—Showing the number of range coils and capacity ratio of condenser of wavemeters of various accuracies.

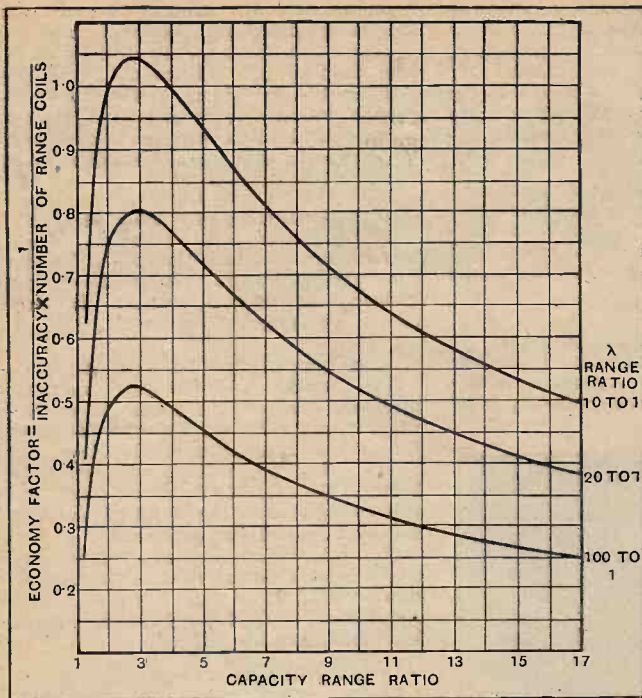

Fig. 4.—The optimum economic capacity range for wavemeters having regard to accuracy, cost and convenience.

to be used when the wavemeter under consideration is of the better-class substandard absorption type employing a precision variable condenser and well-designed range coils.

It will, of course, be understood that in the use of these curves only that component of inaccuracy which is due to capacity uncertainty is accounted for, and although this should always form the basis of design the possibility of other sources of inaccuracy should not be overlooked.

**Optimum Capacity Range.**

As will be seen from Fig. 3, the number of range coils rendered necessary becomes prohibitive if the capacity range ratio is reduced too much and, moreover, the attendant reduction of capacity uncertainty is not sufficiently great to justify this above a certain point. The value at which a still further reduction of capacity range ratio does not justify the added cost and inconvenience of extra range coils is found by plotting curves (as in Fig. 4) of economy factor against capacity range ratio. The economy factor is assumed to be the ratio of accuracy to number of range coils, the accuracy, of course, being taken as the reciprocal of inaccuracy. The curves of Fig. 4, which are plotted for wavelength ratios 10 to 1, 20 to 1 and 100 to 1, indicate an optimum economy value of capacity ratio of about 2.7, which is, incidentally, that employed in the best wavemeters.

(To be concluded.)

Events of the Week

**FRANCE'S DX PRESIDENT.**

President Doumergue is reported to be a wireless "fan" of the DX type, leaving his bed in the early hours to listen to America.

o o o o

**RADIO WEEK FOR IRELAND?**

The organisation of Irish Radio Week is being considered by the Irish Radio Traders' Association.

It seems to us that before the Free State can stage an effective Radio Week it will be necessary to provide a broadcasting service covering a bigger area of the country.

o o o o

**WIRELESS IN PUBLIC LIBRARIES.**

The Sheffield libraries are setting an example to the country by allowing the public free facilities for listening to the B.B.C. language talks. Sets are in regular operation at the Walkley and Hillsborough branches, and visitors are invited to join the discussion groups which have been formed in connection with the B.B.C.'s Adult Education campaign.

o o o o

**AS OTHERS HEAR US.**

Brookmans Park is receiving "a good press" in France, according to our Paris correspondent. Several journals draw the attention of the public to the excellent transmission from the new station, while "Petit Radio" praises the station for the prudent care taken to "minimise in-

**CURRENT TOPICS**

In Brief Review

convenience as a result of the application of new conditions of reception." This cryptic remark probably indicates satisfaction at the constancy of the Brookmans Park wavelengths.

o o o o

**MARITIME TRIBUTE TO WIRELESS.**

A long-standing association between seafarers and the wireless service has been acknowledged by the Worshipful Company of Shipwrights by the admission of Mr. F. S. Hayburn, deputy managing director of the Marconi International Marine Communication Co., Ltd., as a Freeman and Liveryman.

o o o o

**PROPOSED NEW RADIO COLLEGE.**

A new form of wireless college, specially intended for youths who wish to enter the wireless trade, has been proposed by the Association of British Radio Societies, whose headquarters are in Manchester. It is believed that a need exists for a training centre in which the student would have an opportunity of handling modern commercial apparatus, such as moving-coil loud speakers, etc., of a kind

which is usually absent in the ordinary technical colleges. While the theoretical side would not be neglected, the aim of the course would be to give the learner an acquaintance with the practical problems associated with the trade.

It is stated that the scheme has met with the approval of several important wireless firms.

o o o o

**TONIC TOUCHES IN AUSTRALIA.**

In Australia the month of January is witnessing the acquisition of more stations by the Australian Broadcasting Company, the latest to come under its control being Adelaide, 5CL, and Brisbane, 4QG. The recent broadcast legislation makes the "A.B.C." responsible for the direction of seven stations, two in Sydney, two in Melbourne, and one each in Brisbane, Adelaide, and Perth.

The company announces its intention of putting fresh life into the programmes.

o o o o

**GREECE TO "COME ON THE AIR."**

The "Isles of Greece" will shortly resound to the strains of national broadcasting as a result of the decision of the Hellenic Government to invite offers from organisations who would be prepared to operate a State-subsidised broadcasting service, the income to be derived from listeners' licence fees. At present there are no applicants for the monopoly, but the Ministry of Posts and Telegraphs is

determined to waste no time on the question and has already ordered a certain amount of transmitting equipment from the Marconi Company and the French Compagnie Radio Electrique. The sites chosen for the studios are at Zanli, Vari, and Sitta (Crete), with high-power transmitters at Athens, Chios, and Heraclion (Crete).

○○○○

#### EVERLASTING GRAMOPHONE RECORDS?

Startling claims are made in a Washington message regarding the properties of a new type of gramophone record composed of a substance called Durium. The inventor is Dr. Hal T. Beans, professor of chemistry at Columbia University. The records consist of thin sheets of cardboard on which a coating of

call from the Turin station is produced by a real bird. Considering that so many birds, including canaries, nightingales, and cuckoos, are specially trained for broadcasting work, we feel sure that the station authorities would not deceive listeners with a gramophone record.

○○○○

#### LEAMINGTON'S LOUD SPEAKERS.

The Leamington Town Council has submitted a draft bylaw to the Home Secretary for the suppression of noisy loud speakers and gramophones in public places.

○○○○

#### A BORROWED WAVELENGTH.

Congestion on the long-wave broadcasting band has led to an interesting situation in regard to the wavelength of

and the line will handle not only the increasing telephone business between Toronto and the northern Ontario mining districts, but will be a link in the Atlantic-Pacific system. On the completion of this transcontinental project persons in Halifax will be able to talk to Vancouver over an all-Canadian route with perfect audibility.

○○○○

#### MORE "SUPERHETS" FOR FRANCE.

The Etablissements Radio-L.L., which manufacture and sell "superhets" under the patents of M. Lucien Lévy, has trebled its capital, which is now 35 million francs.

○○○○

#### OPPORTUNITIES IN THE R.A.F.

The trade of wireless operator-mechanic is among those open to successful applicants for six hundred vacancies for aircraft apprentices in the Royal Air Force. The apprentices, who must be between the ages of fifteen and seventeen, will be enlisted as the result of an Open and of a limited Competition.

Full information regarding conditions and prospects can be obtained on application to the Royal Air Force (Aircraft Apprentices' Dept.), Gwydyr House, Whitehall, London, S.W.1.

○○○○

#### GRAMOPHONE NEEDLE WEAR.

We regret that, owing to a printer's error, three illustrations were misplaced in the article appearing under the above title in our last issue. The photographs represented as Figs. 2, 4 and 6 should have appeared as Figs. 4, 6 and 2 respectively. The descriptive captions appeared in their correct places.



**PREMIER'S SHORT-WAVE TALK.** On Wednesday last the Prime Minister broadcast a special address to American and Dominion listeners on the subject of the Disarmament Conference. Mr. Ramsay MacDonald is here seen before the microphone in the Cabinet Room at Downing Street. The address was transmitted only from 5SW, the Empire broadcasting station, and listeners in this country were unable to hear it.

Durium is laid by a dipping process. On these the impressions can be stamped at the rate of 200 records per minute. The inventor affirms that the records are practically everlasting.

○○○○

#### PUBLIC LISTENING HALLS.

"I have often wondered why somebody has not opened a public Radio Hall for listening to wireless programmes," says a writer in *The Manchester Guardian* Commercial Edition. "Home audiences must of necessity be scanty from 11 a.m. to 6 p.m., and there are lots of people whose opportunities for evening listening are very limited who would appreciate daytime facilities in an airy hall with comfortable seats and rubber flooring. Wireless manufacturers might help to finance such a scheme in return for exhibiting their sets and gadgets."

○○○○

#### THAT CANARY CALL.

Doubt is expressed by an Irish contemporary as to whether the canary interval

1,071 metres. According to the Prague Plan, this wavelength is allotted to the Norwegian relay station at Trondjhem, but, as the station will not be completed for service until April or May, the wavelength is being "borrowed" by the Dutch stations Hilversum and Huizen.

What will happen when Trondjhem leaps into life is a little problem best left to the Union Internationale de Radiofusion.

○○○○

#### WIRED WIRELESS IN CANADA.

A new land line, 300 miles long, is being installed between Oshawa and Sudbury (Northern Ontario) by the Bell Telephone Company of Canada, to be operated on the "wired wireless" principle. This will make it possible for eight persons to converse at one time over the same pair of wires, or for two people to talk and forty people to be in communication on teletype or telegraph simultaneously.

Construction will be completed in a year from the beginning of operations,

## Catalogues Received.

Runbaken Motor & Electrical Accessories, Ltd., Magnet Works, Ardwick, Manchester.—80-page illustrated catalogue of electrical equipment. A section is devoted to battery chargers.

○○○○

Messrs. W. and G. Foyle, Ltd., the well-known booksellers of 119-125, Charing Cross Road, London, W.C.2, have issued a useful catalogue of new and second-hand books on all technical subjects and applied science, from aeronautics to water analysis and supply, including electricity and electrical engineering. We can recommend this list to readers, especially to those on the look out for special, out-of-print, or other rare books.

○○○○

Messrs. Lissen, Ltd., Lissenium Works, Worple Road, Isleworth, Middlesex.—Illustrated and descriptive literature of Lissen radio components, valves, loud speakers, and gramophones. Also constructors' broadsheet for building the Lissen "Screened Grid Three" receiver.

○○○○

The Record Electrical Co., Ltd., Broadheath, Manchester.—Descriptive folder dealing with the Record Bridge Ohmmeter, a combined ohmmeter and Wheatstone bridge for insulation testing and measuring resistances of from 0.01 ohm to 999,900 ohms.

# Multi-Range



## Meter Conversions

Extending the Scale of D.C. Instruments.

By W. A. BARCLAY, M.A.

*Our contributor, whose research work in connection with various problems of reception is so well known to readers of our sister journal "Experimental Wireless," deals here with the surprising utility range of the D.C. moving-coil milliammeter, and supplies a valuable abac.*

THERE is no instrument which is so universally serviceable to the wireless worker as a sensitive and accurately calibrated milliammeter. The uses of the D.C. moving-coil meter are legion and need not be enumerated here. Not the least among its advantages is the fact that it is possible to use it as voltmeter or ammeter at will over widely differing ranges of voltage and current.

The question is often put by beginners as to how the same instrument may be used for two such different purposes as to measure voltage and current. Happily, the answer may be found without much mathematics by the aid of that "Pons Asinorum" of electricity, Ohm's law. A current-measuring device such as a milliammeter necessarily has a small internal resistance, the smaller this resistance the more sensitive being the instrument. This resistance,  $R$  ohms, let us say, remains the same no matter what the deflection of the needle, i.e., no matter what the current passing may be. If, then, our milliammeter needle is fully deflected when a current of 5 milliamps. is flowing, we can see by Ohm's law that there must exist a potential difference of  $5R$  millivolts between the terminals of the instrument. If, to take an actual case, the internal resistance  $R$  of the meter is 20 ohms, then if 5 milliamps. causes full-scale deflection the potential across the terminals will be 0.1 volt. Smaller voltages will, of course, give lesser readings in proportion, i.e., our milliammeter is also a voltmeter, and may be used directly to measure voltages up to this amount.

Although 0.1 volt is the highest E.M.F. it is possible to apply to the terminals of this instrument with safety we can utilise it to measure E.M.F.s of much greater amount in an indirect way. If, for example, it is desired to measure voltages up to 1 volt, we should

employ the circuit of Fig. 1a, in which an external resistance of  $\rho$  ohms is placed in series with the meter. Since 0.1 volt is all that we can apply across the meter to ensure full-scale deflection it is obvious that the value of  $\rho$  must be so chosen that the remaining 0.9 volt is dropped across it. It will be seen that in the case considered this external resistance must have nine times the value of the meter resistance, i.e., 180 ohms. Generally, if the meter by itself reads up to  $V_1$  volts, and it is desired to extend the range to measure up to  $V_2$  volts, the value of the external series resistance  $\rho$  required may be found from the formula

$$\rho = R \left( \frac{V_2}{V_1} - 1 \right),$$

$R$  being the internal resistance of the meter.

Again, if the instrument is considered in its simplest aspect, that of a low-reading milliammeter, it is easy to see that it may be used to measure much larger currents than would be possible directly by shunting the meter with a resistance whose value is generally small compared with that of the internal resistance of the meter. In the case of the instrument considered above, full-scale deflection of the needle occurs for a current of 5 mA. Suppose now it were desired to measure currents up to a maximum of 50 mA.; for a full-scale reading on the instrument

it would be necessary to shunt the balance of 45 mA. through the parallel resistance.

Since this parallel current has nine times the value of the meter current it will be seen that the value of the shunt would require to be one ninth of the internal resistance of the meter, or 2.22 ohms. Generally, if the meter by itself reads up to  $A_1$  milliamps., and it is desired to extend the range to measure up to  $A_2$  milliamps., the shunt resistance  $S$  to be included

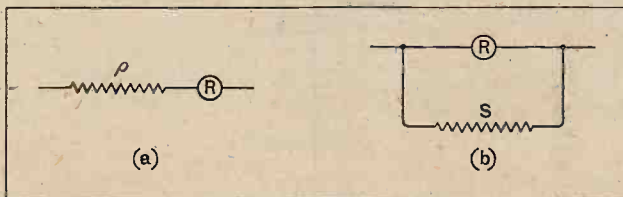
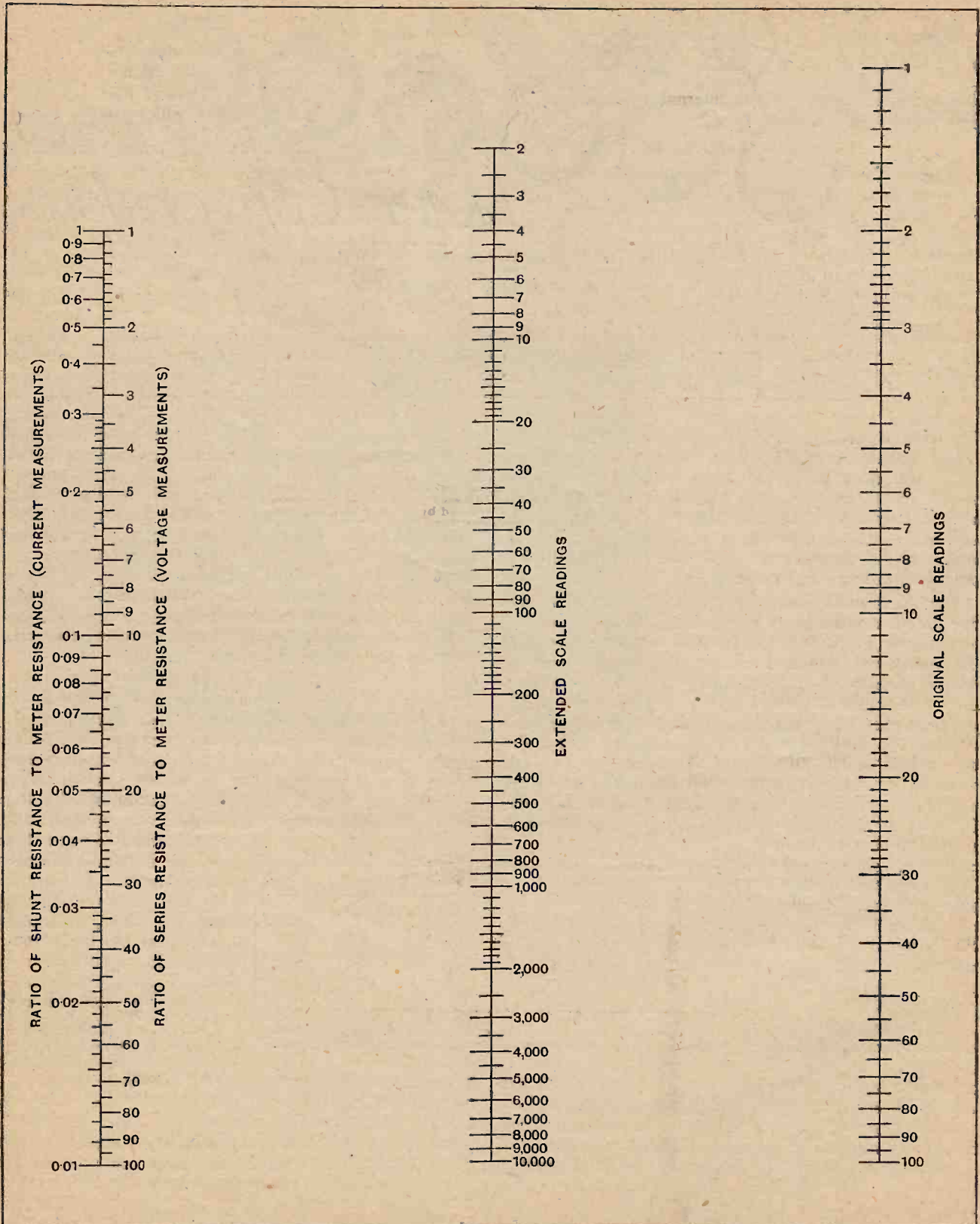

Fig. 1a.—Voltmeter connections with series resistance. Fig. 1b.—The shunt resistance connection for extending the ampere scale.

Handwritten notes:  $\frac{11}{50} \times \frac{2}{9}$



This chart gives the value of resistance required in order to extend the range of an ammeter or voltmeter.

Multi-range Meter Conversion.—  
is found from

$$S = \frac{A_1 R}{A_2 - A_1}$$

where  $R$ , as before, is the internal resistance of the instrument.

**A Graphical Illustration.**

A graphical illustration of the manner in which the range of voltage- and current-measuring instruments may be related to the auxiliary series and shunt resistances employed with them will now be given. In the case of the voltmeter (Fig 2a), let the distance  $OA$  represent the internal resistance  $R$  of the instrument, and  $OB$  the extra resistance  $\rho$  to be used in series with it. Let  $OC$ , drawn perpendicularly to  $AB$ , represent the original full-scale meter reading  $V_1$  in volts. Join  $A$  to  $C$ , and produce it to meet the vertical through  $B$  in  $D$ . The length  $BD$  will now represent (to the same unit as  $OC$ ) the new full scale of the voltmeter readings  $V_2$  for the external resistance  $\rho$ .

Similarly, in the case of the ammeter (Fig. 2b), let  $OA$  represent, as before, the internal resistance  $R$  of the instrument, while  $OB$  is now the shunt resistance  $S$  to be included. Let  $OC$  be now drawn perpendicularly to represent the original full-scale reading  $A_1$  in milliamps. In this case  $B$  is joined to  $C$ , and produced to meet the vertical through  $A$  in  $D$ . The length  $AD$  now represents the new full scale of ammeter readings  $A_2$  for the particular shunt resistance  $S$ .

**An Alignment Chart.**

For those experimenters who desire to have a rapid means of correlating meter readings with auxiliary resistances, the alignment chart has been prepared. In this chart it is found convenient to dispense with the actual values of the auxiliary resistances and internal meter resistances, substituting instead the ratios of the

former to the latter. By his means a greater degree of generality is obtained over a wider range of auxiliary resistances than can be conveniently exhibited on the diagrams of Figs. 2a and 2b. The method of use will be familiar to readers of *The Wireless World* from the series of Useful Data Charts which have already appeared in the pages of this journal.

The centre and right-hand support lines carry values which may represent either current or voltage readings; the left-hand support gives the ratios of the auxiliary resistances to the internal resistance of the meter. It will be observed that this left-hand support carries two scales; that to the outside gives the ratio  $S/R$  when current extension readings are in question, the inside one giving values of  $\rho/R$  when dealing with voltage extension readings.

Let us take, as an example of the use of the chart, the case of the milli-ammeter cited above which registers full-scale deflection for a current of 5 mA., and which it is desired to

extend to read to 50 mA. Joining these two values on the right-hand and centre scales of the chart, it is found that the index line cuts the left-hand scale at the value  $S/R = 0.111$ , so that the shunt must be 0.111 times the value of the internal resistance.

The chart, of course, gives approximate values only. The practical work of rigging up and calibrating an accurate multi-range volt-ammeter calls for skill on the part of the constructor. Much care is needed, for example, to ensure that the small shunt resistances for the different ammeter ranges are of the correct values. For this reason anything in the nature of a multi-stud switch for the purpose of placing such resistances in circuit is to be deprecated, as such devices are apt to introduce unwanted resistance which might seriously affect the readings of the instrument.

Readers who wish to pursue the subject in greater detail should consult the admirable article by E. H. W. Banner, M.Sc., which appeared in *Experimental Wireless* of February, 1925.

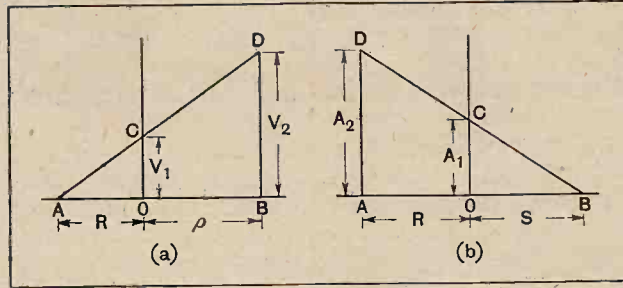

Fig. 2a.—Extended range  $V_2$  of voltmeter may be increased by the use of the larger series resistance  $\rho$ . Fig. 2b.—Extended range  $A_2$  of voltmeter may be increased by diminishing the value of the shunt resistance  $S$ .

**Short-wave Tests—**

The Radio Society of Great Britain asks its transmitting members to take part in the series of tests on the 28,000 kc. waveband on March 2nd, 9th, 16th and 23rd, when it is intended to run continuous tests for the full 24 hours on each day.

The main objects are to determine if simultaneous reception of distant stations is obtained at different places in Great Britain; the comparative effectiveness of low power and high power; the suitability of various transmitting circuits; the practical value of H.F. amplification and the possible relation between solar and mag-

**TRANSMITTERS' NOTES.**

netic conditions and propagation. Full particulars can be obtained from the R.S.G.B., and reports should be sent to Mr. R. W. Leader (G 5VL), at Porth, St. Columb Minor, Cornwall, who is offering a challenge trophy for yearly competition.

**—And 2,000 kc. Tests.**

It is also proposed to conduct a series of tests on the 2 megacycle waveband during April, but we understand that the

details and conditions are still under discussion. We pointed out last week that transmissions on the 7 mc. band are suffering considerably from interference by badly rectified A.C., and it is hoped that these tests may convert the sufferers to the lower frequency bands.

o o o o

**The Prime Minister's Speech.**

We understand that many listeners were disappointed in being unable to pick up Mr. Ramsay MacDonald's speech to America on January 22nd as 5SW was using a special wavelength which was kept secret.



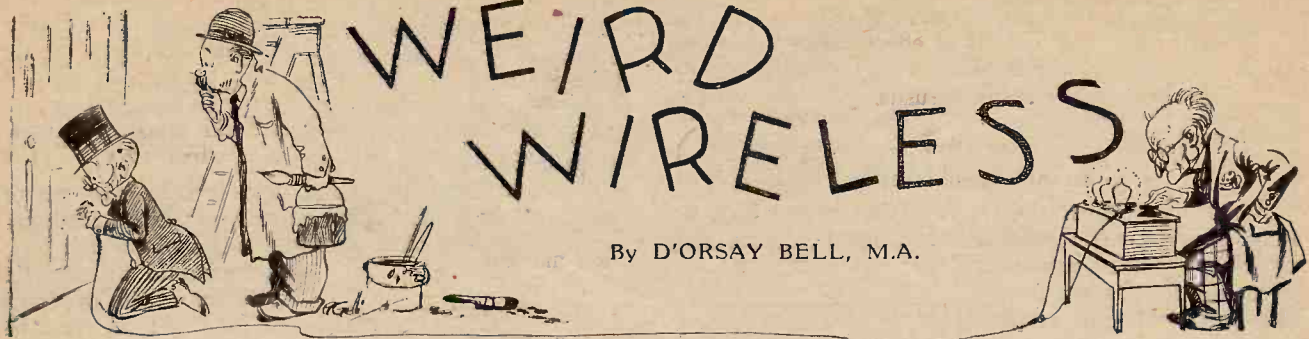

By D'ORSAY BELL, M.A.

## Blazing New Trails in Radio Research.

NO, it is *not* a misprint for "Wired," as you thought it was. Weird Wireless, as opposed to the ordinary forms of radio (wireless telegraphy, wired wireless, television and so on) about which the readers of this journal know most that is worth knowing, is that large branch of radio about which they know nothing. Do I realise what I am saying? I do. Am I not giving utterance to an unwarrantable and gratuitous piece of impertinence? I am not.

I have never, for instance, come across any animated correspondence in these pages on the subject of Paint and Varnish Radio. And yet paint and varnish radio is a very important—an increasingly important—subject. The research laboratories of big P. and V. manufacturing concerns are studying, by radio technique, the effects which heat and cold, oxidation and so on, produce on their latest products. Particularly useful here is what might be called an "ultra" edition of the Ultra-micrometer. If two circuits, each kept oscillating by a valve, are almost but not quite in tune and are carefully coupled together, the very least change in tune in the one will produce a great change in current in the other. In the Thoma variation of the ultra-micrometer, a slight increase in the thickness of a paint film alters the capacity of a condenser, brings about an infinitesimal change of tune in one circuit, and gives such a magnified result in the other circuit that the change in the thickness of the film can be recorded and studied very easily.

**Robots: Efficiency 500 per cent.**

It is said that this new "tool" is enabling the research people to investigate the why and wherefore of important actions going on in their paints, the very existence of which was unknown till now. But this is only

one way in which wireless technique is being used in the paint industry. There is a most attractive, super-human gadget which analyses the colours of paints (and writes down the results) quite automatically and five times as accurately as can be done by the human eye. The machine flashes a beam of light (red, for instance) backwards and forwards between the sample under test and a standard colour. If the red beam is reflected more by the standard than by the sample, the result—thanks to the help of a photoelectric cell such as is used in photo-telegraphy and television—is a pulsating current. This, after passing through valve amplifiers, sets a little motor buzzing round and altering things so that the red beam now divides its attention between the sample and a second standard colour: if this does not correspond exactly to the sample, the motor keeps on buzzing round and tries a third standard, and so it goes on till a standard is encountered which gives an exactly equal reflection. When this happens, there is no pulsating current to drive the motor, which comes to rest with a feeling of duty well done. The machine makes a note of that particular standard, switches on a test beam of another colour, and the whole process goes on all over again. The complete colour analysis takes only a few minutes, which is far quicker than can be done by human beings.



Upsetting the grid circuit.

**And Meanwhile, in the Vast Open Spaces . . . .**

Let us leave the stuffy laboratory and get into the vast open spaces of America, Canada and Australia. Here, screen-heroes in khaki shirts and shorts are busily using short-wave valve generators to explore for oil and minerals. Various methods are used, but one favourite plan is to compare the velocity of sound waves through the ground with that of short radio waves. The latter

**Weird Wireless.**—

keep their velocity constant, while the sound waves vary theirs according to the nature of the soil: the presence of oil, in particular, has a marked effect. For minerals, the method usually employed involves the use of direction-finding loop aerials—plus the usual valve amplifiers.

**Mutual Interference.**

In fact, practically the whole resources of modern wireless are being concentrated on the unwarrantable spying-out of these harmless and carefully concealed minerals, oils, and so on. It is pleasant to be able to relate that occasionally the victims get a bit of their own back: it is reported from Wiesbaden that listeners-in have been worried by a strange kind of interference, rather like atmospherics but more regular, and this has now been found to come from the radio-active mineral springs under the town. Perhaps that will teach people to let well—and spring—alone. Which reminds me: I ended my last article with a suggestion, more or less flippant and for the sake of a neat ending, that perhaps hazel-twig water-divining was only another branch of wireless. As a result of this remark a correspondent has kindly referred me to an article in the sedate pages of *Nature*, in which a researcher describes a series of tests leading to the following conclusions:—that the faculty of water-divining is possessed by some individuals; that these individuals respond to some at present unknown stimuli; and that these stimuli can be cut off by the interposition of certain substances: for instance, if one leg of the twig has a bit of rubber tubing slipped over it, thus insulating one hand from the twig, the phenomena cease (=a break in the loop aerial? Weird Wireless!)

**A Ceaseless Stream of Development.**

But since the Editor will only give me a miserable page or two, I must be much briefer than this if I am to keep anything like up to date. For every day seems to bring fresh developments which clamour for notice. Piezo-electric quartz, that high-brow laboratory phenomenon which was so promptly seized on to keep radio transmitters to their proper wavelength, is now being used to register variations of pressure in water-mains: so is the effect of capacity change on a heterodyne note, one plate of a condenser being forced in towards its second plate by any increasing pressure. The photo-electric cell—direct descendant of Elster and Geitel's "academic" experiment where light falling on to a spark-gap stopped the spark—is now used for about as many purposes as an Austin Seven. Apart from its jobs in picture telegraphy and television, it counts the traffic passing through the big tunnel joining New York to New Jersey; it judges the winning horse in a race; it sorts and counts mass-produced goods; it is used in chemical works to decide when enough alkali—

for instance—has been added to complete a reaction (some of you may remember the titration tests at school, when the critical last drop suddenly wiped away every trace of colour from a whole big flask-full of coloured liquid; the photo-electric cell watches for this, and when it happens, turns off the tap). It, as well as its brother the selenium cell, is used as a burglar alarm; another burglar alarm, by the way, is one in which the action—or the mere presence—of the burglar upsets the tuning of the grid circuit of an oscillating valve and causes an anode-current change which works a relay. The condenser-microphone, which some engineers swear by for broadcasting, is now being used by doctors to give them a record of their patients' heart-beats. Thanks to the valve amplifier, the tiny resistance-changes in the human body, due to emotion of various kinds, can now be recorded—and this procedure, it is said, is going to be very valuable in studying the effects of drugs and in investigating nervous fatigue. Noises in gear boxes, ball bearings and other machinery, and noises indicating insulation trouble and the consequent danger of breakdown in big transformers, are being tracked down by microphone and valve amplifier: the ordinary, normal running noises being filtered out by electrical filters such as are used in wireless, so that the trouble-noises can be distinguished.

**Flaws in Metals.**

Flaws in steel axles are now being looked for by rotating the axle rapidly and exploring with an instrument rather like the magnet arrangement of a telephone receiver—the disturbances induced in the telephone

windings by the presence of a flaw rapidly passing by are detected after amplification in the usual valve amplifier. A similar process is applied to steel wire ropes—but here the rope remains still and the magnetic flux rotates. Think of the accidents which may arise from flaws in axles and wire ropes, and you see how beneficial to man are these new applications of radio technique.

At least one company exists in America for testing railway lines for flaws and other defects in the rails: it provides a specially equipped railway truck which runs over the track at about five miles an hour. Two brushes, a little distance apart, continually conduct direct current to and from the bit of rail between them. Half-way between these main brushes is a trio of searching brushes connected in a kind of push-pull way to a transformer. The secondary of this transformer goes to a four-valve amplifier which works various relays, and when any kind of flaw upsets the symmetry of the current flowing in the rail, these relays do their work—they sound a warning buzzer, record the exact position on a travelling tape, and even go so far as to spray a blob of paint on to the offending bit of rail. Having done all this they send off a wireless message to H.Q., sacking the foreman responsible for laying that bit of rail . . . and that is the only bit of exaggeration this article contains.

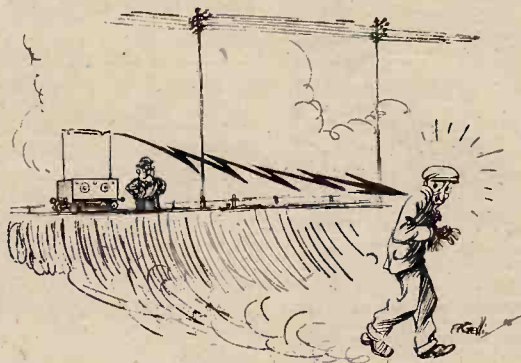

Sacking the foreman.



Part XVIII.—Dynamic Resistance of Tuned Circuits.

By S. O. PEARSON, B.Sc., A.M.I.E.E.

(Continued from page 74 of issue dated January 15th.)

IN dealing with the parallel type of tuned circuit in the last issue we arrived at the important conclusion that, when tuned to resonance, the circuit behaves like a pure resistance of  $L/CR$  ohms, where  $L$  is the inductance of the coil,  $C$  is the capacity of the condenser and  $R$  the "equivalent series resistance" within the

connected in parallel with a condenser of 0.00025 microfarad capacity. The dynamic resistance will be

$$R_D = \frac{L}{CR} = \frac{2,532}{0.00025 \times 50} = 202,000 \text{ ohms.}$$

(Note that it is not necessary to convert microhenrys to henrys and microfarads to farads in any formula where  $L$  and  $C$  form a ratio.)

This is the maximum impedance of the circuit, and in designing a tuned circuit the object in view is to obtain the highest possible dynamic resistance. The

ratio of  $\frac{L}{C}$  should be chosen as high as practical con-

siderations will allow, and the coil resistance should be as low as possible. Now, in practice there are always losses, not only within the closed circuit itself, but associated with it due to connected apparatus, induced currents in neighbouring circuits and objects, and due to actual radiation. All of these go to reduce the

dynamic resistance of the circuit or to increase the equivalent series resistance. For instance, suppose that the tuned circuit LRC of Fig. 1 (a) is, in effect, shunted by a resistance of  $r$  ohms due to some connected apparatus. The arrangement would then be as shown in Fig. 2 (a), being a circuit having both series resistance  $R$  and shunt or parallel resistance  $r$ . But we have already seen that the series resistance  $R$  has the same effect as a shunt resistance of  $L/CR$  ohms at the resonant frequency, and so the circuit of Fig. 2 (a) may be replaced by Fig. 2 (b).

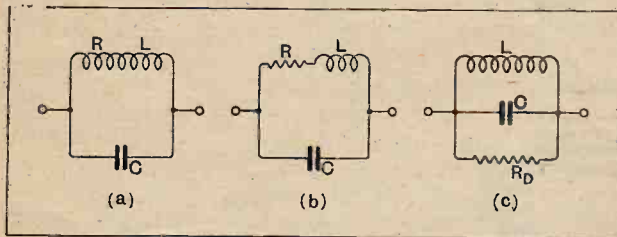

Fig. 1.—(a) Tuned parallel circuit with effective resistance  $R$  in the coil. (b) Equivalent circuit with internal resistance. (c) Equivalent circuit with whole of the resistance imagined in parallel. The equivalent parallel resistance is the dynamic resistance of the circuit.

closed loop itself. The value  $L/CR$  ohms was referred to as the "dynamic resistance" of the tuned circuit, and can be defined as the resistance measured between the ends of the circuit when accurately tuned to resonance, because under these conditions the current is exactly in phase with the applied voltage.

In Part XVI it was shown that a circuit consisting of a perfect condenser in parallel with a resistanceless coil would allow no current to pass to and from the circuit at the resonant frequency; that is to say, for such a circuit the dynamic resistance would be infinitely great. Now, a practical circuit having an effective series resistance of  $R$  ohms, as shown in Fig. 1 (a), is equivalent to circuit (b) at any frequency; but at the resonant frequency it is also equivalent to a perfectly resistanceless tuned circuit shunted by a pure resistance of such a value that the current is the same as that taken by the actual circuit. This equivalent circuit is shown at (c) in Fig. 1, and the equivalent parallel resistance represents the dynamic resistance of the tuned circuit, its value being  $R = \frac{L}{CR}$  ohms.

Numerical Values.

As a numerical example, suppose that a tuned circuit consists of a coil whose inductance is 2,532 microhenrys and whose high-frequency resistance is 50 ohms, con-

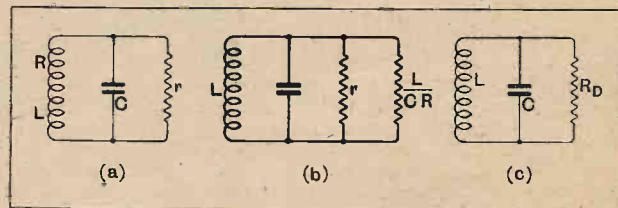

Fig. 2.—(a) Shunted tuned circuit. (b) and (c) Equivalent circuits.  $R_D$  is the resultant dynamic resistance and is given by  $\frac{1}{R_D} = \frac{1}{r} + \frac{CR}{L}$ .

Here we have a resistanceless tuned circuit shunted by the equivalent of two resistances  $r$  and  $L/CR$  ohms in parallel. The combination of these two resistances is the dynamic resistance of the tuned circuit of Fig. 2 (a).

If  $R_D$  is the dynamic resistance, then  $\frac{1}{R_D} = \frac{1}{r} + \frac{CR}{L}$ .

**Wireless Theory Simplified.**

Thus in its simplest form the equivalent circuit reduces to the arrangement of Fig. 2 (c) where  $R_D$  is the resulting dynamic resistance.

For the coil and condenser considered above the value of  $L/CR$  was found to be 202,000 ohms, or 0.202 megohm. Now, suppose that this circuit is shunted by a resistance of 500,000 ohms or 0.5 megohm. The dynamic resistance of the complete circuit will

$$\text{then be given by } \frac{1}{R_D} = \frac{1}{0.5} + \frac{1}{0.202}, \text{ or } R_D = \frac{0.5 \times 0.202}{0.702} =$$

0.144 megohm = 144,000 ohms. Thus the addition of the half-megohm resistance in parallel has reduced the dynamic resistance by about 30 per cent.

**Comparison of Series and Parallel Circuits.**

Comparing the series-tuned circuit with the parallel circuit we find that at the resonant frequency the former has its minimum impedance whereas the latter has its maximum impedance. Furthermore, the series circuit, where the energising voltage is injected into the closed circuit itself, has the property of giving a voltage magnification or step-up effect; but with the parallel circuit the voltage is impressed between its ends and no voltage magnification can possibly be obtained. As regards selectivity the two circuits obey similar laws, but are used under entirely different conditions. For instance, the series circuit, on account of its very low impedance at the resonant frequency (its value being equal to the effective resistance in the closed circuit itself), is usually found in places where the remainder of the circuit, of which it is a part, has low impedance or where it is independent of other circuits altogether. As a case in point the ordinary tuned grid circuit inductively coupled to the aerial or other source of alternating E.M.F. was referred to in a previous section dealing in detail with the properties of tuned circuits.

The parallel circuit, on the other hand, has a very high impedance at the resonant frequency compared with its impedance at other frequencies, and is therefore always to be found in places where the rest of the circuit, in series with it, has a high resistance or impedance. The commonest example is the ordinary tuned-anode circuit where the A.C. resistance of the valve between the anode and cathode or filament constitutes the high resistance in series with the tuned circuit.

**How a Parallel Tuned Circuit is Employed.**

Since the tuned parallel circuit is incapable of giving any voltage step-up effect at the resonant frequency, it could not possibly have any selective properties unless used in conjunction with a series resistance in this manner, where the series resistance is more or less independent of frequency.

In order to see exactly how the presence of a series resistance of fixed value introduces selective properties,

let us consider the circuit of Fig. 3 (a), where LRC is the tuned portion whose impedance depends on the frequency, and  $R_1$  is a fixed non-inductive resistance independent of frequency.  $R$  is the effective resistance within the closed loop. Suppose that an alternating voltage whose R.M.S. value is  $E$  and whose frequency is  $f$  cycles per second is applied to the ends A and B of the circuit. Now, when the closed loop LRC is tuned to complete resonance with the applied frequency this part of the circuit is equivalent to a non-inductive resistance of  $L/CR$  ohms, this being the dynamic resistance  $R_D$ , and is in series with the fixed resistance  $R_1$ . Thus the circuit as a whole behaves like a simple arrangement of two resistances in series, the total resistance being  $R_1 + R_D$  ohms, as shown by Fig. 3 (b). The R.M.S. value of the current is obtained simply by dividing the voltage  $E$  by this resistance.

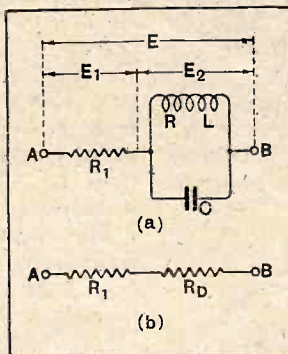

Fig. 3.—(a) Tuned circuit in series with a fixed resistance. (b) Equivalent circuit at the resonant frequency;  $R_D = \frac{L}{CR}$  ohms.

Let  $E_1$  be the voltage set up across the series resistance  $R_1$ , and  $E_2$  the voltage across the tuned portion LRC. Then by Ohm's law  $E_1 = IR_1$  and  $E_2 = IR_D$  volts where  $I$  is the current. Each of these voltages is in phase with the current, and therefore they are in phase with each other. This means that the total voltage  $E$  applied to the ends of the circuit is equal to the numerical sum of  $E_1$  and  $E_2$ , just as though it were a simple D.C. circuit; and, further, that the applied

voltage is divided between the two portions of the circuit in the direct ratio of their equivalent resistances; that is to say,  $E_1 = E \frac{R_1}{R_1 + R_D}$  and  $E_2 = E \frac{R_D}{R_1 + R_D}$  volts at the resonant frequency.

A numerical example will make this clear. Suppose that  $L = 2,532$  microhenrys,  $C = 0.00025$  microfarad and  $R = 50$  ohms as before. Then the dynamic resistance at the resonant frequency is 202,000 ohms. Suppose, further, that the series resistance  $R_1$  has a value of 20,000 ohms and that the voltage applied to the ends of the circuit between A and B is 10 volts. The total resistance of the circuit when accurately tuned is  $202,000 + 20,000 = 222,000$  ohms and the current through it will be  $\frac{10}{222,000}$  ampere. Thus the voltage across the

tuned circuit will be  $E_2 = I \times R_D = \frac{10}{222,000} \times 202,000 = 9.1$  volts. That is to say, 91 per cent. of the available 10 volts applied is set up across the tuned portion LRC of the circuit, the remaining 9 per cent. existing across the series resistance  $R_1$ .

At any other frequency, different from the resonant value, the impedance of the loop LRC is a great deal less than  $L/CR$  ohms, and therefore a very much smaller proportion of the total voltage is set up across it. In tuning the circuit to resonance the chief aim is to get the highest possible fraction of the total available voltage to be set up across the tuned portion and as little as possible across the series resistance  $R_1$ , which would normally constitute the internal resistance of a

**Wireless Theory Simplified.—**

valve. Hence for good selectivity the value of the dynamic resistance  $L/CR$  ohms at the resonant frequency must be large compared with the series resistance  $R_1$ , whereas at other frequencies the impedance of the portion LRC should have a low value. This subject will be dealt with in greater detail when we come to the discussion of actual valve circuits.

The resonant frequency of the circuit considered above

$$f = \frac{1}{2\pi\sqrt{LC}} = 200 \text{ kilocycles per second.}$$

Suppose now that the frequency of the applied voltage is increased to 210 kilocycles per second without changing the tuning of the circuit. The impedance of the tuned portion will now be  $Z_2 = 32,200$  ohms, and, incidentally, the voltage across it will no longer be in phase with the current passed by the circuit. Thus for a 5 per cent. increase in frequency the impedance of the tuned portion of the circuit is reduced from 202,000 ohms to

<sup>1</sup>The impedance of a parallel circuit of this type is given at any frequency  $f$  by

$$Z_2 = \frac{Z}{\sqrt{R^2 + (\omega CZ_1^2 - \omega L)^2}} \text{ ohms,}$$

where  $\omega = 2\pi f$  and  $Z_1$  is the impedance of the coil itself at the frequency  $f$ .

32,000 ohms, and therefore the ratio of the voltage across this part to the voltage across the series resistance

$R_1$  is now only  $\frac{32,000}{20,000}$  or 1.61. At the resonant frequency of 200 kilocycles per second the voltage across the loop circuit was seen to be just over 10 times as great as that across the series resistance, whereas at 210 kilocycles per second it is only 1.61 times as great.

These figures emphasise the fact that the parallel type of tuned circuit is highly selective when used in conjunction with a series resistance if the dynamic resistance of the tuned portion is high at the resonant frequency. In the ordinary tuned-anode circuit the object in view is to get as large a proportion of the wanted signal voltage as possible across the tuned circuit, losing as little as possible across the internal resistance of the valve. On the other hand, any unwanted signals of a different frequency or wavelength must be "lost" as far as possible in the internal resistance of the valve in the manner indicated above.

The opportunity is here taken of correcting an error which occurred in Part XV of this series. The second line of the second paragraph on page 24 should read—the external resistance  $r$  is  $\frac{E_c^2}{r}$  watts.

(To be continued.)

**LOTUS DRUM VERNIER DIALS.**

These drums are supplied as single units or in dual form for semi-ganging two-tuned circuits. The drum dial is standard in both models, the principal difference being in the shape of the condenser support and escutcheon plate. An epicyclic friction gear is employed, giving a reduction ratio of 10:1. The dial runs smoothly and without a trace of slip or "lumpiness." There is no backlash.

The driving disc is 4 in. in diameter,  $\frac{7}{8}$  in. thick and provided with a milled edge. An ivory scale  $3\frac{1}{2}$  in. in diameter and  $\frac{5}{16}$  in. wide is fitted and engraved 0-180. Provision is made to accommodate a  $\frac{1}{4}$  in. condenser spindle, a small grub screw serving to position the dial.



Lotus single- and dual-drum Vernier dials.

The single and dual units can be obtained fitted with oxydised silver, bronze-finished metal escutcheon plates, or moulded-type can be had if required. These are in black or mahogany bakelite. The price of the single unit is 9s., the dual assembly being offered at 18s. The makers are Garnett, Whiteley and Co., Ltd., Lotus Works, Mill Lane, Liverpool.

**NEW  
APPARATUS  
REVIEWED.****COMBINED LAMP HOLDER AND  
PLUG-POINT.**

A cleverly designed lamp holder embodying a plug-point to which can be attached a battery eliminator, or domestic electric device, has been placed on the market recently by Wm. Beardsall and Co., Ltd., Victoria Bridge, Manchester, at the attractive price of 4s. 6d. There is no exposed metal, either "live" or otherwise. The body consists of a cleanly moulded bakelite shell carrying the usual bayonet-type lamp holder at one end and a cord-grip fitting at the other. The two-pin plug makes contact direct with the mains leads and not via the lamp plungers and springs. This is a point of some importance should the additional electric device demand a relatively heavy current. Massive contacts are provided, and these are rated to carry 5 amperes. It has not been thought necessary to fit a switch to control the extension point; removing the plug serves this purpose. A portion of the metal on one pin of the plug has been removed and the cavity filled in with some special insulating material. The contact points inside the holder are arranged so that on reversing the plug the lamp circuit is broken but without affecting the supply to the extension circuit. It is at once obvious that controlling the lamp by this means is pos-

sible only where A.C. is available—for battery eliminators or charging—or when the additional electric device operates irrespective of polarity. Reversing the

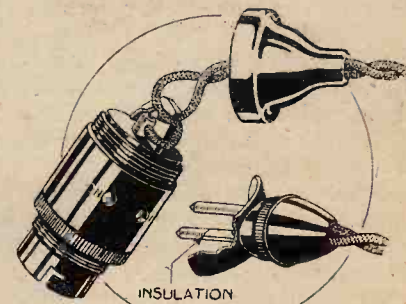

"Xtra-Point" lamp holder. It is shrouded in bakelite and fitted with two-pin plug for extension lead. Can be used to supply a battery eliminator.

plug changes the polarity of the supply on the extension leads. This useful accessory has been given the appropriate designation "Xtra-Point" lamp holder and plug.

o o o o

**R.G.D. PICK-UP AND TONE ARM.**

Made by the Radio Gramophone Development Co., St. Peter's Place, Broad Street, Birmingham, this unit forms an essential component of this firm's radio-gramophone equipment. The external appearance is particularly neat and businesslike, and the overall height is only  $1\frac{1}{2}$  in., so that it can easily be accommodated under the shallowest cabinet lid. The tone arm is of hollow rectangular

section and is of negligible weight, and the pick-up unit is attached at such an angle that tracking errors are reduced to a minimum. The tone arm is extensible, giving a variation in length of about 1in.

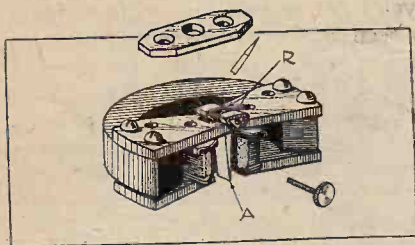

Component parts of the R.G.D. pick-up. (A) armature. (R) rubber mounting.

The pick-up movement is sound in principle. The armature is kept down to the smallest possible dimensions and is mounted between the pole pieces in such a manner as to give differential variations of the flux surrounding the pick-up coil. Adequate control of the movement is obtained by clamping the knife-edge pivot between rubber packing. The needle set-screw passes through the axis of the pivot and its moment of inertia is therefore negligible.

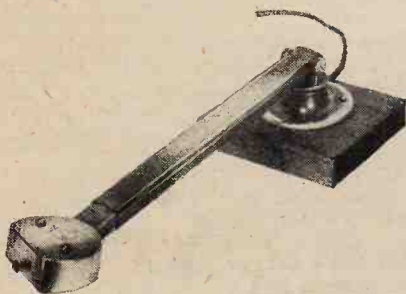

The R.G.D. pick-up and tone arm.

The characteristic shows these principles of design to be justified, for the output is practically constant from 250 to 1,500 cycles. The principal reed resonance occurs at about 3,000 cycles, which is near the upper limit of fundamental frequencies

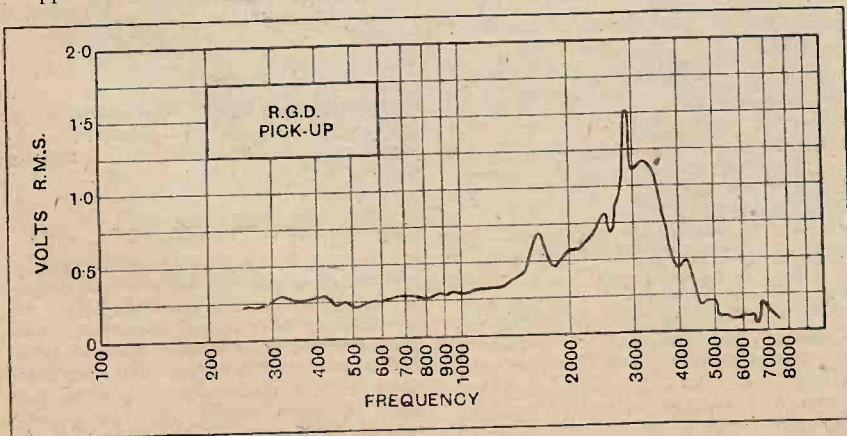

Voltage output characteristic of the R.G.D. pick-up and tone arm.

in common use. No objectionable resonance could be detected by ear when playing ordinary records.

A few readings taken below 250 cycles showed that the characteristic rises slightly, but not sufficiently to correct deficiencies in the average record. An improvement could be effected here by decreasing the air gap to the smallest value consistent with manufacturing difficulties and freedom from chattering, as this would improve the output at low frequencies where the amplitude is large.

However, taking a general view, this pick-up is well above the average in performance and in use possesses a noticeable freedom from producing record wear.

The price finished in bronze is £3 and in oxydised silver £3 3s.

o o o o

**NEW COLVERN RESISTANCES.**

With the rapid developments now taking place in the design of mains-operated sets the demand for resistances has enormously increased. In an all-mains A.C. receiver there may be more than half a dozen different resistances all capable of carrying a generous current and accurate to within narrow limits. To meet the need for an inexpensive component, Colvern Ltd., Mawney's Road, Romford, Essex, have developed a new series of wire-wound resistances carried on glass tubes measuring 3 x 1/2 in. diameter. The wire, which is nickel chrome, is accurately space-wound as a single layer. The winding is terminated on metal bands, and a hard covering of bakelising material renders the resistance durable. To avoid the use of several series-connected resistances, tapping points are arranged by the use of additional clips. It is to be noted that with this form of winding the capacity from end to end of the resistance is exceedingly low, an important requirement when a resistance is used for the purpose of isolating H.F. circuits. Even with the highest value resistances the turns of wire are generously spaced.

The standard sizes advance in steps of 10,000 from a minimum of 10,000 to a maximum of 100,000 ohms, intermediate and higher values being supplied to order.

The rating of the resistances is 10 watts, but on test it was found that 15 watts could be dissipated across a 50,000-ohm resistance without excessive temperature rise. A current of 10 mA. is safely passed by the 100,000-ohm resistance, and as 1,000 volts is required to produce this

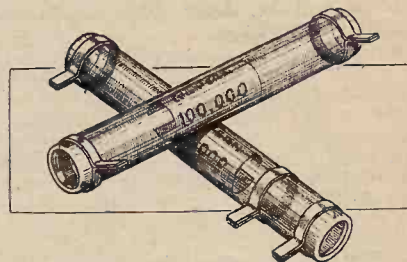

New type Colvern resistances designed for use in mains-operated sets and eliminators.

current it is obvious that in ordinary use the resistance cannot be overrun. Small bent metal sockets are used for fixing, the connections being soldered direct to the clip on the resistances.

In sizes up to 50,000 ohms the price is 2s. 6d., and 50,000-100,000 ohms, 3s. 6d. Tapping points are provided to order at 1s. extra.

o o o o

**T.C.C. CONDENSERS.**

A new process of manufacture has enabled the Telegraph Condenser Co., Ltd., Wales Farm Road, North Acton, London, W.3, to make a considerable reduction in the size of some of their well-known types of large-capacity condensers



Remoulded T.C.C. 4 mfd condensers. Note the generous size of the terminals.

intended primarily for use in high-voltage battery eliminators. This applies particularly to the 4 mfd. 800-volt D.C. test models. It has been found possible to reduce the physical size by half without impairing the quality of the condenser. The working pressure is 400 volts D.C., and the price is 8s. 6d. Large-size terminals, well insulated from the metal container, are fitted.

The 400-volt D.C. test models are now fitted in moulded bakelite cases provided with two sets of fixing lugs, thus allowing for either upright or sideways mounting. Large terminals are fitted to this model also. The type illustrated is a 4 mfd. size, working voltage 200 D.C., and the price is 6s. 3d.

# BROADCAST BREVITIES

## Regional Perplexities.

"You are wrong," wrote a listener to Savoy Hill last week. The Technical Correspondence Department had told him that the 261-metre transmission would come in better if he tried changing his present dial setting from 36 to about 24. "You are wrong. I find the correct setting is 22."

o o o o

## A Clean Start.

This is the sort of client (and there are many of them) who has driven the engineers to yet another literary effort, this time in a form resembling an "A.B.C. of Correct Listening."

o o o o

## How to Tune.

The instructions are simple enough to be intelligible to a novice who might mistake the tuning dial for a barometer. For example, listeners who cannot hear the 261-metre transmission are advised to "try the effect of turning the tuning adjustment of the receiver, which is usually a numbered scale, DOWNWARDS." This means, it is explained, that the adjustment should be turned to a lower number.

But enough of technicalities. Even the pamphlet deserts the higher mathematics after a time with the admonition: "See your local dealer."

o o o o

## A Popular Fallacy.

One disturbing feature of the correspondence regarding Brookmans Park is the prevalent idea that mutual interference between the twin transmitters can only be temporary and that all will be well "when the stations have finished testing."

o o o o

## More Power from Brookmans Park.

On the whole, the letters are of a friendly nature, and the majority of listeners seem to be taking steps to meet the new situation. I think their difficulties are increased rather than diminished by the fact that the B.B.C. is gradually augmenting the power of the 261-metre transmitter.

o o o o

## An Opening Ceremony.

By the way, I hear that schemes are now in the air for an impressive opening ceremony at Brookmans Park when the two transmitters finish their tests. The inaugural speech will probably be made by the Postmaster-General.

o o o o

## Synthetic Echo.

Have you noticed an increase in the echo effect in the Savoy Hill studios during the past week or two? The engineers are introducing more "synthetic echo" with orchestral transmissions, and many letters of approval have already

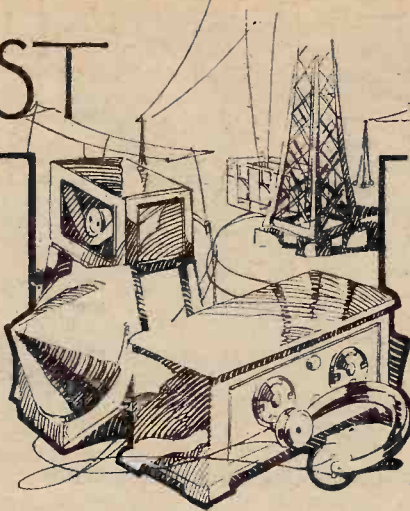

By our Special Correspondent.

been received. Hilversum and Radio Toulouse both make good use of artificial echo.

o o o o

## The Millionth Oscillator.

What a world of drama lies behind the disclosure that Savoy Hill has nearly exhausted its stack of anti-oscillation pamphlets. I hear that the original printing order was for one million copies.

Instead of ordering a reprint, the B.B.C. has decided to prepare an entirely new edition, in which the experience of a million howls will form the basis of an appeal more moving than soothing.

## FUTURE FEATURES.

- London and Daventry (5XX).**  
**FEBRUARY 2ND.**—Mozart and Haydn Concert.  
**FEBRUARY 3RD.**—Concert relayed from Frankfurt.  
**FEBRUARY 5TH.**—Symphony concert relayed from Queen's Hall.  
**FEBRUARY 7TH.**—"Warren Hastings," a play by Feuchtwanger.  
**FEBRUARY 8TH.**—Running commentary on Arsenal v. Everton football match, relayed from Highbury.  
**Daventry Experimental (5GB).**  
**FEBRUARY 3RD.**—Concert of contemporary music.  
**FEBRUARY 4TH.**—Fireside songs.  
**FEBRUARY 6TH.**—"Warren Hastings," a play by Feuchtwanger.  
**FEBRUARY 7TH.**—"Sax-Appeal," a saga of syncopation.  
**FEBRUARY 8TH.**—"Witch Wife," a drama by Michael Hogan and Mabel Constanduros; and "The Crossing," a play by Holt Marvel and Cyril Lister.  
**Cardiff.**  
**FEBRUARY 6TH.**—"Tywydd Mawr" (Heavy Weather), a programme with sea shanties, by Hilda M. Isaacs.  
**FEBRUARY 8TH.**—Operatic concert relayed from City Hall, Cardiff.  
**Manchester.**  
**FEBRUARY 2ND.**—Mendelssohn concert.  
**FEBRUARY 8TH.**—"A Matter of Policy," a play by Gordon Phillips.  
**Glasgow.**  
**FEBRUARY 6TH.**—"Scott" programme.  
**Belfast.**  
**FEBRUARY 7TH.**—Orchestral concert relayed from Ulster Hall, Belfast.  
**FEBRUARY 8TH.**—Running commentary on Rugby International football match, Ireland v. England, relayed from Dublin.

## The World Broadcast.

If, in an ordinary day, we flitted from one station to another all over the globe and heard the same transmission all the time, we should either curse the set or take a strong restorative. Last week it was different. During the broadcast of the Naval Disarmament Conference it would have been possible to hear the speeches from nearly two hundred stations. Of these nearly a hundred and fifty were in the U.S.A. and Canada.

o o o o

## A Short-wave Triumph.

The honours go to 5SW. Several stations on the Continent which had arranged to take the broadcast by land-line chose the less expensive but equally efficient method of tuning in Chelmsford. Among the stations which preferred this method were Turin, Naples, Stockholm, and Vienna, the last two starting with land-line, but resorting to 5SW because the transmission was better.

o o o o

## The Australian Beam.

There was also the "hush-hush" relay to Australia by means of the new telephony beam, which has not yet been put into public service. This was moderately successful.

Last week should certainly go down in wireless history as the occasion of the first real "world-broadcast."

o o o o

## Why Not a Carillon Recital?

It seems a pity that the B.B.C. cannot be persuaded to broadcast a recital on the New Zealand War Memorial Carillon now temporarily erected in Hyde Park. A Savoy Hill official tells me that the proposal has been rejected because the carillon has been broadcast from the North-East Coast Exhibition, but the excuse seems inadequate. Apart from the fact that carillon music broadcasts extraordinarily well, the B.B.C. might remember that the repertoire of available selections is fairly extensive, and there would be no necessity to repeat the pieces already heard.

o o o o

## New Series of National Programmes.

The first of the 1930 National programmes, to be broadcast on February 6, will consist of a tribute to France. Other countries to figure in the series later will be Belgium, Czechoslovakia, Holland, Italy, Poland and Sweden.

o o o o

## Women M.P.s at the Microphone.

"The Week in Westminster" will be described in a series of broadcasts from 2LO starting on February 5. The three M.P.s who will be responsible for describing what Parliament is doing, turn and turn about, are Miss Ellen Wilkinson, Lady Astor and Miss Megan Lloyd George.

# CORRESPONDENCE



The Editor does not hold himself responsible for the opinions of his correspondents.

Correspondence should be addressed to the Editor, "The Wireless World," Dorset House, Tudor Street, E.C.4, and must be accompanied by the writer's name and address.

## WIRELESS LICENCE SCANDAL.

Sir,—I strongly disapprove of your article on the so-called "Wireless Licence Scandal," and fail to see why the tenants of the luxury flats should not have cheap wireless, if legally entitled to it, without your communistic sob-stuff being slung at them!

In any case the tenants of these flats are probably paying several thousands of pounds in taxation compared with the cottager—who is probably on the "dole"! BM/K.V.O.  
London, W.C.1.

Sir,—Very pleased with "Editorial" in January 15th issue of *The Wireless World*. Gratifying to know that the Editor has such an eagle eye for an "injustice," and is broad-minded enough to give prominence to such a scandal in a technical journal. One of the roots of war is man's injustice to man. It is difficult to comprehend the mentality of people who will corner and violate the spirit of an Act. I suppose they would politely term it good business. Business is so often akin to charity; begins at home and covers a multitude, etc. The worst of it all is that so much good business savours of injustice, but is not brought to the light of day.

Wishing *The Wireless World* continued success.  
Chatham. H. R. G. FORSTER

## THE P.M.G. EXPLAINS.

Sir,—The Postmaster-General's attention has been called to an article which appears on page 59 of the issue of *The Wireless World* dated January 15th, entitled a "Wireless Licence Scandal," and he desires me to inform you that the statement in the daily Press to which you refer in the third paragraph is inaccurate. No change has been made in the Post Office rules relating to wireless licences for apartment houses and flats.  
G.P.O., London. W. E. WESTON,  
For the Secretary.

## REJECTOR CIRCUIT.

Sir,—Selectivity and quality of reproduction are seldom synonymous yet, and as one of the best known makers of sets can apparently do no better than provide three independent variables at the H.F. end, adjustment of any of which capsizes the lot, I send you this sketch of an arrangement which, though it contains much that is old, has the merit that it is easy to operate, needs no screening or decoupling gadgets, hairbreadth tuning, or even geared condensers, and, whilst amply sensitive, gives good reproduction with freedom from interference.

Neglecting the rejector unit for a moment, which we will suppose is disconnected by its switch above E on the left, the H.F. part consists of a straightforward arrangement of tuned anode with a tiny condenser between the aerial and the grid end of the variometer, which latter is used because, in conjunction with the variable condenser, it facilitates control of the waveform in the grid circuit, and can be adjusted so that the resonance curve will embrace the side bands. The tuned anode inductance can be damped by the variable gridleak across it, so that the H.F. valve will not oscillate, and this provides an easy control which introduces no distortion.

To tune in (rejector out of circuit), one sets the small aerial to grid condenser (Formodenser) at a small value near its minimum, and adjusts the previously calibrated tuned anode circuit, next bringing the grid circuit into resonance. The Formodenser should be set so that signals are about half as loud as could be obtained if it were not in circuit. Then the rejector switch is closed and the rejector brought into resonance, which can be done without upsetting the grid tuning at all, when the signals will greatly increase in strength.

We now have a loose coupled aerial system in which the coupling unit is the small condenser, with all the advantages of loose coupling, none of the drawbacks of inductive coupling, the beneficial double hump resonance curve to include the side bands, combined with unusual freedom from interference. But it is useless to expect such results unless the rejector is made up on proper rejector lines, with exceedingly low resistance, unless reaction is to be used, when we come to the Hinton rejector principle.

The theory of the rejector is well expounded in the Admiralty Handbook for Wireless Telegraphy (pp. 152-157), 1925 edition, and may be summarised by saying that the non-resonant frequencies are more readily drained away from the aerial as C becomes larger while L decreases, but that the voltage across the rejector falls somewhat as L decreases, all provided that the resistance is exceedingly low. The rejector inductance

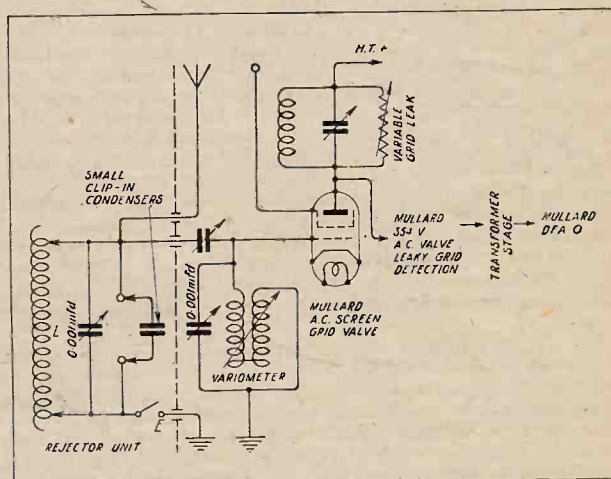

should be made of something like copper strip, and the condenser should have definitely low resistance connections, particularly to the rotor, and the leads to the inductance should be of heavy flex.

As a guide to the ratio of L and C, for the region 2LO to Budapest, C can be increased to one-sixth of LC without undue clipping of the side bands, because of the double hump due to the coupling, but this takes us beyond any selectivity usually needed. It will be noted that the aerial capacity acts in parallel with the rejector condenser, and further, that, since the path to earth is so easy for non-resonant frequencies, neither they nor must get into the grid coil. I can, however, give no guarantee that in this part of the country our enthusiastic friend FFB (Boulogne) will not force the set once in a way. Such a rejector can be readily applied to any set as a separate unit provided that no inductive coupling is made with the set components.

Ashford, Kent.

WM. A. RICHARDSON.



## IN SEARCH OF QUALITY.

Sir,—Let us congratulate Mr. Bertram Munn for his courageous article "In Search of Quality," even though we may not agree with his hearty condemnation of our particular pet—the moving coil. Nothing will convince me that the reproduction with his present unit is superior to a *really* good moving coil with an appropriate amplifier behind it, but undoubtedly his castigations of the average M.C. are well merited. There is, Mr. Munn, such a thing as a moving-coil speaker that does not thud.

But this letter is meant to be helpful and is prompted by Mr. Munn's penultimate paragraph, wherein he realises that his unit is not beyond reproach. Actually I am wondering if he has heard of the Western Electric 555W receiver. Moving-coil cone enthusiast that I am, I must admit that this unit on a large logarithmic horn beats the cone type easily. Added to which it is more efficient. But there are sundry snags: (1) I do not know if they are easily obtained, (2) they are probably expensive, judging by the workmanship, (3) the field eats up 1½ amps. at 7 volts, and (4) an output transformer would be required, the impedance being 15 ohms. And I hope that Mr. Munn will pardon me if I suggest that his horn would hardly do it full justice—the firm use a 14ft. horn cutting off at 57 cycles.

On reading this over I am afraid that it does not sound so helpful as it was intended to be, but I am sure that Mr. Munn would find that the results obtained would more than counter-balance the snags mentioned.

Incidentally, there was an article in *The Wireless World* about two months ago describing the fitting of such a unit on a horn some 25ft. long!  
R. C. PLAYER.  
Worcestershire.

## B.B.C. TRANSMISSIONS.

Sir,—The trouble with the "Look to your set" type of apologists for the shortcomings of the B.B.C. transmissions is that they seem to be as deaf to argument as they appear to be deaf to the imperfections of wireless. They ignore the fact which so many of us experience, namely, that, given a constant instrument at the receiving end, the quality of the sounds emitted by that instrument varies very considerably even when they are caused by the same transmitter on the same evening.

Speaking for myself, let me say that I am very conscious of the imperfections of my receiver, though it happens to include a liberal H.F. input to a diode rectifier, a resistance-coupled L.F. amplifier, L.S.5A output valve with 350 volts on its plate, a M.C. loud speaker and most, if not all, other modern improvements; and though some of my indiscriminating friends are kind enough to say that it gives results just like "the real thing."

The receiver, like all others, is undoubtedly imperfect. But that is really wide of the mark.

The point is that no receiver can, to take a striking example, accentuate the sibilants at one moment and almost entirely omit them the next, if that receiver remains unaltered. The fault must lie somewhere in the transmitting end; and, whilst the B.B.C. devote such a great deal of space in their publications to criticisms of their programmes, they give so very little space to criticisms of their transmissions from the technical point of view.

No doubt, as has been pointed out, faults at the transmitting end are often directly due to what one may call faulty wireless technique on the part of the various artists, or to errors of judgment in the control room. Artists who, so to speak, hurl their stuff at the microphone "come through" badly, whilst others who know how to humour the instrument come through far better. And the gentleman in the control room sometimes pushes something which, I take it, corresponds to a joy-stick forwards when he ought to push it back, and vice versa. But what does all this really show?

Surely no more than that the wireless transmitter, even at its best, is an imperfect instrument. And that is just the point which those of us who do not think that finality has been reached at the transmitting end are trying to make.

That all is not really perfect at the transmitting end is surely clear from the following quotation from the B.B.C. Year Book,

p. 65 (the italics are mine):—"The *microphone* and the loud speaker continue to be the weakest links in all the long chain between artist and listener. The B.B.C., however, can record an advance in microphone design. A high quality capacity microphone has passed several severe tests and looks like being a standard for *most* studio work. The simpler and *more robust* carbon microphone must still carry the load of outside broadcasts, *cruder transmissions*, and so on, for some time to come."

From which it seems fair to conclude that even the most up-to-date microphone has its failings and that the "cruder" carbon microphone is responsible for at least some of the distortion which those of us who have ears to hear with so often notice.

But why, one wonders, is information of this kind tucked away in a publication which appears but once a year, and why is it so very meagre as regards details? The B.B.C. transmissions are, in general, so good that surely the B.B.C. themselves can well afford to publish more information about them and more fair criticism of them? If this were the case, then we at our end would be in a far better position to "look to our sets" and correct as far as we can such failings as are there.  
E. C. RICHARDSON.

Sir,—I must reply to Mr. A. Gregson, of Bolton. I have heard fifty-nine stations on my set (not all at once), and, without any doubt whatever, Manchester has the other fifty-eight beaten to a standstill when it comes to quality.

Blackpool.

"POLAR."

## GRAMOPHONE SPEED TESTER.

Sir,—Your gramophone speed tester is a most useful accessory.

The supply here is 200 v. 100 cycles, and, as there are many here who will no doubt like the advantages without having to draw up a fresh disc, perhaps you would publish the enclosed diagram, which enables it to be used without any further trouble.

No damage is done to the battery, which can be connected either way round.

Impulses are passed one way only, giving a 50-cycle effect.  
Bournemouth.  
J. P. J. CHAPMAN.

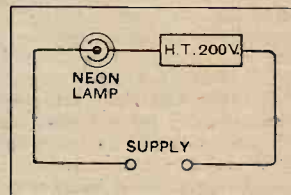

## RECEPTION OF CONTINENTAL STATIONS.

Sir,—With regard to the "Regional Scheme," "Reception of Continental Stations," and "The Thirst for Power," I should like to contribute some observations. Each country has its regional scheme. Warsaw, our capital, now has a station working with 12 kW. which in the near future will be 120 kW. In a week or so we are to have 1½ kW. local stations working on 218 metres. Everything is done for the crystal set user and to cater more and more for such listeners. But in your country, where crystal users are in a minority, there is no reason to erect so many powerful stations as 5XX, 5GB, and the new 2LO. I, personally, am very pleased that the power of 2LO is so strong that I can receive it at 11 p.m. on a one-valve Reinartz set in Warsaw, but it is a pity that it very often interferes with Graz, and then it is no pleasure to listen to Brookmans Park. I would like to appeal to all *Wireless World* readers to consider which foreign stations are worth listening to and make a record of them. After obtaining such material all European radio editors might collect it and send it to the next international radio conference with the listeners' requests that the selected stations might get more consideration in the ether. In this way it should be possible to increase the power of selected stations and minimise interference. According to the "Regional Scheme" I believe it is far better to erect many ½ kW. stations on the same wavelength than a few powerful stations. Listening sometimes on Berlin's common wavelength I can say from experience that distant reception is quite possible with very slight marring. In the selection of stations I would suggest as a standard the use of 1SG-V-2 sets.

M. S. MARCINKOWSKI.

**READERS' PROBLEMS**

**ANSWERED**

The Service is subject to the rules of the Department, which are printed below; these must be strictly enforced in the interest of readers themselves.

A selection of queries of general interest is dealt with below, in some cases at greater length than would be possible in a letter.

"The Wireless World" Supplies a Free Service of Technical Information.

**Lost Volts.**

The screening grid of my 1-v-1 receiver is fed through a 1,000-ohm decoupling resistance. In determining the correct point on the H.T. battery to which the lead feeding this circuit should be connected, is it necessary to take into account the voltage absorbed in the resistance?

A. C. P.

Practically speaking, no. Assuming a screening grid current of 0.5-milliamp., 0.5 volt only will be "dropped" in the resistance.

o o o o

**Gramophone Speed Indicator.**

Can you supply data for making an indicator on the lines described in your issue of January 8th, but modified to suit a 40-cycle supply? M. F. P.

The number of black lines required on the stroboscopic disc is arrived at by multiplying the A.C. frequency by 120 and dividing by the required r.p.m. of the gramophone turntable. This calculation will reveal that 60 bars will be needed on the disc when running at 80 r.p.m. and used with a 40-cycle supply. For 78 and 79 r.p.m. the relationship between frequency of supply and revolutions per minute is not an exact quantity.

**RULES.**

- (1.) Only one question (which must deal with a single specific point) can be answered. Letters must be concisely worded and headed "Information Department."
- (2.) Queries must be written on one side of the paper, and diagrams drawn on a separate sheet. A self-addressed stamped envelope must be enclosed for postal reply.
- (3.) Designs or circuit diagrams for complete receivers cannot be given; under present-day conditions justice cannot be done to questions of this kind in the course of a letter.
- (4.) Practical wiring plans cannot be supplied or considered.
- (5.) Designs for components such as L.F. chokes, power transformers, etc., cannot be supplied.
- (6.) Queries arising from the construction or operation of receivers must be confined to constructional sets described in "The Wireless World" or to standard manufacturers' receivers.

Readers desiring information on matters beyond the scope of the Information Department are invited to submit suggestions regarding subjects to be treated in future articles or paragraphs.

A37

**The Output Filter as an Aid to Stability.**

Is it correct to assume that an output filter will tend to prevent L.F. oscillation and motor-boating in a receiver fed from an eliminator or from a battery with a high internal resistance?

E. M. N.

Yes. As compared with the more usual practice of connecting the loud speaker direct in the anode circuit of the output valve, the use of a filter confers an important advantage, because its inclusion tends to deflect the audio-frequency component from any resistance or impedance in the common anode circuit.

o o o o

**Another Harassed Parent.**

Inspired by your reply to "T. S. W." in the "Readers' Problems" section of your issue for December 25th, I have been trying to connect a microphone in the detector grid circuit of my "Everyman Four" receiver (revised circuit, as described in the fourth edition of the booklet). Unfortunately, this addition results in instability over a good deal of the tuning scale unless the H.F. valve filament is dimmed considerably; for local station reception this is not a serious drawback, but it is rather inconvenient to have to disconnect the microphone transformer when distant stations are to be received.

Can you give me any hints as to how the trouble may be overcome, and at the same time suggest a method of using the L.T. battery of the set for supplying current to the microphone circuit—if this is possible, as I believe it is?

W. B. B.

It is not unusual to find that the addition of any extra wiring in the detector grid circuit will bring about instability unless all the leads are kept very short, and in the first place we would suggest that you should try to improve matters in this respect.

Perhaps it would be as well to adopt the arrangement shown in Fig. 1; this includes an arrangement of non-inductive resistances and a by-pass condenser which will tend to prevent the development of H.F. potentials at points where they may be passed back by stray inductive or capacitative coup-

lings to the grid circuit. If possible, we recommend you to earth the core and metal shroud (if any) of the microphone transformer. The by-pass condenser, given as 0.002 mfd., should be as large as it is possible to make it without bringing about too serious a reduction of microphone signal strength.

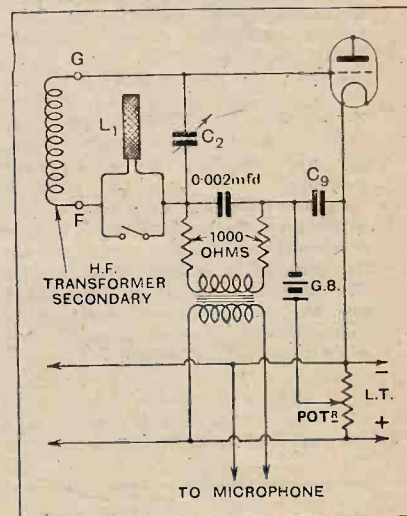

How to introduce a microphone into the detector circuit of the "Everyman Four."

The low-tension battery may be used in the manner indicated for supplying the microphone circuit; it should be pointed out that, if necessary, a series resistance may be inserted in order to reduce the flow of current.

o o o o

**Station-to-Station Switching.**

Will you please tell me if it would be possible to adapt the method of tuning (with fixed coils and semi-variable condensers) included in the "Twin-Station Two" for reception of the two Daventry stations? W. T. R.

This method is not applicable to the design of a set intended to receive two transmissions of widely divergent wavelength. To attain this object with a switch change-over it is, practically speaking, necessary to duplicate both the coils and condensers.

**Switched Neutralised H.F. Amplifiers.**

From statements made from time to time in "The Wireless World," I gather that it is by no means easy to apply the principle of waveband switching to a neutralised H.F. amplifier. Will you please tell me if a practical design of a receiver including this arrangement has been published? C. D. N.

As you suggest, it is rather difficult to introduce a switching scheme into an amplifier of this sort, partly because it is necessary to make provision for changing over at least three circuits—primary, secondary and neutralising. Troubles are most likely to be encountered when one is aiming at high efficiency on both medium and long wavebands. The problem could be simplified a good deal if one were content with comparatively low amplification on, say, the long waveband.

A receiver with neutralised H.F. amplification (three-electrode valve) was described in our issues of July 4th and July 11th, 1928.

**"A Quality Receiver."**

I live almost exactly midway between the London and Daventry stations; taking into account the comparatively high power of these transmissions, do you consider that the receiver shown in Circuit No. 3 of "The Wireless World Diary" for 1930 would be sufficiently sensitive for the reception of these transmissions?

If it is considered that more amplification is necessary, I take it that a neutralised triode would provide all that is necessary, and should like to have a circuit diagram showing the modifications necessary to this receiver, plus an added separately tuned aerial circuit.

T. D. B.

In our opinion it would be unwise to expect this comparatively insensitive receiver as it stands to provide suffi-

**FOREIGN BROADCAST GUIDE.**

**MOSCOW-POPOFF**

(Russia).

Approximate Geographical Position: 55° 42' N. 37° 39' E.

Approximate air line from London: 1,552 miles.

Wavelength 1,103 m. Frequency 272 kc. Power 40 kW.

Time: Eastern European (two hours in advance of G.M.T.).

**Standard Daily Transmissions.**

14.30-15.00 G.M.T. musical concert (Wednesdays: 16.00-18.30). 18.00 or 18.30 relays of other Russian stations, or foreign programmes. Tuesdays: gives own studio programme, and dance music at 21.00

Man and woman announcers. Call (phonic): Sloo-schah-ee-tee (twice), sdie Govoreet Moskva Popov. Between items: Govoreet Moskva Radio Central.

Closes down with words: Das-vee-dan-yeek spak-on-yeek-notch (au revoir, good night).

ciently strong signals from the stations whose programmes are required, and we feel sure it would be best and safest to add an H.F. stage—which, as you suggest, may be of the low-gain variety. It is assumed that the long-wave Daventry transmission will not be required, so the design may be simplified accordingly.

The circuit diagram for which you ask is given in Fig. 2; for the sake of completeness, we have added the L.F. amplifying portion of it, and have included capacity-controlled aerial coupling, as this arrangement is both simple and adequate.

**Absorbing Surplus Voltage.**

Is there any limit to the voltage that can be safely absorbed by a resistance inserted in series with the anode of an amplifying valve? In my own particular case I wish to reduce a voltage of 450 to 150 volts—the maximum specified by the makers of the valve.

E. T. H.

In this case it should be quite in order to insert a series resistance (of a value depending, of course, on the current consumed by the valve). It is safe enough to do this when dealing with an amplifying valve, but it would hardly be wise in the case of an anode bend detector, of which the mean anode current varies with impressed signal voltages.

**Accumulator Charging at Home.**

I estimate that a 600-watt lamp would be required to pass the necessary current for charging my L.T. accumulator from the D.C. mains supply. It is understood that lamps of approximately this wattage can be obtained, but they are very expensive, and I am inclined to think that in this case some other form of resistance would be much better. Will you please give me your advice?

E. R.

Although lamps will serve as voltage-reducing resistances, it is hardly recommended that they should be used when a heavy current is to be passed, but it may be pointed out that in your case there is no need to use a single expensive lamp of the full required wattage. It would be more economical to employ a number of cheap carbon filament lamps connected in parallel.

Perhaps your best plan is to use a "bowl heater" or similar appliance. These are not very costly, and in many cases the heat given off may be used to advantage, thus offsetting the usually heavy cost of charging low-tension accumulators from a D.C. supply

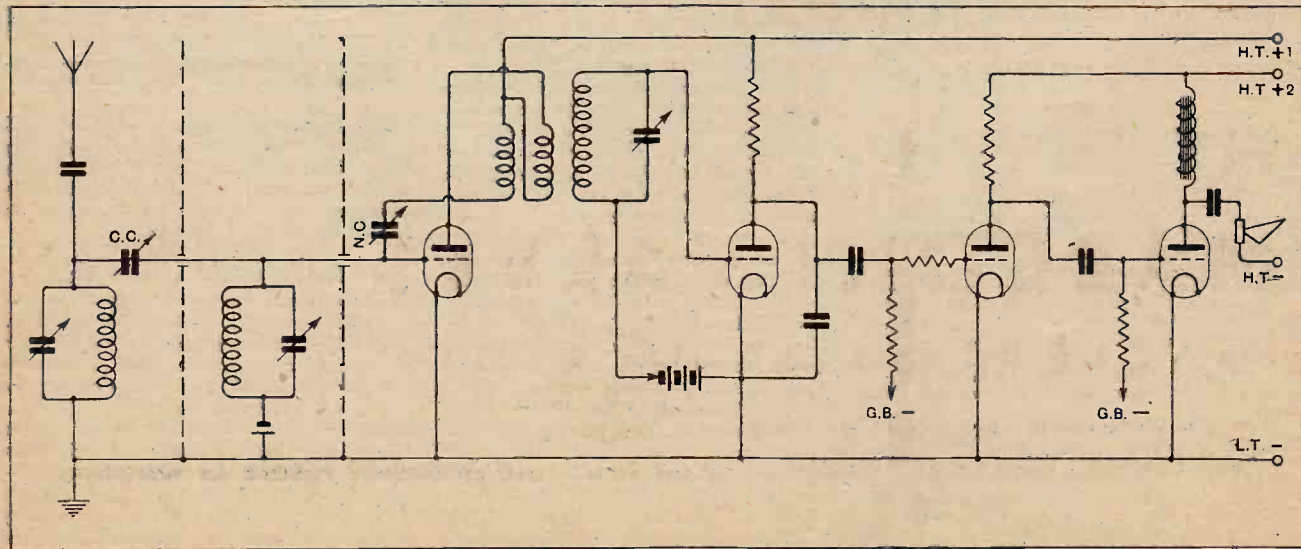
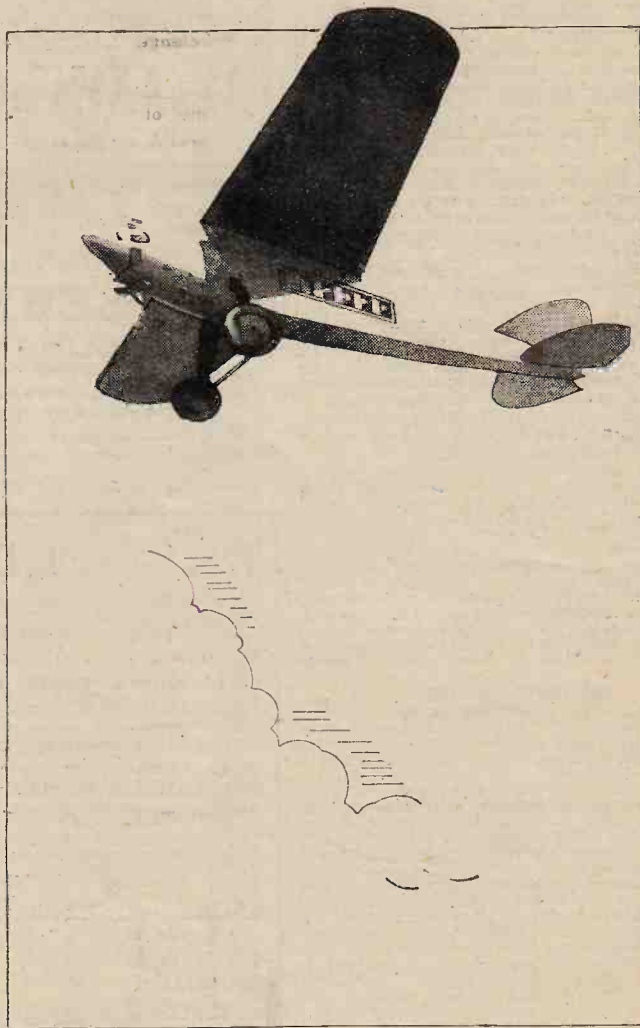

Fig. 2.—A "Wireless World Diary" circuit with two low-gain L.F. stages, modified by the addition of an H.F. amplifying valve.

# 3 HOURS — 300 MILES !

10,000 FEET UP! Giant Air Liner roars through clouds. Airport wirelasses warning—"Fog over French Coast." 'Plane in constant touch — receiving orders, reporting weather conditions—*through Marconi Valves.* All Imperial Airways machines are fitted with Marconi Valves. So is Croydon Control Tower. All British Broadcasting Stations . . . all Trinity House lightships . . . all Trinity House beacon stations . . . most British passenger ships . . . use Marconi Valves. For their reliability. For their long life. For their wide range.

● *In cases like these, when unfailing efficiency is essential, men insist on Marconi Valves*



## FIT

# MARCONI VALVES

## TO YOUR RADIO SET

Give you clearer tone, greater volume, longer range. Cost not a penny more. Fit any set.



***The first and greatest name in wireless***

MARCONIPHONE COMPANY LIMITED, 210-212 Tottenham Court Road, London, W.1

A39 Advertisements for "The Wireless World" are only accepted from firms we believe to be thoroughly reliable.

# MISCELLANEOUS ADVERTISEMENTS.

## NOTICES.

**THE CHARGE FOR ADVERTISEMENTS** in these columns is:

12 words or less, 2/- and 2d. for every additional word.

Each paragraph is charged separately and name and address must be counted.

**SERIES DISCOUNTS** are allowed to Trade Advertisers as follows on orders for consecutive insertions, provided a contract is placed in advance, and in the absence of fresh instructions the entire "copy" is repeated from the previous issue: 13 consecutive insertions 5%; 26 consecutive, 10%; 52 consecutive, 15%.

**ADVERTISEMENTS** for these columns are accepted up to **FIRST POST ON THURSDAY MORNING** (previous to date of issue) at the Head Offices of "The Wireless World," Dorset House, Tudor Street, London, E.C.4, or on **WEDNESDAY MORNING** at the Branch Offices: 19, Hertford Street, Coventry; Guildhall Buildings, Navigation Street, Birmingham; 260, Deansgate, Manchester; 101, St. Vincent Street, Glasgow, C.2.

Advertisements that arrive too late for a particular issue will automatically be inserted in the following issue unless accompanied by instructions to the contrary. All advertisements in this section must be strictly prepaid.

The proprietors retain the right to refuse or withdraw advertisements at their discretion.

Postal Orders and Cheques sent in payment for advertisements should be made payable to **ILLIFFE & SONS LTD.**, and crossed **& Co.** Notes being untraceable if lost in transit should not be sent as remittances.

All letters relating to advertisements should quote the number which is printed at the end of each advertisement, and the date of the issue in which it appeared.

The proprietors are not responsible for clerical or printers' errors, although every care is taken to avoid mistakes.

### NUMBERED ADDRESSES.

For the convenience of private advertisers, letters may be addressed to numbers at "The Wireless World" Office. When this is desired, the sum of 6d. to defray the cost of registration and to cover postage on replies must be added to the advertisement charge, which must include the words Box 000, c/o "The Wireless World." Only the number will appear in the advertisement. All replies should be addressed No. 000, c/o "The Wireless World," Dorset House, Tudor Street, London, E.C.4. *Readers who reply to Box No. advertisements are warned against sending remittance through the post except in registered envelopes; in all such cases the use of the Deposit System is recommended, and the envelope should be clearly marked "Deposit Department."*

### DEPOSIT SYSTEM.

Readers who hesitate to send money to unknown persons may deal in perfect safety by availing themselves of our Deposit System. If the money be deposited with "The Wireless World," both parties are advised of its receipt.

The time allowed for decision is three days, counting from receipt of goods, after which period, if buyer decides not to retain goods, they must be returned to sender. If a sale is effected, buyer instructs us to remit amount to seller, but if not, seller instructs us to return amount to depositor. Carriage is paid by the buyer, but in the event of no sale, and subject to there being no different arrangement between buyer and seller, each pays carriage one way. The seller takes the risk of loss or damage in transit, for which we take no responsibility. For all transactions up to £10, a deposit fee of 7/- is charged; for transactions over £10 and under £50, the fee is 2/6; over £50, 5/-. All deposit matters are dealt with at Dorset House, Tudor Street, London, E.C.4, and cheques and money orders should be made payable to Illiffe & Sons Limited.

### THE SALE OF HOME-CONSTRUCTED UNLICENSED APPARATUS.

#### A Service to our Readers.

We have made an arrangement with the Patentees whereby readers who wish to dispose of a home-constructed receiver not licensed under the patents made use of, can license the set by means of the Deposit System referred to above.

The person desiring to sell, in sending us particulars for his advertisement, will in every case make use of a Box No., and should add to the price which he requires the amount of royalty customarily paid by manufacturers.

If the purchaser is satisfied with his purchase, the sum realised will be forwarded to the seller, less the amount due in respect of royalties, which amount will be paid by "The Wireless World" to the owners of the patents concerned, and a certificate will be handed on to the purchaser of the set.

**SPECIAL NOTE.**—Readers who reply to advertisements and receive no answer to their enquiries are requested to regard the silence as an indication that the goods advertised have already been disposed of. Advertisers often receive so many enquiries that it is quite impossible to reply to each one by post.

## ALL WIRELESS WORLD COILS

1930 EVERYMAN FOUR	47/6 set
KIT SET, Coils with Switches	45/- set
NEW KILOMAG.	45/- set
RECORD III	45/- set
FOREIGN LISTENERS 4 B.B.C.	30/- set
	5XX 37/6 set
METAL CABINETS	38/6 to 48/6
5 1/2" DRUM DIALS with Escutochons	5/6
WAVE TRAP, Litz Wire	10/6 each

## B & J. Wireless Co.

2, 3, & 4, Athelstans Mews,  
Stroud Green Road, N.4.

Archway 1695

"END OF YEAR CLEARING."

## APPLEBY'S

FOR BARGAINS WATCH Phone: Paddington 8828 (3 lines)

THE MISCELLANEOUS COLUMNS THIS MONTH.

For Modern High-grade Material Only.

**CHAPEL ST., LONDON, N.W.1**  
OPEN TILL 7 P.M. SAT. 1 P.M.

## THE GREAT DEMAND

for C.D.M. components has compelled larger premises to be taken. When sending for goods, please note new address, to save delay.

**C.D.M. H.F. CHOKES**, suitable on 15 to 2,000 metres, 5/- and 4/- each.  
**MOTORBOATING STOPPER** - 7/- each.

**FIXED MICA CONDENSERS.**

·0005 to ·002	1/3 each.
·0025 to ·006	1/9 "
·01	2/9 "

**C.D.M. DUONATOR.**

·0003 and 2 meg. combined	2/- each.
---------------------------	-----------

**WAVE TRAP** - - - 7/6 each.  
**REJECTOR** - - - 8/6 "

**RESISTORS**, all prices upon application.

## C. D. MELHUISH

NEW ADDRESS:

**MAXWELL WORKS,**  
Conewood St., Highbury, London, N.5

RENOWNED for SILENCE

DEPOSIT SECURES.

## 10/-

## PHILIPSON'S "SAFETY"

H. T. SUPPLY UNITS. AND RELIABILITY

£1.17.6 to £6.0.0

**PHILIPSON & Co., Ltd.,**  
Radio Engineers,  
BOLTON 2038. **ASTLEY BRIDGE, BOLTON.**

## RECEIVERS FOR SALE.

**SCOTT SESSIONS and Co.**, Great Britain's Radio Doctors—Read advertisement under Miscellaneous. [0264]

**FERRANTI** 5-valve, push-pull amplifier, twin turntables, Magnavox speaker on 3ft. baffle, all new; cost £56, accept £30; delivered within 100 miles.—Bradford, Entertainer, Whitechurch, Bristol. [7943]

**B.T.H. Senior R.K. Amplifier**, mahogany case, cost £45, accept £20; also Burnsted Screened Four, as new, £12.—Box 4605, c/o *The Wireless World*. [8056]

**METRO** Vick 5-valve Set, switch 4 valves, new 2 volt valves, 3 super power, also 5-6-volt valves included, 2 coil boxes, long and medium waves, good condition; cost £35, accept best offer over £8.—Smart, 30, Treen Av., Barnes, S.W.13. Tel.: Putney 4050. [8053]

**5 VALVE** Solodyne, complete, 2 spare valves, 180v. H.T., 6v. L.T. accumulators, Western Electric moving coil speaker; sacrifice, £25.—Lloyd, 9, Primrose Mansions, S.W.11. [8052]

**METRO** Vick 3-valve Set (V.2R.C.), complete, with accumulator, 2 60-volt H.T. batteries, Amplion horn unit, type A.R.39; £3, post extra.—Watts, 1, Milton Rd., (Entrance Elm Dale), Tyndall's Park, Bristol. [8049]

**EXPENSIVE** Ex Government Testing Set, in mahogany cabinet, with box of shunts, measures, voltage resistance, and current; cost £25, offered for £6/5; approval, deposit.—Owen, Wireless Works, Hodnet, Salop. [8046]

**BARGAIN.**—Ready Radio portable screened grid 4-valve set, in beautiful mahogany cabinet, as new, £22/1, accept £10/10; also Blue Spot 66K, assembled with Squire cradle in mahogany cabinet, not used, £2/2/6.—E. A. Barker, 91, Hounsditch, E.C.3. [8044]

**3-VALVE** Short Wave and Broadcast Receiver, complete, walnut cabinet, balanced armature speaker, 'phones, Jack switching, new valves, batteries, etc.; £10.—Below.

**BOWYER LOWE** 7-valve Superhet, folding frame, 2 sets of valves; what offers?—Bloom, Fire Station, Letchworth. [8037]

**GECOPHONE** 2-valve Cabinet, H.F. and D. D.E. valves, coils, Gecophone amplifier, 2-stage L.F. D.E.R. valves, plug adaptors, 3 pairs 'phones, phone disc board; 5 guineas lot.—Pringle, 420, Main Rd., Darnall. [8035]

**ALL Mains** Gambrell A.C., 4-valve; £15 (cost £42)—S.M.D., 2, Bucknall St., W.C.2. [8032]

**MULLARD** 3-valve Screened Grid, set in fine mahogany cabinet, enclosing H.T. batteries and L.T. accumulators, almost new; 10 guineas, or near offer.—Box 4553, c/o *The Wireless World*. [8024]

**WIRELESS** Portable Sets, with 5 Cosmor new process valves, for 9 guineas; less than components cost, comparable with any set double this price, Royalty paid; seen between 1 and 2 p.m., or particulars sent on receipt of stamped addressed envelope.—G. Hodgson, 53, Windsor House, Victoria St., Westminster. [7971]

**GRAMOPHONE** Amplifiers and McMichael Portable Sets Lent on Hire; sets modernised, installed and maintained.—Alexander Black, The Wireless Doctor, 55, Ebury St., S.W.1. Eloane 1655. [0328]

**NATIONAL** Portable, just overhauled by makers, new batteries, perfect tone; £8.—BM/BRIER, London, W.C.1. [8041]

**We Offer You the Following Inducements to Purchase Your New Receiver or Other Apparatus from us.**

**FIRSTLY.**—Unbiased advice. The Principal of the firm has twenty years' professional wireless experience, having been at Government Experimental Stations in 1910. He has been Manager for the Sterling Telephone Co., radio expert to the G.E.C., and Chairman of the Technical Committee of the National Association of Radio Manufacturers. His advice has saved our clients many thousands of pounds, for, as everybody knows, there is no hobby on which more money is wasted on useless apparatus by the uninitiated.

**SECONDLY.**—We take your old apparatus in part exchange for new. Send us a list of your old apparatus, or, better still, send us the apparatus, and state your new requirement. We will then make our offer for your goods, and if you do not approve, which is unlikely, we will return the parcel, carriage paid.

**If You are in Doubt as to the Make of Receiver or other Apparatus you should Purchase, write to us, and we will advise you; we have no leaning towards any particular maker, and will tell you the particular instrument you should buy for your purpose.**

**SCIENTIFICO DEVELOPMENT CO.**, 51, Fiehergate, Preston. Tel.: 1364. [0226]

**SIMMONDS BROS.**—Receivers constructed to your own or any published design; also repairs, re-constructions; and modernisations at moderate charges; best materials and workmanship guaranteed; numerous testimonials; quotations free.—Address, Shireland Rd., Smethwick. [5882]

**THREE** 2-valve Sets, £3 each; four 3-valve sets, £4 each; three 5-valve portables, £8 each; new and ready to switch on; guaranteed; many other bargains while they last.—Adams, 48, Tyrwhitt Rd., S.E.4. [8075]

Mention of "The Wireless World," when writing to advertisers, will ensure prompt attention.

Receivers for Sale.—Contd.

**6-VALVE** Fada Special; £5.—Goodmans, 27, Farringdon St., E.C.4. [8099]

**3-VALVE** A.C. Mains, both wavelengths, suitably selective for close to Brookmans Park, mahogany case; selling account getting larger set.—Box 4615, c/o *The Wireless World*. [8112]

**FLAT-DWELLERS'** Three, all mains, complete set parts as specified, including box, valves, etc.; cost £20. £12, no offers.—Box 4614, c/o *The Wireless World*. [8104]

**3-VALVE** Set, with Osram P.240, Exide H.T. 120 volts, and Trickle charger (220v.), Ediswan speaker, set in mahogany dome top cabinet with doors, G.B. and Exide L.T.; £10; vendor building mains set.—Bryant, 2, South Ridgway Place, Wimbledon, S.W.19. [8092]

**ZENITH** American 6-valve Nentrodyne, with valves, perfect, single control, 35 stations; £8—2s, Salisbury Rd., Seven Kings, Essex. [8088]

**3-VALVE** Portable, £4/15; suitcase 5-valve, £6; both complete, perfect, guaranteed.—Harris, 8, Rusham Rd., London, S.W.12. [8083]

**SUPERHETERODYNE**—Igranic Superhet., 6 valves, with additional H.F. unit, 7 valves in all, complete with all valves, frame aerial, etc., perfect condition, fully licensed; genuine bargain, £10, or near offer considered.—Burbidge, "Timeiscombe," Solihull. [8072]

**MICHAEL** S.V. suitcase Portable, as new, new batteries; 18 guineas, cost 28 guineas.—Box 4613, c/o *The Wireless World*. [8069]

**PHILIPS** 3-valve Set, A.C. eliminator, 200-250 volts, Philips cone speaker equal new, very cheap, what offers? Also Magnavox moving coil horn speaker, with A.C. rectifier.—C. R., 21, Highbury Quadrant, N.5. North 1508. [8063]

**PHILIPS** All Electric 3-valve Set, also Celestion C12, just new; for quick sale £20, or nearest offer.—McEwen, 17, Craven Rd., W.2. [8062]

**HALCYON** 5-valve Portable, 30 guineas, just overhauled by Halcyon; Celestion speaker, perfect, £14/10.—4, Brecon Rd., Handsworth, Birmingham. [8090]

ACCUMULATOR HIRE.

**DON'T** Buy Accumulators or Dry Batteries, join our C.A.V. low and high-tension accumulator hire service, the largest and best in London; better and cheaper reception with no trouble; regular deliveries within 12 miles of Charing Cross; no deposit, payment on each delivery or by quarterly subscription; over 10,000 satisfied users; explanatory folder post free; phone or write to-day.—Radio Service (London), Ltd., 105, Torrington Av., N.W.5. Phone: North 0623-4-5. [7596]

**C.D.E.S.** Accumulator Hire and Maintenance Service (5 mile radius)—98, Cherry Orchard Rd., Croydon. [6374]

BATTERIES.

**WET** H.T. Replacements.—Sacs (capped or uncapped), highest grade, No. 1, 10d. per doz.; No. 2, 1/9 per doz.—See below.

**ZINCS**—Best quality (wired), No. 1, 8d. per doz.; No. 2, 9d. per doz.; orders valued 5/- carriage paid, otherwise 6d. for postage.—British Battery Co., Charendon Rd., Watford, Herts. [0258]

**FULLER** H.T. Accumulators for Sale, owner changing to mains; 120 volt 2 a.h., just overhauled by makers, each cell air spaced and mounted in rubber treated wood crates, 2/-, tappings charged; inspection Bristol.—Offers to Box 4602, c/o *The Wireless World*. [8058]

CHARGERS AND ELIMINATORS.

**TANTALUM** and Liumion for A.C. Rectifiers; make up your own inexpensive chargers; blue prints for H.T. and L.T. 1/- each; Liumion electrodes fitted with terminals, 2-3 amps. and 5-8 amps.—Blackwell's Metallurgical Works, Ltd., Speke Rd. Works, Garston, Liverpool. Phone: Garston 980 (2 lines). [6282]

**PHILIPSON'S** Safety High Tension Battery Eliminators.

**10/-** Down and the Balance in Easy Monthly payments secures the finest high tension supply available.

**PHILIPSON'S** Safety Eliminators are Guaranteed for 12 Months.

**PHILIPSON'S** Safety Eliminators are the Cheapest to Install and the Cheapest to Run; prices: Model A.C.5 £4/17/6, A.C.7 £3/17/6, complete with full wave, rectifiers; D.C.4 37/6, D.C.5 45/-.

**ALL** Models Obtained for 10/- Deposit; take advantage of this and get constant high tension immediately.

**WRITE** for Our Booklet, "Radio Power" to Philipson and Co., Ltd., Radio Engineers, Astley Bridge, Bolton. Phone: 2038. Grams: Safety, Bolton. Est. over 50 years. [0318]

**CHEBROS**—Chebros for all types of transformers and chokes, high grade instruments at a very moderate price; enquiries invited.—Chester Bros., 244, Dalston Lane, London, E.8. [5290]

Light on a new J.B. model

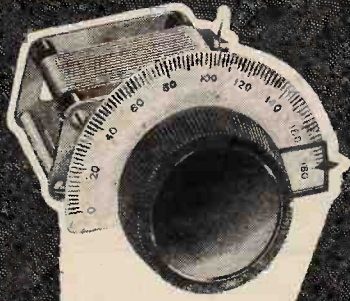

"Sensational" describes this new J.B. Condenser, since it takes up little more room than a match box while retaining all the features of the largest and finest instruments. Highly efficient and reliable under all conditions.

J.B. "TINY" CONDENSER

Prices:  
-0005 -0003  
10/- 9/6  
-0002 -0001  
9/- 8/6

Fitted with Slow Motion Control, Ball Bearings, Pit-tail Connection and Hard Aluminium Vanes. Supplied complete with knob, pointer and scale.



Advt. of JACKSON BROS., 72 ST. THOMAS' STREET, LONDON, S.E.1. Telephone: Hop 1887.

Chargers and Eliminators.—Contd.

**TRANSFORMERS** and Chokes for Battery Eliminators and for all wireless purposes, receiving or transmitting; enquiries invited.—Chester Bros., 244, Dalston Lane, London, E.8. [7587]

**SECOND-HAND** Philips's Rectifier for Sale, 190-200 volts, 40-100 cycles, complete, perfect condition; £2.—May be seen at 24, Comaught Av., East Sussex, S.W.14. [8039]

**VALLEY** A.C. Charger, H.T. and L.T.; £2/10.—Scott, 10, East Parade, Ilkley [8051]

**SAVAGE'S** Specialise in Wireless Power from the Mains, reliable apparatus at reasonable prices.

**SAVAGE'S**—Transformer laminations and bakelite bobbins; intending home constructors should write for list.

**SAVAGE'S**—Reliable smoothing condensers, 1,000 volt D.C. test, 1 mfd., 2/-; 2 mfd., 3/-; 4 mfd., 5/3; 500 volt D.C. test, 1 mfd., 1/6; 2 mfd., 2/3; 4 mfd., 3/9.

**SAVAGE'S**—Super smoothing and output chokes, many types available; write for list.

**SAVAGE'S**—Mains transformers for Westinghouse H.T.4 unit, 18/6; A.3, 17/-; A.4, 20/-.

**SAVAGE'S**—Mains transformers for Westinghouse H.T.4, with additional winding, 4 volts 3 amps. 23s.

**SAVAGE'S**—Mains transformers V.T.31, 200-200 volts 60 m/amps, 2+2 volts 2 amps, 2+2 volts 3 amps, 28/-.

**SAVAGE'S**—Mains transformers V.T.35, 250-0-250 volts 60 m/amps, 2+2 volts 1 amp., 2+2 volts 3 amp., and, for automatically biased super power valve, 3+3 volts 5 amp., 33/-.

**SAVAGE'S**—Mains transformer H.T.3, 500-0-500 volts 120 m/amps, 3.75+3.75 volts 3 amps., 3+3 volts 3 amps., 2+2 volts 3 amps., 51/-.

**SAVAGE'S**—Mains transformers and power chokes are carefully and individually constructed from first class materials with an exceptionally generous margin of safety.

**SAVAGE'S**, 146, Bishopsgate, London, E.C.2. Phone: Bishopsgate 6998. [7976]

**RADIELLE** A.C. 200-volt R.K. Model Eliminator, cost £13/13, perfect order, complete with rectifying valves; £6.—H. Lousada, 9, Aubert Park, Highbury, London. [8091]

**EKCO** H.T. Eliminator, IV20, variable and power tapping, D.C. mains, unused prize; nearest offer £2.—104, Fairmead Av., Westcliff-on-Sea. [8087]

**MAJESTIC** Eliminator, input 200-250/50 cycles, output 200 volts, 30-35 m.a., 2 variables, 0-140; cost £7/15, sacrifice, £3/17/6, plus carriage; wanting higher output.—Whittle, 22, Luck Lane, Huddersfield. [8080]

**IGRANIC** H.A. Unit and Auto Charger Combined, practically new; cost £13/10, take £8.—Write Box 46, c/o 487, Finchley Rd., N.W.3. [8114]

CABINETS.

**ARTCRAFT** Radio Cabinets are Britain's Best Value. [0313]

**DIGBY'S** Cabinets.—Table models in solid oak and mahogany; from 11/6 to 71/-.

**DIGBY'S** Cabinets, fitted with Radion or Resiston chonite if required.

**DIGBY'S** Cabinets.—Pedestal model, with separate battery components; from 56/- to £12.

**DIGBY'S** Cabinets Made to Customer's Own Designs.

**DIGBY'S** Cabinets.—Write for new 16-page art catalogue.—F. Digby, 9, The Oval, Hackney Rd., E.2. Phone: Bishopsgate 6458. [0128]

**ARTCRAFT** Radio Cabinets; Britain's best value; lowest prices consistent with highest quality; illustrated list free from actual manufacturers.—Artcraft Co., 156, Cherry Orchard Rd., Croydon. Phone: Croydon 1981. [0040]

**KAY'S** Cabinets, the greatest range of pedestal cabinets in the kingdom; original creative designs at prices 50% lower than elsewhere; quotations for specials by return; delivery at short notice guaranteed; moving coil, portable, baffie, vignette, radiogram, electric pick-up, television, etc.; illustrated lists free.—H. Kay, Wireless Cabinet Manufacturer, Mount Pleasant Rd., London, N.17. Phone: Walthamstow 1626. [7745]

**ARTCRAFT** Radio Cabinets are Britain's Best Value. [0311]

**SLIGHTLY** Soiled Large M.C. Cabinets, approx. 18x18; from 17/6, usual price £2/2, upwards.—Goodmans, 27, Farringdon St., E.C.4. [8096]

**ARTCRAFT** Radio Cabinets are Britain's Best Value. [0309]

**EVERYTHING** in Cabinets.—Radio gramophone, £4/15; sideboard radio gramophone, £13/10; speaker cabinets, from 9/6.—Baker, 407, Hackney Rd., E.2. [8103]

**ARTCRAFT** Radio Cabinets are Britain's Best Value. [0310]

**THE UNIVERSAL THREE**



... the set that can't be improved!

At its introduction, far-seeing experts acclaimed the Universal Three a set that established previously unapproached standards—above the mere vagaries of fashion, free from all amateurish frills—that for the first time reached the highest peak in receiver performance. 12 months of progress has proved them right.

So inspired was its conception, so perfect its construction, that to-day—just as it was originally designed, without one single alteration—the Universal Three still stands alone, unique, unchallenged, supreme in every detail of performance.

For the "expert" amateur, the man who wants—and can recognise—the highest that radio can give, the Universal Three is the only satisfying set. A receiver on which, after over 12 months' progress and experiment, no improvement can be suggested, demands your investigation. Write for full details.

**The UNIVERSAL THREE**

15-2,000 metres.

The most perfect receiver yet designed for Ultra Short Wave, Broadcast, and Long Wave reception. Including Valves, Coils and Royalty.

£18-0-0

We specialise in all apparatus described in "The Wireless World."

Lists on Application.

**BURNE-JONES & CO., LTD.**

296, Borough High St., London, S.E.1.

**BONA FIDE TRADERS' GUIDE.**

Send for our comprehensive Illustrated List. QUICK SERVICE. QUICK SERVICE.

**THE QUALITY HOUSE.**

PERSEUS MFG. CO., LTD. (Dept. W.W.), BRANSTONE RD., BURTON-ON-TRENT.

**POLAR**  
THE CONDENSER WITH WIDE TUNING RANGE



Mention of "The Wireless World," when writing to advertisers, will ensure prompt attention.

**COILS, TRANSFORMERS, ETC.**

1,000-OHM Decoupling Resistances for "Wireless World" Circuits; 1/6 each, post free.—Groves Bros., St. Mary's Place, Shrewsbury. [7833]

**RADIOGRAPH**—W.V. coils, Record III, 35/-; new Kilo-Mag Four, 33/-; S.G. Regional, 37/6; foreign listeners' Four, 37/6 set; Europa Portable, 21/-; Europa III, 18/6; S.G. multi-valve portable, 22/6; new Everyman Four, 42/6.

**RADIOGRAPH**—Litz wire, 9/40, 1/6; 27/42, 2/6 dozen yards; Redfern's deep ribbed or Beol tube, 5d. per inch, slotting 1/6 extra.—Station Rd., Handsworth, Birmingham. [7914]

**600-OHM Decoupling Resistances** for New Kilo-mag Four, foreign listeners' four, and all "Wireless World" circuits, hand made and tested in our own workshops; improved model, 1/6 each, post free.—Groves Bros., St. Mary's Place, Shrewsbury. [7832]

**NEW Kilo-Mag Four Coils**, 37/6 set; ebonite formers (slotted), for winding, 12/6 set of 3; all post free; trade supplied.—Groves Bros., St. Mary's Place, Shrewsbury. [7975]

**SIMMONDS BROS.**—Berclif coils, Record Three, 50/- pair; new kilo-mag. four, 50/- set; foreign listeners four, low, 30/-; long wave, 37/-; screened grid Regional, 40/-; Mullard S.G.P. dual range coils, 30/- pair; Berclif standard coils, for new all-wave four, standard four, A.C. three, Everyman four, etc., 63/6 set of 4, with bases; the same coils for the Loestone series ("Wireless Magazine"), 65/9 set of 4, with bases; Titan unit, 15/-; decoupling resistances, 600 ohm, 1/6; 1,000 ohm, 2/-; all "Wireless World" and similar coils in regular production by the leading specialists; list free; trade supplied.—Simmonds Bros., Shireland Rd., Smethwick. Tel.: Smethwick 751. [6314]

**DYNAMOS, ETC.**

**M-L Anode Converter**, input 12v., output 300v. or 6v. to 150v.; £3/10.—59, Wellesley Rd., W.4. [8023]

**GRAMOPHONE PICK-UPS, ETC.**

**R.I. Varley**, with Meltrope arm; 25/-; approval.—Redgewell, "Penrhyn," Chartfield Rd., Reigate, Surrey. [8050]

**B.T.H. Pick-up**, 30/-; General Electric Universal gramophone motor, little used, £4/4.—Negus, Queen's, Oxford. [8067]

**RADIO-GRAMOPHONE**, oak pedestal, screened grid three, self contained batteries, double spring motor; £18.—9, Palgrave Rd., Stamford Brook, W.12. [8082]

**LOUD-SPEAKERS.**

**GREAT Bargains.**

**GREAT Bargains.**

**GREAT Bargains**—Epoch model A moving coil speaker kit (or complete units), brand new; a large number of these famous instruments made for a special order for use in talkies, but not executed, for credit reasons only; regular prices, £3/10, £4/2, and £5/17/6, to clear at 50/- for accumulator operation, 55/- for D.C. mains operation, 85/- for A.C. mains; kit comprising copper plated super magnet-pot (weight 2 1/2 lb.), Crystalene frame, fully adjustable, moving coil, any impedance, paper, leather and mounting rings, made up complete, if desired, 6/- extra.

**GREAT Bargains**

**ENJOY** Marvellous Epoch Reproduction at Ridiculous Cost; don't wait until they are all gone, but secure one immediately by writing, phoning, telegraphing, or hurrying to Epoch, 3, Farringdon Av., E.C.4. [7077]

**EPOCH**

**EPOCH Speakers** by Deferred payments.

**EPOCH.**

**EPOCH Speakers** by Deferred payments.

**EPOCH Famous Moving Coil Speakers**, any type, may be obtained by any responsible householder, by easy payments; no interest, no references no red tape as simple, easy and quick as paying cash.

**EPOCH.**

**EPOCH on the Easy**—Full particulars from Laser-son Ltd., Gramol House, Farringdon Avenue, E.C.4. [7919]

**NIKOLA Cones**; 3/-, 3/6, 4/-, 4/6; manufacturers' type, standardised; floating on leather.—Particulars from Knight and Co., 6, Chapel St., London, E.C.2. [8015]

**PERARDUA Moving Coil Reproducers**—Cabinet models, 230-volt D.C., £5/5; 6-volt, £5; chassis only, £3/3 and £3 respectively; state output valve.—R. Vevers, 4, York Rd., Maidenhead. [7968]

**BAKER'S SELHURST RADIO** 36-page Booklet, "Sound Advice is Yours for the Asking"; write now for new edition; see displayed advertisement on page 21. [0231]

**BLUE Spot Cabinet Speaker**, £3/5; Ecco mains unit, 20 m.a., 30/-, new.—2/31, Saltley Rd., Birmingham. [8047]

—a tone-perfect production  
—a friend of good Records!



Scientifically designed, beautifully made, The MELTROPE Sound Box gives perfect tone and wonderful service, and will bring the oldest gramophone up to date!

Price **12/6.**

Made by

**AMPLIFIERS LTD.,**  
BILLET ROAD, LONDON, E.17.

Suitable for all types of tone arm.

**"B.A.T." 750 Watt "Q.M.B." SWITCH.**

This miniature switch comfortably breaks 3 Amperes at 250 Volts. For H.F., L.F., H.T., L.T. Circuits. For A.C. Sets, Eliminators, Gramophones, and as Loud Speaker Field Switch, etc.

"WIRELESS WORLD" said (14.8.29) "functioned quite well on test and did not give any cause to justify doubt as to their ability to handle this wattage" (750 Watts!). "Ideal for use in portable sets and in all types of mains equipment."

"B.A.T." "Q.M.B." POWER SWITCH only 2/6 Each.



**CLAUDE LYONS LTD.,**  
76, OLDHALL STREET, LIVERPOOL.

**METAL CABINETS**

Complete with Base for 1930 Everyman Four, New Kilomag Four, and W.W. Record III. Jacobean Finish.

TERMS: CASH WITH ORDER Price 57/6.

**RIGBY & WOOLFENDEN,** SHEET METAL WORKERS,  
MILNROW RD., ROCHDALE.

**REPAIRS**

Any make of L.F. Transformer, Loudspeakers or headphones repaired and dispatched within **48 HOURS—TWELVE MONTHS' GUARANTEE** with each repair. 4/- Post Free.

Terms to Trade.

**TRANSFORMER REPAIR CO.,**

Dept. W.,  
214, High Street, Colliers Wood, London, S.W.1





## Permanent Magnets for Construction of Moving Coil Loudspeakers.

As specified in "Wireless World," Jan. 15th.  
No field coil to energise.



Delivery from Stock.

**£4.0.0**

including cylinder for coil former and screws.  
In 35% Cobalt Steel, 8,000 lines per square cm. in 1½ mm. gap.

Cradle and other parts necessary to complete Loudspeaker, £1 extra.

Mounted Complete ready to fix to Baffle Board **£5.7.6**

**A. M. E. SHERWOOD,**  
NEW ADDRESS  
66, Hatton Garden, London, E.C.1.  
Phone: Holborn 1280.

## WE SPECIALISE IN MAKING PURCHASES FOR OVERSEAS READERS

Parts, Speakers, Eliminators, or complete Sets. We can buy them for you and what is more will see to it that your requirements are met in every way.

### HOW TO ORDER

Enclose money order to the approximate amount of the purchase and add 5% to cover freight, Insurance, etc.

**THE OVERSEAS TRADING CO.,**  
144, St. Vincent Street, GLASGOW,  
Scotland.  
Telegrams: "Tenacity," Glasgow.

**TWIN CONE KIT OF PARTS** 2/6

For a Double Linen Diaphragm Speaker  
Steel chassis built, adjustable damping attachment.  
Size 20" square. Takes any popular movement.  
**GREEN & FAULCONBRIDGE, LTD.,**  
11, QUEENS ROAD, COVENTRY

### Loud-speakers.—Contd.

**A**S New, Brown Vee chassis cone, 30/-; Amplion Lion chassis, £4; moving coil 6v. Baker suspension, 50/-; Watnet cone kit, 22/6.—BM/DRIEX, London, W.C.1. [8042]

**C**ELESTION Loud-speaker, oak, model C12; accept £3/3.—Hillside, Brigsley, near Grimsby. [8048]

**S**ELF-CENTRE, a device when fitted to your speaker unit will relieve driving rod of undue side stress centering cone to driving rod thus improving results, ideal for linen speakers, easily fitted; price 2/6; c.o.d.; terms available.—Weedon, 80, Lonsdale Av., London, E.6. [8040]

**L**OUND-SPEAKER Units, Hegra balanced armature, 10/6; Triotron. 6/6; Blue Spot 66A, 12/6; large assortment second-hand units of various makes and types; Hegra D.C. mains M.C. speaker, with transformer, 45/-; various odd sized moving coil pots, remains of special order, 12/6, unwound; state requirements.—Goodmans, 27, Farringdon St., E.C.4. [8095]

**A**MATEUR'S Lion Amplion, solid mahogany Concert cabinet, space for pick-up; gift, £7/10.—After 7, Carter, 3, Grange Rd., Kenton, Harrow. [8111]

**T**WINMAG.

**T**WINMAG.

**T**WINMAG.

**W**RITE for Particulars of Goodmans' New Super Double Magnet Balanced Armature Unit.—Goodmans, 27, Farringdon St., E.C.4. [8100]

**F**INEST Suspension Leather, for fixing cones to moving coil or reed units, as supplied to principal makers; 2/- sq. ft., 1/6 10in. square; segments up to 12in. cone 9d. for 4; all post free, cash with order.—Dilley, 8, Ashby Rd., Essex Rd., N.1. Chisold 0736. [8093]

**B**BROWN H4, 8/6; also Igranite micro-condenser, 2/6, perfect.—21, Alexandra Rd., Chesterfield. [8081]

**G**ET Moving Coil Quality Liner Diaphragm Speaker, varnished ply, 17/-; polished mahogany, 25/-; handsome appearance, fit any unit.—Parke, 79g, Turnpike Lane, London, N.8. [8079]

**L**ISSEN Permanent Magnet Moving Coil Speaker, with Lissen output trans. (6:1 ratio) bolted on base, never been unpacked; sacrifice, £5.—Owen T. Llewellyn, Wercham Rd., Stoke Ferry, King's Lynn. [8073]

**E**XPONENTIAL Horn, 2ft. square, on stand, extremely suitable for schools or demonstration; £10, or near offer.—Roed, South Lodge, Champion Hill, S.E.5. [8068]

### PICTURE RECEIVER APPARATUS.

**B**RAND New Genuine Fultograph, complete; original price £24, accept £10 cash.—Wood, 100, Aston Rd., Birmingham. [8026]

**F**ULTOGRAPH Machine, brand new, complete, perfect order; bargain, £5.—R. Mansi, 44, Church Rd., Southgate Rd., N.1. [8084]

### TRANSMITTERS.

**C**CHEBROS. Chebros. Chebros transformers and chokes of all descriptions, special transformers for transmitting and modulation; chokes a speciality; enquiries invited.—Chester Bros., 244, Dalston Lane, London, E.8. [5240]

### VALVES.

**A**AMPLIFIER Valve.—If you require power you cannot do better than one of these:—

**F**ILAMENT Volta 6, plate volts 400 (maximum), grid bias 84 volts (approx.), impedance 800 ohms, amplification factor 3.8, mutual conductance 4.35 m.a./volts; price £5/10; see article "The Wireless World," 24th July, 1929, then send to North London Valve Co., Ltd., 22½, Cazenove Rd., Stoke Newington, London, N.16. [7917]

**D**U2 Mullard, full emission, makers' report produced; offer.—40, Harrington St., N.W.1. [8034]

**M**MARCONI P625, 1/-; H.L. 610, 5/-; Mullard P.M. 5X, 5/-; B4, 5/-.—Brooklyn, Fursby Av., Finchley, N.5. [8031]

**T**TWO P.M. 24A, perfect, used 6 hours; 33/-.—Box 4552, c/o The Wireless World. [8022]

### COMPONENTS, ETC., FOR SALE.

**B**BELLING-LEE Panel Fittings are designed to give an expert finish to any home-constructed set; catalogue post free.—Belling and Lee, Ltd., Queensway Works, Ponders End, Middlesex. [0018]

**P**OWER Chokes, substantially built, for smoothing circuits in eliminators dealing with currents 100-300 milliamperes, inductance .30 henries; 8/6 each; guaranteed 12 months.—Transformer Repair Co. (Dept. W), 214, High St., Colliers Wood, S.W.19. [0327]

**W**ESTON Model 301, milliammeters, ammeters, and voltmeters. 21/- each; hot wire ammeters 0-1 amps., 4/-; 0-0.5 amp., 3/-; instrument repairs and alterations; send for list.—The Vieta Electrical Co., 47, High St., Battersea, S.W.11. Established 1910. [7563]



From "The Amateur Photographer."

## For Every User of a Camera!

Every camera owner can get more pleasure out of photography and better results by reading "The Amateur Photographer" regularly.

The "A.P." caters for all photographers, including beginners and advanced workers, and contains Lessons for Beginners; Free Criticism of Readers' Prints; Answers to Queries; Regular Competitions and a weekly Art Supplement of particular interest to pictorial workers.

**The AMATEUR PHOTOGRAPHER**  
& CINEMATOGRAPHER  
The Journal for Everybody with a Camera

Every Wednesday 3d.

**LILIFFE & SONS LTD.,**  
Dorset House, Tudor Street, London, E.C.4.  
W.W.37a.

**NEW  
SUPER-MICROPHONE  
CRYSTAL  
AMPLIFIER**

28/-

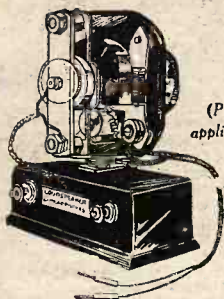

(Patent applied for)

Amplifies weak Signals to good Head-phone Strength and good Headphone Strength to good Loudspeaker Volume.

Requires only one or two Dry Cells to work. No other Accessories needed. Robust Construction. No Fragile Parts.

Initial Cost and Upkeep very much less than a Valve Amplifier of the same Volume.

Directions for use, free.

FREDK. ADOLPH, Actual Maker, 'Phone: Museum 27, Fitzroy Street, London, W.1. 8329

**THE PILOT  
VOLUMGRAD**



A HIGH RESISTANCE POTENTIOMETER especially designed for volume and oscillation control, a solution to all problems of volume control. Can be used across the terminals of a Gramophone Pick-up. Volume is adjusted from zero to maximum with one turn of the knob.

IN FOUR RESISTANCES:—

50,000 Ohms	EACH
100,000 "	<b>6/6</b>
200,000 "	
500,000 "	

**USE PILOT COMPONENTS**

Write for Catalogues to:—

**THOMAS A. ROWLEY Ltd.**  
59, Skinner Lane, Birmingham  
Sole Agents for Great Britain and Ireland.

West of England Distributors:—F. BURRIS & SONS, 7 to 16, REDCLIFFE ST., BRISTOL.

**Components, Etc., for Sale.—Contd.**

POTENTIAL Dividers 10,000, 15,000, 20,000, 25,000 and 30,000 ohms, 5 variable tappings: 2/- each.

POTENTIAL Dividers, heavy duty, wire wound, 15,000 and 20,000 ohms, 7 tappings, 5/6; 4 tappings, 3/9.

CONDENSERS, 2 mfd., 2/3; 4 mfd., 4/-; guaranteed; tested 500 volts.

CHOKES (L.F.).—Excellent for smoothing, up to 20 milliamps, 2/-; special heavy duty, 100 milliamps, 8/6.

ELIMINATORS, A.C., wired for half or full wave, complete with valve; £3/17/6.

H.F. Chokes; 3/-.

GRAMOPHONE Motors, well known make, double spring, silent, complete with fittings; 30/-.

SPECIAL Bargain.—B.T.H. 40 henry chokes; 9/6; any article on approval against cash.—Huggins, Radio Engineers, Clacton-on-Sea. [7398]

600-OHMS Decoupling Resistances; see advt. under Coils.—Groves Brothers, Manufacturers. [7751]

REMOTE Control Relays, new, not ex-W.D.; send 10/- P.O., stating accumulator voltage, to F. W. Hughes, 17, Blackheath Vale, London, S.E.3 [7944]

**APPLEBY'S Bargains.**

THE Following Slight Used Material is Offered Subject to Sale; every article will be severely tested before despatch, and guaranteed in workable condition; items are nett cash and carriage paid in Great Britain.

RESIDUE of Transformers.—Ferranti A.F.5, 19/6 each; Ferranti A.F.3, Marconi Ideal, R.I. Straight Line, Mullard Permacore, Phillips, all one price, 14/- each, limited number.

RESIDUE of Pick-ups.—Woodroffe, 45/-, 35/- and 25/- each; R.I. Varley, 25/-, 20/- each; Brown, best model 45/-, 30/- each, prices depending upon condition; smaller Brown, Igranico Phonovox, Amplion Vivavox, G.E.C., Burndep, all one price, 14/- each, limited number; Blue Spot and arm, 27/6; B.T.H. and arm (straight), 32/-; arms, Raytrak, 19/6; Watmel, 4/9.

NOW.—Send now; many clients were disappointed by material having been sold previous to their application for goods lately.

APPLEBY'S, Number Forty-four, Chapel St., Marylebone, N.W.1 (4 minutes from Oxford St., London). [0316 don.]

WESTINGHOUSE H.T.1 Rectifier, with Partridge transformer, 200-240 volts, Weston milliammeter, bakelite flush case, 100 m. amps, ditto 200 m. amps, all above never used; half list price.—Box 4550, c/o The Wireless World. [8020]

FERRANTI Milliammeter, 0-150, unused, 22/-; Hunt, 0-50, 10/-; Pye mains transformer 230, for Westinghouse H.T.1, 15/-; Pye 32H Choke, 7/-; Silver Marshall superhet kit, 10/-; Bodine loop, 10/-; Exide 2v. 50, 7/6; 5 Ferranti 2 mfd., 1,000 volt, 3/6 each; T.O.C. and Dubilier 2 mfd., 2/- each; 0.01 mica, 2/-; resistances, Ferranti and Varley, including holders, 200,000, 5/-; 50,000, 30,000, 25,000, 15,000, 6,000, 3,000, 3/- each; Ormond dials, 2/-; American apex, 2/-; Polar 0.0001, unused, 4/-; almost new valves, P.625A, 10/-; P.M.254, 10/-; X.P.415, 8/-; P.M.24, 15/-; Marconi moving coil speaker, perfect condition, £3/15.—Brockwell, 57, Canford Rd., S.W.11. 'Phone: Battersea 6582. [8028]

A NODE Converter, M-L, type O, 12 volts input, output 300 volts, also complete set of tropadyne superhet transformers; what offers —KiaOra, The Cambridge Rd., Tottenham, N.17. [8029]

AMPLION Lion, £6; chassis, 70/-; Dubilier 0.0002 reaction, 3/-; pick-ups, Burndep 14/-, Loewe 12/-; valves, L.F.607 5/-, P.M.26 12/-; all guaranteed perfect.—Briggs, Carlton Rd., Shipley. [8036]

EXPERIMENTER has Surplus Valves for Sale.—Cosmos A.C., Mullard, and Rectifying valves, eliminator components, transformers, and pick-ups, all as new; state requirements.—Box 4603, c/o The Wireless World. [8054]

BANKRUPT Stock, new and guaranteed.—Ready Radio Selectivity units, 10/-; transformers, R.I. Hypermu, 15/-; Nicore 11, 7/6; Bullphone, 5/-; D.X., 5/-; Telsen radiogram, 3-1, 5-1, 9-1; Dubilier E.C. units, 5/6; satisfaction or money refunded; cash with order or c.o.d.—Spencer, 12a, Sheep St., Northampton. [8057]

COMPONENTS Lent on Hire; send for details.—Alexander Black, The Wireless Doctor, 55, Ebury St., S.W.1. Sloane 1655. [0329]

RADIO HOUSE, Huddersfield, issues the Reliability Wireless Guide, which will be sent post free upon request by Messrs. J. H. Taylor and Co., 15, Macaulay St., Huddersfield. [7823]

YOUR Old Components Taken in Part Payment for Latest Type; see our advert. in column Receivers for Sale.—Scientific Development Co., 51, Fishergate, Preston. [0228]

CLIMAX Auto-bat Transformer, 15/6; two R.H.I. valves, 15/6; B.T.H. electric gramophone motor, 85/-; pick-up and tone arm, 32/6; all as new.—Box 4620, c/o The Wireless World. [8109]

**The Music  
Lover's Choice!**



**BAKER'S**

**1930 SUPER POWER MODEL**

Proved by independent Laboratory tests to be the most highly efficient Moving Coil Loud Speaker manufactured to-day. A simple two-valve receiver is all that is required.

TOTAL  
FLUX  
**206,000**  
LINES

FLUX DENSITY IN AIR GAP:  
**13,050**  
LINES PER SQ. CM.

Full reports of tests carried out by the NATIONAL PHYSICAL LABORATORY, TEDDINGTON are now available.

Buy a "BAKER'S" Super Power Moving Coil Loud Speaker and be more than satisfied. It is British throughout.

Write for 36 page Booklet "Sound Advice" now. New edition just out.

**BAKER'S  
'Selhurst'  
RADIO**

The Pioneer manufacturers of Moving Coil Loud Speakers.

Head Office: 89, Selhurst Road, South Norwood, London, S.E.25

Works and Demonstration Room: 42, Cherry Orchard Road, East Croydon.

'Phone: 1618 Croydon.

**POPULAR FIFTY  
ACHIEVES WONDERS**



**50%**

**WITH FAMOUS DOUBLE  
LINEN DIAPHRAGM**

Scientifically balanced for area and mutual tension. Even frequency response. Music, speech and song with lifelike volume, atmosphere, character, vitality and vividly natural. If your dealer cannot supply send his name and address to manufacturers,

**ULTRA ELECTRIC LIMITED,**  
661 Harrow Road, London, N.W.10.



Baldry Ad. U149.

**"SCIENTIFIC"**

Reinforced  
Non-Metallic

**RE-ENTRANT HORNS**

Ideal for Gramophones  
Radio-Gramophones or  
Wireless Loud Speakers



Size 13x12x16 ins.	19/6
13x15x16 ins.	23/6
17x17x16 ins.	25/6

Carriage Forward.

Latest Type Tone Arm	8/6
Corrugated Diaphragm Sound Box	8/6
Balanced Armature Unit	19/6

**SCIENTIFIC SUPPLY STORES**

126, Newington Causeway, London, S.E.1.  
Phone: Hop 4177.

**Components, Etc., for Sale.—Contd.**

**SIFAM** Double Range Moving Coil Meter, 0-6, 0-180v., 27/6 model, 16/6; new Brown A type headphones, £1 pair; Edison Bell pick-up, 5/-; Lotus remote control eliminator, model H.T. and L.T. combined, 25/-.—Goodmans, 27, Farringdon St., E.C.4. [8097]

**COPPER** Radio Earths, square section, 2ft.x1½in., with long copper connecting strips, these are super earths; each returned if not approved; price 3/6 each, postage 6d.—Soar, 23, George Lane, Lewisham, S.E.13. [8115]

**FOR Sale**—1 D.E.5, 2 D.E.5B.s, 2 I.S.5s, 1 D.E.L.610, 1 H.L.210, all practically new, 35/-; 1 R.I. and Varley L.P. transformer (6 terminal model), 7/-; 1 Burndept choke, 40 henries at 50 m.a., 7/6.—Write Box 4621, c/o *The Wireless World*. [8110]

**ORGOLA** Senior Kit of Condensers, on panel, and coils (taught); £2/15.—Box 4619, c/o *The Wireless World*. [8108]

**OSRAM** Valves, little used, D.E.H.210, D.E.L.210, 4/- each; 2 D.E.P.215, 5/- each, as new; Ferranti A.F.4, 9/-; Mullard R.C.C. unit, 5/-; R.I. anti-mobo, 3/-; offer 10/- lot.—Boakes, 12, Copperfield Rd., Coventry. [8086]

**WIRELESS** Transmitting Sets for Morse Telegraphy or distant Control of Models, etc., 1in. spark coil, condenser, spark gap, helix, etc., very compact, complete and ready for use, 12/6; high note buzzer with heavy Morse key, very high quality, 7/6.—Below.

**ELECTRIC** Motors, ¼h.p. to ½h.p., 110v. and 220v. D.C., silent running, carbon brushes, in perfect condition and working order, suitable for gramophones, television, or any small power uses, 10/-; a few with overrated windings, if rewound make good dynamos for H.T. accumulators, 6/-.—Below.

**COMPLETE** Portable Telephones, ready for use, high class instruments, 17/6; hand telephones, 4/6; 1,000 ohm choke coils, 1/-; Dewar switches, 1/-; large earphones, 1/3; Morse keys, 4/-.—Below.

**HIGHLY** Sensitive Microphones for Transmission of Speech or Music or Sensitive Amplifying, 2/6; microphone transformers to suit, 2/6; microphone buttons, 1/-; G.P.O. relays, 2,000 ohms, very sensitive, very low operating current, 6/8.—Below.

**2IN.** Spark Coils, 11in.x7in.x6in., complete with contact breaker and condenser, 12/6; 1in. spark coils, 4in.x4in.x5in., fully complete, 6/-; Ford ignition coils, 3in. spark, complete, 4/-.—Below.

**DYNAMOS**, shunt wound, for charging or lighting, 50v. 4 amp., ring oiler bearings, carbon brushes, 35/-; 100v. 3 amp., ditto, 50/-; 110v. 3 amp. ball bearing, carbon brushes, 55/-; 110v. 2 amp. ditto, 45/-.—Below.

**ELECTRIC** Motors, all ball bearing and carbon brushes, ¼h.p. to ½h.p., 110v., 30/-; 6-volt car starter motors, 10/-; 12-volt ditto, 12/6; 110v. motor direct coupled to air blower, mounted on iron bedplate, ¼h.p. motor, 45/-.—Below.

**STARTERS**, please state requirements; starter regulators make good field rheostats for dynamos, to carry 2 amps., 7/6, to carry 5 amps., 10/-, to carry 8 amps., 12/6.—Below.

**ALL** Above Goods Guaranteed, cash with order, or c.o.d., all goods 3 days' approval from date of delivery; all letters answered.—Galpin, Binfield Heath, near Henley-on-Thames. [8085]

**BROWN'S** F Type Headphones, new and unused; cost £1, accept 12/6; Igranio E transformer, as new 6/-.—R. Minchin, Norcot Farm, Reading. [8078]

**CONSTRUCTORS** Contemplating an Adjustment or Construction of a Receiver, should enquire for our comprehensive components, and reproducer lists.—P. O. Davies, 31, Abbey St., Tower Bridge, S.E.1. [8076]

**D.C.** Eliminator, 220/80, 4.1 Marconiphone transformer, 2 variable 0.0005 condensers, 200,000 ohm Mullard resistance, fl. res. Igranio; lot 27/6.—Meadowcroft, Rio, Shanklin, I.-of-W. [8066]

**MISCELLANEOUS.**

**ALEXANDER BLACK,**

**THE** Original Wireless Doctor, will call (London and Home Counties) and cure your set.

**CONSULTATIONS** by Appointment Without Obligation, sets installed, maintained, and brought up to date, gramophone pick-ups, eliminators, and Webson moving coil speakers demonstrated; purity reproduction specialist.

55, Ebury St., Victoria, S.W.1. Sloane 1655. [0277]

**EASY** Payments.—We supply, by easy payments, components, accessories, and sets, any make; 10% down, balance spread over 10 months.—Send list of requirements to London Radio Supply Co., 11, Oat Lane, London, E.C.2. [0097]

**WIRELESS** Notes.—A monthly service of information for all those who want the very best in wireless or gramophone reproduction; frank criticism of receivers and components; immediate postal help and advice in all difficulties; something new and unique; you must have it if you want to know the truth.—Full particulars free from Ernest H. Robinson, Langmead, Pirbright, Woking, Surrey. [7607]

**Layerbilt**  
- every inch  
a battery!

Every inch of the "Layerbilt" Battery is a store of electricity. The Columbia patented process of building layer upon layer of flat cells gives "Layerbilt" 1½ times the electrical capacity of any other battery of equal size and weight. The increase in its life is even greater. "Layerbilt" is the best and most economical battery in the world. Buy "Layerbilt" now—don't risk spoiling your programme with exhausted batteries.



"Layerbilt" No. 4486, No. 4721, 80  
for 18 m.a., 25/- volts, 10/6  
No. 4780, 60 volts, No. 4755, 60  
20/- volts, 18/-

25/-

**Columbia**  
**RADIO BATTERIES**

J. R. MORRIS, Imperial House,  
15, Kingsway, London, W.C.2.

Scotland: J. T. Cartwright, 3, Cadogan St., Glasgow.

**DOMINION**  
**VERNIER DIALS**



**2/6**

Only Brownie's ability to produce 2,000 Dominion Vernier Dials a day enables them to keep the price as low as 2/6. The special non-backlash design (for fine tuning) and the splendid finish (smooth black or beautifully grained mahogany bakelite) coupled with the low price, makes the Dominion Vernier Dial a real radio bargain.

BROWNIE WIRELESS COMPANY (G.B.) LIMITED,  
NELSON STREET WORKS, LONDON, N.W.1

**BROWNIE**  
**WIRELESS**

Mention of "The Wireless World," when writing to advertisers, will ensure prompt attention.

Miscellaneous.—Contd.

**SCOTT SESSIONS and Co.**, Great Britain's radio doctors, officially approved as wireless repairers by Radio Society of Great Britain and Wireless League; old sets of every type repaired, rebuilt, modernised; send set for immediate quotation. [0262]

**SCOTT SESSIONS and Co.**—New sets constructed with your or our components, guaranteed finest workmanship; we specialise in "The Wireless World" circuits; remember, we have satisfied customers throughout the British Isles and in three Continents; if you so desire, we will design and construct high grade apparatus to suit your special circumstances for quality, range and selectivity.—Tel.: Tudor 5326. Muswell Hill, London, N.10. [0262]

**K. HAYNES, B.Sc.**, 26, Ashley Hill, Bristol, buyer for home and overseas experimenters, all components tested before despatch. [8070]

**G. BOLTON**, radio doctor.—Faulty sets quickly cured, repairs, maintenance; moderate charges. 221, Cavendish Rd., Balham. [8064]

PATENT AGENTS.

**PATENTS and Trade Marks**, British and foreign.—Gee and Co (H. T. P. Gee, Member R.S.G.B. and A.M.I.E.E.), 51-52 Chancery Lane, London, W.C.2. Phone: Holborn 1525. [0001]

REPAIRS.

**SCOTT SESSIONS and Co.**, Great Britain's radio doctors; read advertisement under Miscellaneous column. [0263]

**TWELVE Months' Guarantee** Accompanies all our repairs; any make of L.F. transformer, headphones, or loud-speaker repaired and despatched within 48 hours; 4/- post free; don't discard if burnt out; terms to trade.—Transformer Repair Co., (Dept. W.), 214, High St., Colliers Wood, S.W.19. [0011]

**GUARANTEED Repairs by Experts.**—Loud-speakers, headphones, cone units, pick-ups, any type, re-wound, remagnetised, and adjusted, post free 4/-; transformers, from 4/-.—Howell, 91, Morley Hill, Enfield, Middlesex. [7882]

**SEND Your Loud-speaker Repairs to Goodmans.**—Moving coils re-wound, etc.—Goodmans, 27, Farringdon St., E.C.4. [8098]

**REPAIRS Returned Post Free**, and to ensure satisfaction send remittance after approval of same.—Leeds Wireless Repair Service.

**LOUD-SPEAKERS**, headphones, re-wound to any resistance and remagnetised, 3/-; transformers re-wound, 4/-; Blue Spots, Triotrons and 4-pole units, 4/6; work guaranteed.—Leeds Wireless Repair Service, 5, Boston Place, Green Rd., Leeds. [8101]

WANTED.

**WANTED**, "Wireless World," April 2, 1921, June 4, 1924, January 14, 1925, and "Q.S.T.," September, 1923.—Hugh Ryan (5BV), Woodhays Rd., Wimbledon Common, London. [8060]

**WANTED**, all mains receiver for D.C.220.—Box 4604, c/o The Wireless World. [8055]

**WANTED**, 0.0005 Ormond or Lotus all brass variable S.L.F. condenser, also Ormond S.M. dial, black preferred.—58, Uplands, Stoke Heath, Coventry. [8027]

**SILVER Marshall, G.R.C.**, intermediate transformers, oscillators, iodine, aero frames.—BM/ENFA, London, W.C.1. [8033]

**WANTED**, Philips 4, voltage 10.5 A/C, 50 periods, with loud-speaker, perfect condition.—Box 4617, c/o The Wireless World. [8106]

**WANTED**, Westinghouse metal rectifier, A3-A4.—W. Griggs, 61, Wyndham Rd., Dover. [8065]

**WANTED**, back numbers of Vols. 21-25 "Wireless World."—Box 4618, c/o The Wireless World. [8107]

EXCHANGE.

**MCVOY** Combination, 350 c.c., 1928, £40; or exchange Record Three, B.T.H. motor, B.T.H. R.K. 100 v. speaker, B.T.H. pick-up, A.F.5C, O.P.40, and cash adjustment; stamp reply.—97, Hanover St., Castleton, Rochdale. [8045]

**PHOTOGRAPHIC** outfit, cost £35, or old violin, Volin bow, steel case, worth £20, for modern radio gramophone.—Morris, 8, Marnion Rd., Hove, Sussex. [8030]

**W.W. Kit Three**, Ritto cabinet, Wearite coils, B. and J. dials, Polar condensers, un-assembled; offers or exchange radio gramo. apparatus.—18, Clifden Rd., St. Anstell. [8061]

**YOUR Old Apparatus Taken in Part Payment** for Latest Type; see our advert. in column Receivers for Sale.—Scientific Development Co., 51, Fishergate, Preston. [0230]

The finest Loudspeakers in the world in their class  
**EPOCH**  
Moving Coil Speakers.

Models 99 and 66 are the standard of comparison in many of the famous laboratories of the world. The speakers that have made Radio as enjoyable as the best concerts. 14 different models for all requirements, from £2 10 0 upwards.

Write for Booklet W.S. giving full particulars and the 7 days free trial offer.



Our Latest Triumph!  
**Epoch**  
Super-Cinema Model

The most powerful speaker ever put on the market, and the most sensitive too! Many times as sensitive as an ordinary moving-coil speaker. Such superb quality has never been heard before. Delivers enormous volume and wonderful quality from the most modest of sets. The speaker for the home, public entertainments or Talkies!

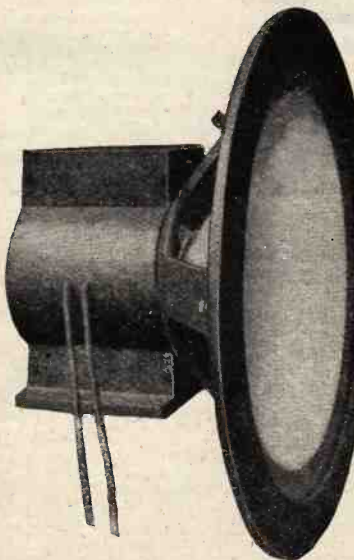

**EPOCH RADIO MANUFACTURING CO., LTD.**, are the manufacturers.

City Office & Service Station: 3, Farringdon Avenue (Ludgate Circus end), E.C.4.  
Phone: Central 1971 (2 lines). Private Branch Exchange.

Exchange.—Contd.

**MANCHESTER**, January 10, 1930.—Dear Sir,—Received this morning the remainder of my parts. Thank you again for the trouble you have taken in getting me the exact things. Will most certainly recommend you to my wireless friends, as I have been so pleased with the deal. We do not ask for compliments, we endeavour to earn them. Before buying your new set or components, offer us your unrequired articles.—Bostock and Stonnill, 1, Westbourne Terrace, Park Rd., Forest Hill, S.E.23. [8089]

**LEWCOS S.G. Coils** (35/-) for 66K unit and chassis; Ormond unit, 7/.—Heckman, 8a, Thorndean St., Earlsfield. [8077]

**AMPLION** Cone Speaker Offered for H.M.V. Table Grand or Good Records; cash adjustment.—Write A. J. R., 19, Sainfoin Rd., S.W.17. [8074]

**MULLARD H.T. Unit**, 230 volts, new, £4; Utility 3-pole, 4/6; 100,000 resistance, 5/-; headphones, 5/-; Brookmans reactor, 7/6; wanted, electric gram. motor, mains C.A.C. coupler, A.C. valves, moving coil permanent magnet, measuring instrument.—Jackson, Lodge, Crookhill Hall, Conisbrough, Rotherham. [8071]

BUSINESSES & PROPERTY FOR SALE, TO BE LET, OR WANTED.

**PROGRESSIVE** Wireless Business, turnover over £2,000 per annum, South West England; living accommodation; low rent; £250.—Box 4607, c/o The Wireless World. [8059]

**EXCELLENT** Opportunity for Wireless Accessories.—Lock-up shop, well decorated, large window, splendid position, electric light and power, opposite Church End Finchley Station; 30/- per week.—Apply Station Rd., Finchley, N.3. [8102]

SITUATIONS VACANT.

**RADIO** Mechanic Required, must possess advanced practical and theoretical knowledge and be businesslike and efficient worker; state age, salary, and experience.—Box 4483, c/o The Wireless World. [7934]

**REPRESENTATIVES** (whole time) Wanted for Wireless Components and Sets (only those with first class wireless sales experience entertained); appointments to be on salary basis plus commission.—Apply, with full details regarding wireless sales experience, whether you can drive a car, minimum remuneration required, age, and which territory preferred or where best known, Box 4530, c/o The Wireless World. [7998]

**AN** Excellent Opportunity Occurs for a Public School boy, anxious to succeed, to acquire practical knowledge of wireless, age under 21.—Apply, by letter only, Alexander Black, 55, Ebury St., S.W.1. [8043]

**SITUATIONS** Guaranteed as Wireless Operators, age 15-30, day, evening, postal courses; boarding students fee payable after situation found.—School, 321, Mansfield Rd., Nottingham. [8038]

**CALEDONIAN WIRELESS COLLEGES** Invite Applications for the Appointment of Technical Lecturer at Edinburgh.—Applications (in writing), giving full particulars of training, experience in radiotelegraphy, along with one copy of testimonials, should be addressed to Managing Director, 24, India St., Glasgow, C.2. [8025]

**WANTED** for Service Department of Well Known Radio Manufacturers, technical assistants familiar with tracing faults and repairing A.C. mains receivers; good technical knowledge essential.—Write, giving full particulars, salary, etc., to Box 4616, c/o The Wireless World. [8105]

SITUATIONS WANTED.

**TO** Manufacturers.—Radio engineer, having sound theoretical qualifications and practical experience in set design, production, maintenance and service, excellent knowledge of book-keeping, commercial methods and costing, possessing initiative, energy and organising ability, desires post with manufacturers of repute.—Box 4551, c/o The Wireless World. [8021]

BOOKS, INSTRUCTION, ETC.

**STEP** by Step Wireless: a complete course of the theory of electricity in relation to the practical design of wireless apparatus, eliminators, circuits, etc., with extracts from a designer's notebook, giving up-to-date practical application; issued weekly; send 1/- p.o. for first 4 weeks.—Clifford Pressland, A.M.I.E.E.Eng., Dept. W.W., Hampton-on-Thames. [0195]

**FREE:** Inventor's Guide on Patents.—T. A. A., 253 (W), Gray's Inn Rd., London, W.C.1. [6373]

**ACCUMULATOR** Charging, Maintenance and Repair By W. S. Ibbetson. A handy guide to the charging and upkeep of accumulator for wireless work or motor cars; 3/6 net.—Of booksellers or Pitman's, Parker St., Kingsway, London, W.C.2. [7068]

447 Advertisements for "The Wireless World" are only accepted from firms we believe to be thoroughly reliable.

INDEX TO ADVERTISEMENTS.

	PAGE		PAGE		PAGE
Adolph, Fredk.	21	Ferranti, Ltd.	3	Player's	5
Amplifiers, Ltd.	18	Garnett, Whiteley & Co., Ltd.	19	Potter, H. B., & Co., Ltd.	10
Apleby, E. Hetherington	16	Graham Parish	7	Radiogramophone Development Co.	10
B. & J. Wireless Co.	16	Green & Faulconbridge, Ltd.	20	Radio Instruments, Ltd.	14
Baker's "Selhurst" Radio	21	Grosvenor Battery Co., Ltd.	iii	Rigby & Wooltenden	18
Bayliss, W., Ltd.	Cover iii. & p. 10	Holzman, L.	4	Rothermel Corp., Ltd. (Electrad)	6
Belling & Lee, Ltd.	24	Jackson Bros.	17	Rowley, Thomas A., Ltd.	21
British Insulated Cables, Ltd.	11	Lesingham, F. L.	19	Scientific Supply Stores	22
Brownie Wireless Co. (G.B.), Ltd.	22	London Electric Wire Co. & Smiths, Ltd.	8	Sheffield Magnet Co.	1
Bnigin, A. F. & Co.	24	London Radio Supply Co.	8	Sherwood, A. M. E.	20
Burne-Jones & Co., Ltd.	18	Lyons, Claude, Ltd.	18	Simmonds Bros.	24
Burton, C. F. & H.	6	Marconiphone Co., Ltd.	15	Squire, Fredk., Ltd.	4
Celestion, Ltd.	2	McMichael, L., Ltd.	16	Telegraph Condensers Co. Ltd.	Cover i. & p. 2
Cole, E. K., Ltd.	Cover i.	Melhuish, C. D.	16	Thomas, Bertram	24
Coscor, A. C., Ltd.	12	M.L. Magneto Synd., Ltd.	9	Tonex Co.	24
Day, Will, Ltd.	6	Morris, J. B.	22	Transformer Repair Co.	18
Dubilier Condenser Co. (1925), Ltd.	3 & 8	Mullard Wireless Service Co., Ltd.	Cover i.	Talsmere Manf. Co.	10
Eastick, J. J. & Sons	24	Ormond Engineering Co., Ltd.	Cover iv.	Ultra Electric, Ltd.	22
Edison Swan Electric Co., Ltd.	7, 11 & 13	Overseas Trading Co.	20	Vandervell, C. A., & Co., Ltd.	9
Electradix Radios	19	Parker, W. H.	24	Westinghouse Brake & Saxby Signal Co., Ltd.	5
Epoch Radio Manf. Co., Ltd.	23	Perseus Manf. Co.	18	Wilkins & Wright, Ltd.	Cover i.
Ever Ready Co. (G.B.), Ltd.	Cover ii.	Pertrix, Ltd.	4	Wingrove & Rogers, Ltd.	18
Exact Mfg. Co.	24	Philipson & Co., Ltd.	16	Wright & Weaire, Ltd.	8

# THE TONEX HAVE PRODUCED IT

The Unit for the Screened-grid Valve!

## THE TONEX UNIBOX



Price 30/- Each

UNIBOX is to the screened-grid circuit what TONATUNA is to the detector L.F. circuit. It is an absolutely complete shielded coil unit for a screened-grid valve receiver and is the very thing that has been wanted for a long time. All the coils are enclosed in a metal case attractively finished in crystalline enamel. The screened-grid valve itself fits into the case—and in addition an extra shield can be fitted for isolating the aerial tuning condenser from the rest of the circuit. The coils cover long and short wave broadcasting bands and a self contained change-over switch is provided. The UNIBOX contains all the essential parts of the screened-grid circuit, the addition of tuning condensers and a few other components being all that are required to build a complete receiver.

### THE TONEX H.F. CHOKE

A choke that defies competition. Sectional windings enclosed in a handsome moulded Bakelite case. Handy terminals with screw-driver slots are fitted, and soldering tags are provided also. Fixing holes are metal bushed.



3 TYPES—

10-90 metres	3/6.
30-3,000 metres	4/6.
Centre Tapped	5/6.

### THE TONEX TONATUNA

The well-known tuning coil that has achieved remarkable popularity. No coils to change and a simple turn of the centre knob switches over from short waves to long waves. Aerial coil is centre tapped for increased selectivity. Range 240 to 520 metres and 1,100 to 2,000 metres.



Price 21/-

*If your dealer does not stock, write direct giving his name and address—*

**THE TONEX Co.**  
WALKER STREET, BLACKPOOL.

## ESSENTIAL FOR MAINS RECEIVERS

Look at it—completely insulated, essential where high voltages are concerned—ample contacts—impossible to burn out valves. *The first plug and socket in which both parts are engraved and entirely insulated when connected or disconnected. Engravings on both Plug and Socket make for easy connections.*



Price 9d.  
(Panel Portion 3d.)  
(Flex Portion 6d.)

Ask your dealer, or send to us, for Belling-Lee Handbook "Radio Connections."

### BELLING-LEE

FOR EVERY RADIO CONNECTION

Advertisement of Belling & Lee Ltd.,  
Queensway Whs., Ponders End, Mdx.

## BERCLIF

### "EVERYMAN FOUR" CONVERSION

L.W. COILS AND BASES	34/6
CONVERSION S.W. COILS	10/6

Particulars and detail prices post free. TRADE SUPPLIED.

**SIMMONDS BROS.,**  
SHIRELAND ROAD, SMETHWICK.

## EXACT TUNERS

230 to 2,000 metres.

No further coils are required, tuning is as simple as A.B.C., see "Wireless World," January 25th. "We can strongly recommend these Tuners." Send postcard for particulars and Circuits FREE to:

**THE EXACT MANUFACTURING CO.**  
Croft Works, Priory Place, COVENTRY.

## METAL CABINETS

for the 1930 Everyman Four, Kilo Mag 4 and Record III.

**PRICE 27/6** with four Compartments.  
Also for the WIRELESS WORLD KIT SET  
**PRICE 22/6** with two Compartments.

*Trade enquiries invited.*

**W. H. PARKER,**  
Aircraft & Wireless Sheet Metal Worker,  
BACK AUTUMN TERRACE, LEEDS.

## EELEX

2DH

2DS		SPADES and PINS HOOKS and EYES
2DP		6 Colours .. 2d. each.
2DI		Write for List X94

J. J. EASTICK & SONS,  
118 Bunhill Row, London, E.C.1.

## TILTRACK

Registered Trade Mark  
Patent-STEEL STORES System

For the Wireless Experimenter, Factory, Factor and Retailer,  
Full Particulars from Sol. Manufacturer and Patentees:—  
**BERTRAM THOMAS,** Worsley Street, Hulme, MANCHESTER.

## A 6d Insurance Policy

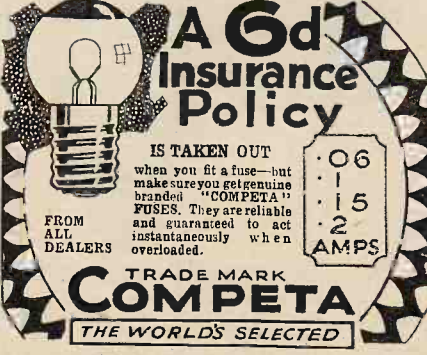

IS TAKEN OUT when you fit a fuse—but make sure you get genuine branded "COMPETA" FUSES. They are reliable and guaranteed to act instantaneously when overloaded.

FROM ALL DEALERS

TRADE MARK  
**COMPETA**  
THE WORLD'S SELECTED

06  
15  
2  
AMPS

Advt. of A. F. BULGIN & Co., 9/10/11 Curator St., London, E.C.4.

Mention of "The Wireless World," when writing to advertisers, will ensure prompt attention.

# BAYLISS ROTARY CONVERTER

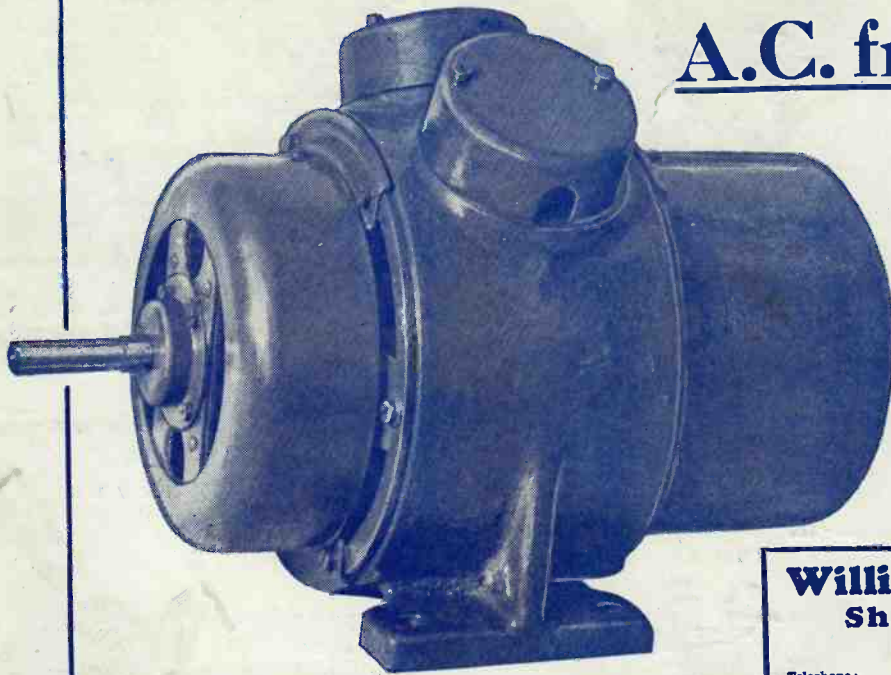

## A.C. from D.C.

Load 400 Watts.

ANY Input.  
ANY Output.

PRICE

### £12. 10. 0

Delivery  
from Stock.

**William Bayliss Ltd.**  
Sheepcote Street  
**BIRMINGHAM**

Telephone:  
Mid 1408.

Telegrams:  
"Drawbench, B'ham."

# Radio's Supreme Power



ARE YOU PROUD  
OF YOUR NEW SET?  
DO IT JUSTICE  
AND FIT THE BEST  
POSSIBLE BATTERY

Grosvenor Batteries give continuous and satisfactory service because they incorporate a new vitalising element which is unique to Grosvenor.

66 v. from 7/6      Super Capacity for Multi-Valve Sets      66 v. 20/-  
99 v. .. 11/6                                    99 v. 32/6



# The Grosvenor Battery

BRITISH MANUFACTURE

GROSVENOR BATTERY CO., LTD., 2-3, White St., MOORGATE, LONDON, E.C.2. Phone. Met. 6866

Advertisements for "The Wireless World" are only accepted from firms we believe to be thoroughly reliable.

# The ORMOND Popular Model LOUDSPEAKER

justly maintains  
its unique  
reputation  
for low price  
and first-  
class results



PRICE  
**29/6**  
IN OAK OR MAHOGANY

The Ormond "Popular" Loud Speaker worthily upholds the Ormond tradition for quality and value. It is indeed a product in which every owner takes exceptional pride.

Fitted with the famous Ormond 4-pole adjustable loud-speaker Unit and the Ormond "Wonder" Cone, this handsome speaker proves highly efficient, reproducing every tone with full-throated mellowness and accuracy.

An adjustment is fitted at the back of the cabinet in a readily accessible position.

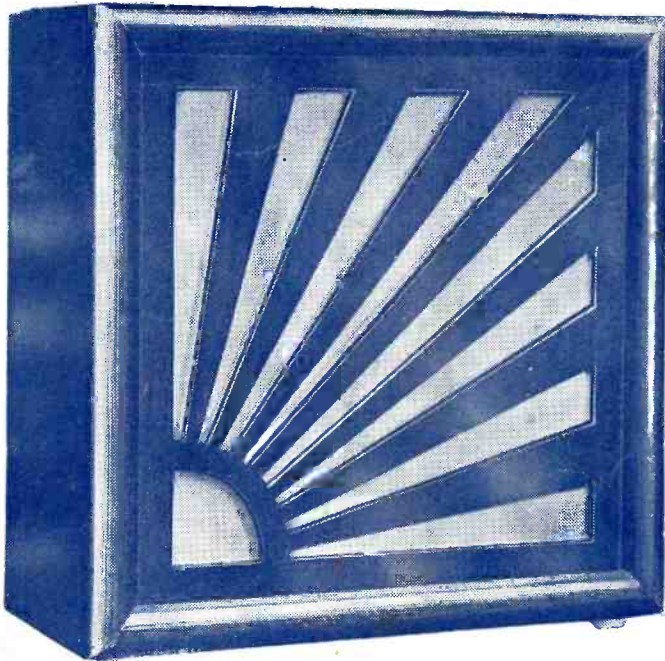

Supplied in handsome figured Oak or solid Mahogany Cabinet.  
Ask your local Radio Dealer to demonstrate this remarkable loud speaker to you.

**The  
ORMOND  
ENGINEERING  
CO., LTD.**  
Ormond House, Rosebery Ave.,  
London, E.C.1.  
Tel.: Clerkenwell 5334-5-6 & 9344-5-6.  
'Grams: "Ormondengt, Smith."

for **PUNCH, POWER  
& PURITY**

Printed for the Publishers, LIFFE & SONS LTD., Dorset House, Tudor Street, London, E.C.4, by The Cornwall Press Ltd., Paris Garden, Stamford Street, London, S.E.1.

Colonial and Foreign Agents:  
 UNITED STATES—The International News Co., 131, Varick Street, New York. FRANCE—W. H. Smith & Son, 248, Rue Rivoli, Paris; Hachette et Cie, Rue Réaumur, Paris.  
 BELGIUM—W. H. Smith & Son, 78, Marche aux Herbes, Brussels. INDIA—A. H. Wheeler & Co., Bombay, Allahabad and Calcutta. SOUTH AFRICA—Central News Agency Ltd.  
 AUSTRALIA—Gordon & Gotch, Ltd., Melbourne (Victoria), Sydney (N.S.W.), Brisbane (Queensland), Adelaide (S.A.), Perth (W.A.), and Launceston (Tasmania).  
 CANADA—The American News Co., Ltd., Toronto, Winnipeg, Vancouver, Montreal, Ottawa, St. John, Halifax, Hamilton; Gordon & Gotch, Ltd., Toronto; Imperial News Co.  
 Toronto, Montreal, Winnipeg, Vancouver, Victoria. NEW ZEALAND—Gordon & Gotch, Ltd., Wellington, Auckland, Christchurch and Dunedin.